

ZOLL[®]

 **AutoPulse**[®]

Resuscitation System Model 100

User Guide

Notice

About this Guide

The information in this User Guide applies to the ZOLL AutoPulse Resuscitation System Model 100.

ZOLL shall not be liable for errors contained herein or for incidental or consequential damages in connection with the furnishing, performance, or use of this material.

Copyright

© Copyright ZOLL Circulation, Inc. 2024. All rights reserved.

No part of this publication may be reproduced, stored in a retrieval system, or transmitted, in any form or by any means, mechanical, electronic, photocopying, recording, or otherwise, without prior written permission of ZOLL.

AutoPulse and LifeBand[®] are trademarks of ZOLL. All other trademarks mentioned herein belong to their respective owners.

Patent: www.zoll.com/patents



 USA
ZOLL Circulation, Inc.
2000 Ringwood Avenue
San Jose, CA 95131 U.S.A.

+1 (408) 541-2140 (*main*)
+1 (408) 541-1030 (*fax*)



EU Authorized Representative
ZOLL International Holding B.V.
Einsteinweg 8A
6662 PW ELST
The Netherlands



ZOLL Medical Switzerland
Baarerstrasse 8
6300, Zug Switzerland

Table of Contents

Figures	v
Tables	vii
Preface	ix
Who Should Read this Guide	ix
General Warnings and Precautions	ix
Symbols	xi
1 Introduction of the AutoPulse® System	1-1
1.1 Indication for Use	1-1
1.2 Description of the System	1-1
1.3 System Components	1-2
1.3.1 Platform	1-2
1.3.2 LifeBand Load-distributing Band	1-3
1.3.3 AutoPulse Power System	1-3
1.4 User Controls and Indicators	1-4
1.4.1 On/Off Button	1-4
1.4.1.1 On/Off Button	1-4
1.4.2 User Controls	1-4
1.4.2.1 Start/Continue Button	1-5
1.4.2.2 Stop/Cancel Button	1-5
1.4.2.3 Menu/Mode Switch Button	1-6
1.4.2.4 Move Up/Move Down Button	1-6
1.4.2.5 Select Choice Button	1-7
1.4.2.6 Tone Mute Button	1-7
1.4.2.7 Increase/Decrease Contrast Button	1-8
1.4.2.8 Power (Green LED)	1-8
1.4.2.9 Alert (Red LED)	1-8
1.4.3 Battery Charge Status	1-8
1.4.4 Performance Characteristics	1-10
2 Preparing the AutoPulse System for Use	2-1
2.1 LifeBand Load-distributing Band	2-1
2.1.1 Installing the LifeBand	2-1
2.1.2 Removing the LifeBand	2-4
2.1.2.1 Removing a LifeBand that is Cut or Not in the Home Position	2-7
2.2 Battery Installation and Removal	2-9
2.2.1 AutoPulse Li-Ion Battery Installation and Removal	2-9
2.3 Administrative Menu: User Pre-set Options	2-10
3 Using the AutoPulse System	3-1
3.1 Deploying the AutoPulse System	3-1

3.2 Starting Chest Compressions	3-7
3.3 Ending Active Device Use	3-14
3.4 Preparing the Platform for Its Next Use	3-14
3.5 Periodic Electrocardiogram (ECG) Monitoring and/or Defibrillation	3-14
3.6 Patient Alignment and Securing for Transport	3-15
3.6.1 Recommended Method of Patient Extrication	3-16
3.7 Viewing Platform Information	3-18
3.8 Uploading Platform Information to your PC	3-19
3.8.1 Information Upload Procedure	3-20
4 Maintaining the AutoPulse System	4-1
4.1 Charging Batteries in the Battery Charger	4-1
4.2 Cleaning the Platform	4-2
4.3 Storing the Platform	4-3
4.4 Maintenance	4-3
4.5 Disposal and Recycling	4-5
4.5.1 Platform	4-5
4.5.2 Battery Charger	4-5
4.5.3 Batteries	4-5
4.5.4 LifeBand	4-5
5 Troubleshooting Procedures	5-1
5.1 Troubleshooting Batteries	5-1
5.2 Troubleshooting User Advisories and Faults	5-2
5.2.1 User Advisory (45)	5-4
5.3 Troubleshooting Errors	5-5
Appendix A AutoPulse Daily Checklist	A-1
Appendix B Technical Specifications	B-1
B.1 Patient Parameters	B-1
B.2 LifeBand	B-1
B.3 Operating Parameters	B-1
B.4 Platform Physical	B-1
B.5 Platform Environmental	B-2
B.6 Li-Ion Battery Physical and Environmental	B-2
B.7 Battery Charger Physical And Environmental	B-4
B.8 FCC Statement	B-6
B.9 Guidance and Manufacturer’s Declaration–Electromagnetic Emissions	B-6
B.10 Limited Warranty for AutoPulse Resuscitation System	B-11
Index	I-1

Figures

Figure 1-1 The AutoPulse System	1-2
Figure 1-2 Platform (Patient and Back Surfaces)	1-3
Figure 1-3 On/Off Button Location	1-4
Figure 1-4 User Control Panel	1-5
Figure 1-5 Low Battery Warning	1-9
Figure 2-1 Sliding the LifeBand Band Clip into the Driveshaft Slot	2-1
Figure 2-2 Seating the LifeBand Band Clip Properly into the Driveshaft Slot	2-2
Figure 2-3 Snapping the LifeBand Cover Plate into Place	2-3
Figure 2-4 Flip Down the Hinged Belt Guards of the LifeBand	2-3
Figure 2-5 Flip Up the Hinged Belt Guards of the LifeBand	2-4
Figure 2-6 Pinching the Locking Tabs of the LifeBand	2-5
Figure 2-7 Removing the LifeBand from the Platform	2-6
Figure 2-8 LifeBand NOT in the Home Position: Do Not Remove!	2-7
Figure 2-9 Positioning the LifeBand for Removal	2-8
Figure 2-10 LifeBand in the Home Position: Ready for Removal	2-8
Figure 2-11 AutoPulse Li-Ion Battery Installation and Removal	2-9
Figure 2-12 Administrative Menu	2-11
Figure 2-13 Administrative Menu (scrolled down)	2-11
Figure 2-14 Compression Mode Menu	2-12
Figure 2-15 Mute Duration Menu	2-13
Figure 2-16 Ventilation/Pause Tone Volume Menu	2-14
Figure 2-17 Continuous Mode Ventilation Tone Menu	2-15
Figure 3-1 On/Off Button Location	3-1
Figure 3-2 Self-Test Display Panel Screen	3-2
Figure 3-3 Patient-Readiness Display Panel Screen	3-2
Figure 3-4 Cutting Patient Clothing and Positioning of AutoPulse	3-3
Figure 3-5 Removal of all Clothing from the Torso	3-4
Figure 3-6 Correct Patient Alignment	3-5
Figure 3-7 Aligning the LifeBand	3-6
Figure 3-8 Fastening the LifeBand	3-7
Figure 3-9 Analyzing Patient Size Display Panel Screen	3-8
Figure 3-10 Verifying Patient Alignment Display Panel Screen	3-9
Figure 3-11 Chest Compression Display Panel Screen	3-10
Figure 3-12 Ventilation Pause Display Panel Screen	3-11
Figure 3-13 Mode Change Confirm Display Panel Screen	3-12
Figure 3-14 Stopping Compressions Display Panel Screen	3-13
Figure 3-15 Restart/Continue Compressions Display Panel Screen	3-13
Figure 3-16 Securing the Patient for Transport	3-16
Figure 3-17 Transporting the Patient	3-17
Figure 3-18 Main Menu	3-20
Figure 3-19 Infrared Communication Set-up	3-20
Figure 3-20 Waiting for Connection... Display Panel Screen	3-21

Figure 3-21 Connected Display Panel Screen	3-21
Figure 3-22 Transmitting... Display Panel Screen	3-22
Figure 4-1 Battery Charger with Charging Bay	4-1
Figure 4-2 Battery Charger Control Panel	4-2
Figure 5-1 Low Battery Warning	5-1
Figure 5-2 Replace Battery Screen	5-2
Figure 5-3 A User Advisory Screen	5-3
Figure 5-4 A Fault Screen	5-3
Figure 5-5 User Advisory (45)	5-4
Figure 5-6 System Error Screen	5-5

Tables

Table 1-1 Patient/AutoPulse System Operating Parameters	1-1
Table 1-2 Battery Charge Status Indicator Specifics	1-10
Table 1-3 Operating Characteristics	1-10
Table B-1 Operating Parameters	B-1
Table B-2 Physical Specifications	B-1
Table B-3 Environmental Specifications	B-2
Table B-4 Li-Ion Battery Specifications	B-2
Table B-5 Battery Charger Specifications	B-4
Table B-6 Guidance and Manufacturer’s Declaration–Electromagnetic Emissions	B-6
Table B-7 Guidance and Manufacturer’s declaration – Electromagnetic immunity for Platform	B-7
Table B-8 Guidance and manufacturer’s declaration – electromagnetic immunity	B-8
Table B-9 Recommended separation distances between portable and mobile RF communications equipment and the Platform	B-9

[This page left intentionally blank.]

Preface

This document describes the operating steps and maintenance requirements for the AutoPulse® Resuscitation System Model 100.

Proper use of the AutoPulse System requires a thorough understanding of the product, appropriate training and practice.

Please read the entire *User Guide* before operating the AutoPulse System.

Who Should Read this Guide

This document should be read by personnel who will use this product and who are trained in Basic Life Support (BLS) and/or Advanced Life Support (ALS) techniques. This includes emergency medical technicians, paramedics, nurses, physicians, police, and fire rescue personnel, and people certified to administer cardiopulmonary resuscitation (CPR).

General Warnings and Precautions

Warning:

- The AutoPulse System is intended for use on adults, 18 years of age or older.
- The AutoPulse System is **not** intended for patients with traumatic injury (wounds resulting from sudden physical injury or violence).
- When CPR is indicated, it should start immediately and should not be postponed.
- The AutoPulse System must be used **only** in cases that manual CPR would normally be initiated. Personnel certified in manual CPR must always be present during the AutoPulse System operation.
- The AutoPulse Platform is **not** intended to be the sole means of carrying a patient. The AutoPulse Platform should be secured to the top of a backboard or other equipment used to carry or transport the patient such as the AutoPulse Quick Case or AutoPulse Soft Stretcher, if necessary. During transport, regular checks of the patient's alignment should be performed.

Warning:

- If a user advisory or fault cannot be cleared or a system error occurs during active operation, immediately revert to manual CPR.
- Operating the Platform on a patient for extended periods of time may result in minor skin irritation to the patient.
- Do not use the Platform in the presence of an oxygen-rich (greater than 25% oxygen) atmosphere, flammable anesthetics, or other flammable agents (such as gasoline). Using the Platform near the site of a gasoline spill may cause an explosion.
- To avoid the risk of electric shock, connect the AutoPulse Multi-Chemistry Battery Charger (Battery Charger) only to a supply mains with protective earth.
- Always charge a new Battery upon receipt. Failure to charge a Battery may cause reduced Battery performance.
- Always charge a stored Battery before placing the Battery into active operation. The Battery slowly self-discharges when not in use. Failure to charge a Battery before use may cause device power failure. In no case should any Battery be used if it has not been charged within the previous 60 days.
- No modification of the AutoPulse Platform, the LifeBand, or the AutoPulse Power System is allowed.

Caution: United States federal law restricts this device to sale by or on the order of a licensed physician.

Caution: The AutoPulse System is designed to be used only with ZOLL-approved accessories. The AutoPulse System will perform improperly if non-approved accessories are used.

Caution: Only use ZOLL Batteries specifically designed for use with the AutoPulse System. The use of other batteries may cause permanent damage to the AutoPulse System and will void the warranty.

Caution: Do not store an AutoPulse Battery in an unpowered Battery Charger (unplugged or AC power is off). Irreversible damage to the Batteries occurs within 10 days, depending on the initial state of charge.

Caution: Do not autoclave the Platform, the LifeBand, or the AutoPulse Power System.









Caution: Retain the original product literature for future reference.







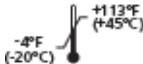





Caution: Do not use or stack the unit with other equipment. If the unit is used or stacked with other electrical equipment, verify proper operation before using it.

Caution: Any serious incident that has occurred in relation to the device should be reported to the manufacturer and the competent authority of the Member State in which the user and/or patient is established.

Symbols

The symbols below may be found in this *User Guide*, on the Platform, the LifeBand, the Multi-Chemistry Battery Charger (Battery Charger), or Li-Ion Battery.

	Follow instructions for use
	Date of Manufacture
	Manufacturer
	Authorized Representative
SN	Serial Number
	Defibrillation Protected, Type BF Patient Connection
IP25	Degree of Protection Provided by Enclosure Per IEC 60529
	Do Not Reuse—Single Use Only
	Recycle
	Temperature Limitations
	Dispose of in accordance with local governing ordinances and recycling plans for lithium ion batteries.
	Rechargeable Battery

	Do Not Incinerate
	Fuse
	DC Voltage
	Caution: Charging
	Ready
	Fail
	Test Cycle
	Power
	Caution
	Catalog number
RX ONLY	Prescription use only
	Importer
	Medical device

1 Introduction of the AutoPulse® System

The AutoPulse System is an automatic cardiopulmonary resuscitation (CPR) product.

1.1 Indication for Use

The AutoPulse is intended to be used as an adjunct to manual CPR, on adult patients only, in cases of clinical death as defined by a lack of spontaneous breathing and pulse.

1.2 Description of the System

The Platform is an automated, portable, battery-powered chest compressor, which provides chest compressions as an adjunct to performing manual CPR (see Figure 1-1). Use of the AutoPulse System is intended to reduce the impact of rescuer fatigue and will enable the rescuer to address additional patient needs.

The AutoPulse System has the following operating parameters:

- Chest displacement: equal to 20% reduction in anterior-posterior chest depth.
- Consistent compression rate and depth.
- Physiological duty cycle: fixed at $50 \pm 5\%$.

Standardized 30:2, or 15:2 compressions (30 or 15 compressions followed by two consecutive 1.5 second ventilation pauses) or continuous compressions (user selectable).

Table 1-1 Patient/AutoPulse System Operating Parameters

Patient Parameter	AutoPulse Specification
Patient chest circumference permitted	29.9 to 51.2 in. (76 to 130 cm)
Patient chest width permitted	9.8 to 15 in. (25 to 38 cm)
Maximum patient weight permitted	300 lbs.(136 kg)

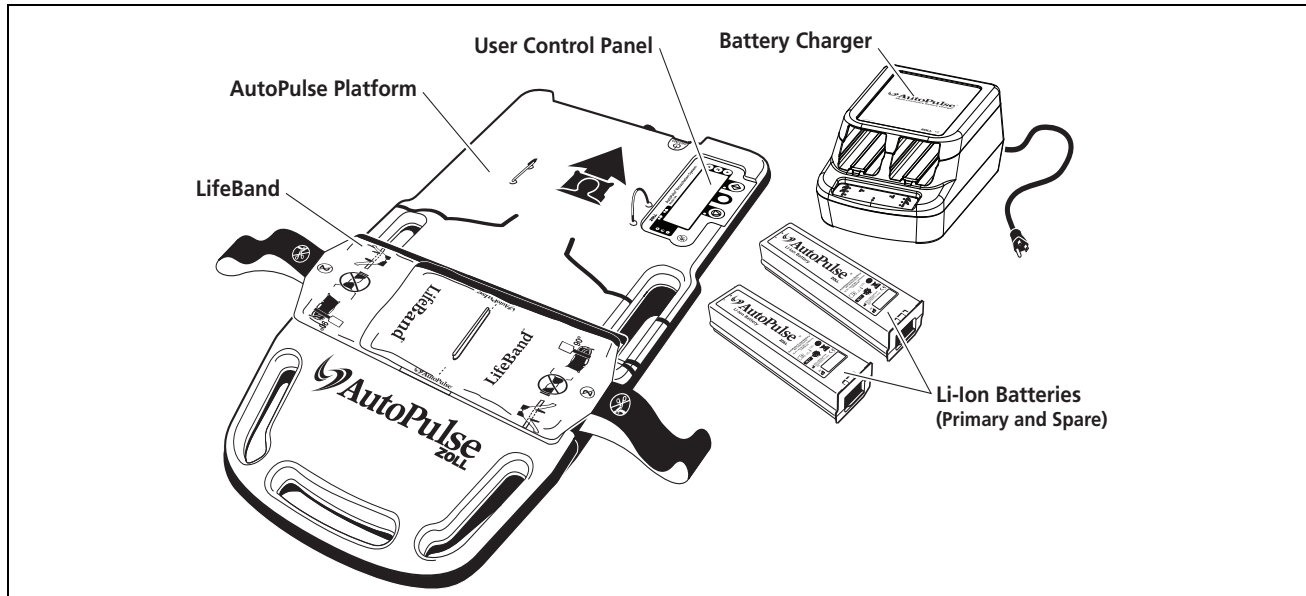

Figure 1-1 *The AutoPulse System*

1.3 **System Components**

Figure 1-1 shows the main components of the AutoPulse System.

The AutoPulse System consists of the following:

- Platform
- LifeBand
- Power System

1.3.1 **Platform**

The Platform contains the mechanical drive mechanism, control system, and electronics necessary to generate and control the force required to perform mechanical chest compressions. User controls and indicators are contained in the User Control Panel.

Figure 1-2 shows the patient surface (front) and back surface details of the Platform. The Platform features carry handles to facilitate transporting it to the scene of the arrest.

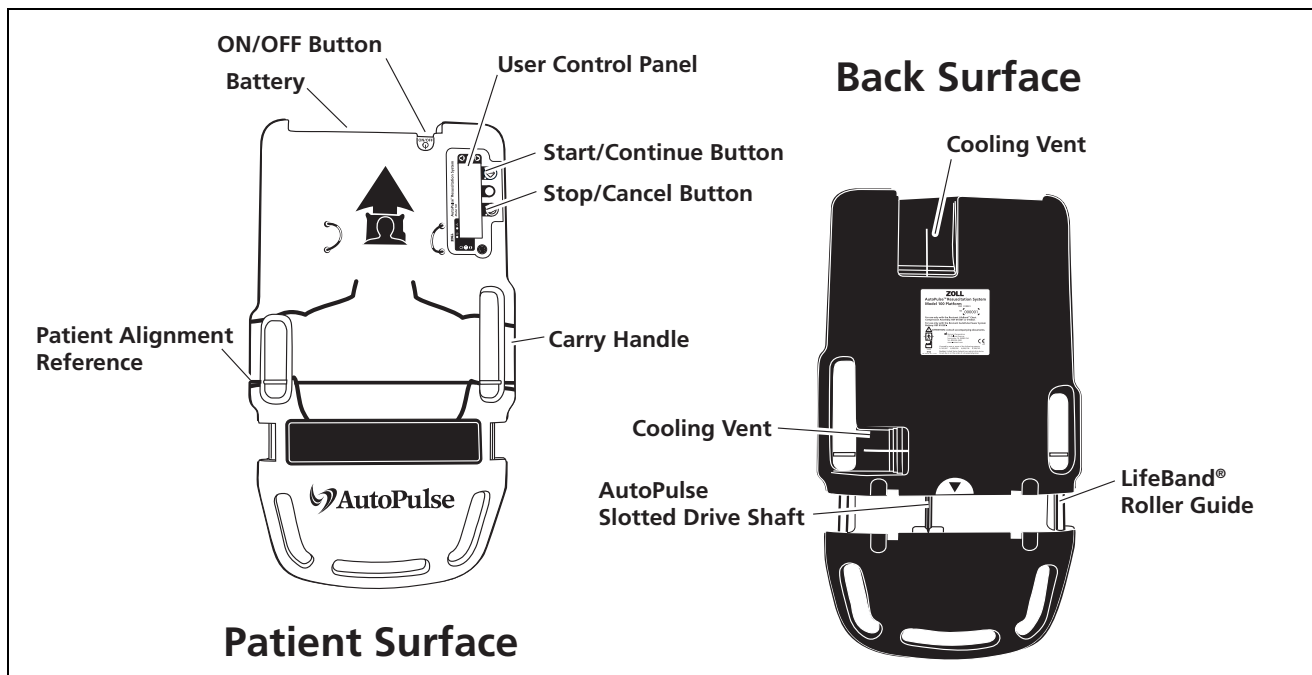

Figure 1-2 Platform (Patient and Back Surfaces)

1.3.2 LifeBand Load-distributing Band

The LifeBand is a load-distributing band that consists of a cover plate and two bands integrated with a compression pad with a Velcro® fastener. Attached to the Platform, the LifeBand is automatically adjusted to the patient and provides compressions to the patient's chest in the region of the heart. The latex-free LifeBand is a single-use component that is attached to the Platform before each use.

Note: The LifeBand and the patient surface of the Platform (Figure 1-2) together comprise the “applied parts” (as defined by IEC 60601-1, 3rd ed.), i.e., the part of the system that in normal use necessarily comes into physical contact with the patient.

1.3.3 AutoPulse Power System

The AutoPulse Power System consists of a battery and battery charger:

- Battery: the AutoPulse Li-Ion Battery (a Lithium-Ion battery)
- Battery charger: the Multi-Chemistry Battery Charger

Battery: The AutoPulse Li-Ion Battery is a proprietary, rechargeable, removable battery designed to supply power for AutoPulse operation. The Battery is mechanically keyed to the Platform and to the Battery Charger to facilitate correct installation. One end of the Battery contains connections for power and communication to the Battery Charger and to the Platform. A Battery Status Check button illuminates the Battery’s status light-emitting diodes (LED’s).

Battery Charger: The Battery Charger is a stand alone unit designed to charge and automatically maintain the Li-Ion Battery. The Battery Charger has two charging bays, and each bay has its own indicators.

The Battery should always be properly maintained and be fully charged and ready for use before deploying the AutoPulse.

For more information, refer to the *AutoPulse Power System User Guide*.

1.4 User Controls and Indicators

1.4.1 On/Off Button

The On/Off button is located adjacent to the Battery on the Platform (see Figure 1-3).

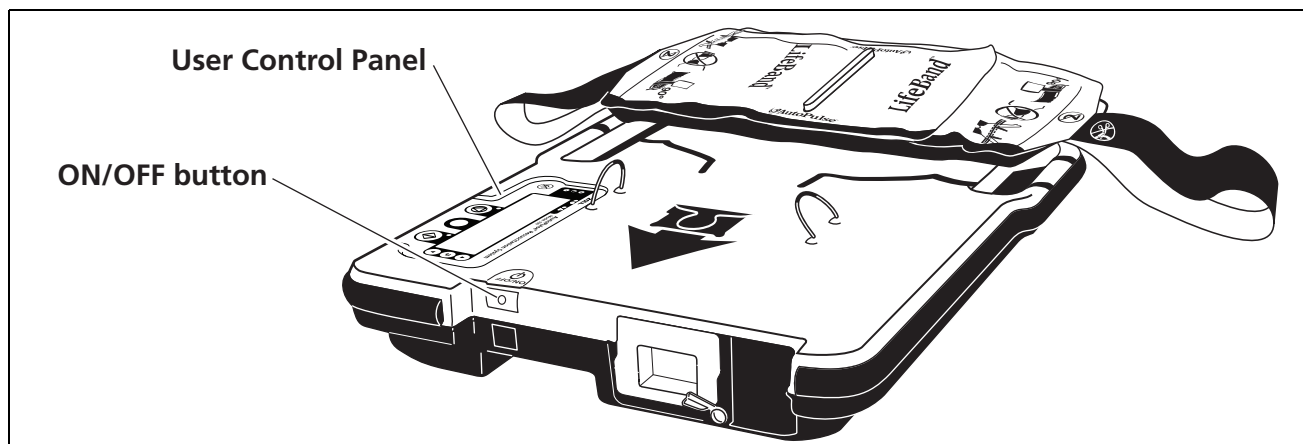

Figure 1-3 On/Off Button Location

1.4.1.1 On/Off Button



When the AutoPulse Battery is inserted into the AutoPulse Platform, the Platform is in “stand-by”, and ready for activation by the On/Off button. Pressing the On/Off button once then powers up the Platform and initiates a self-test. The User Control Panel's green Power LED lights up. Pressing the On/Off button again powers down the Platform and returns it to “stand-by”.

1.4.2 User Controls

All user controls and indicators (except the On/Off button) are contained in User Control Panel (see Figure 1-4).

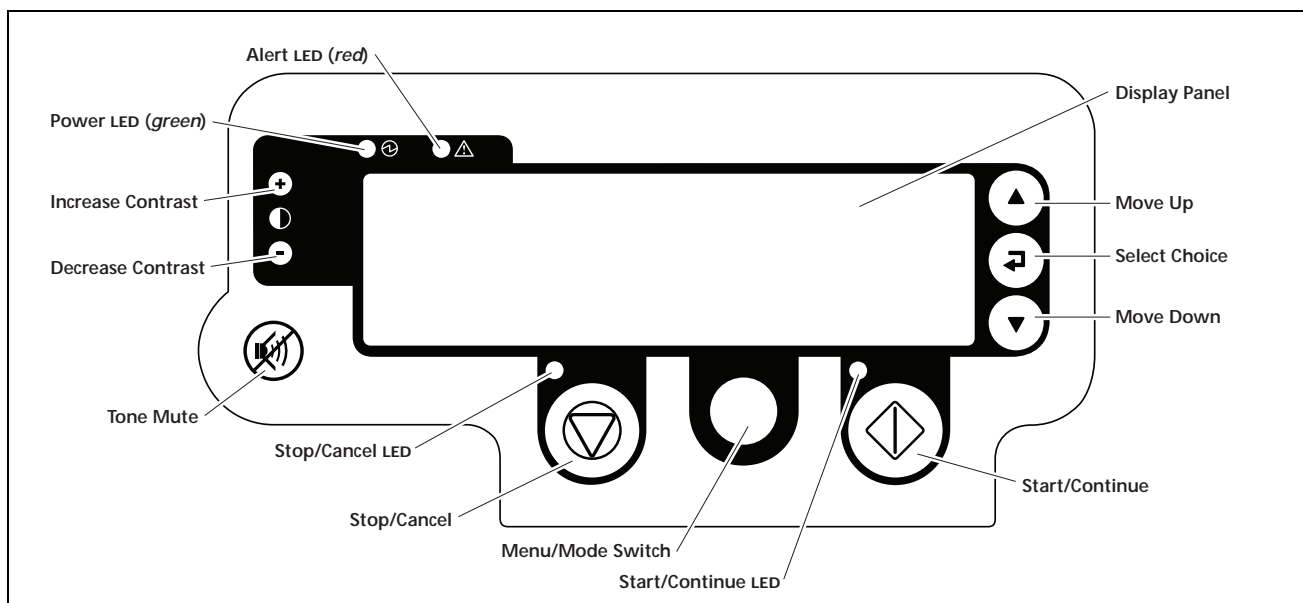
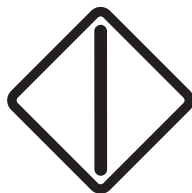

Figure 1-4 User Control Panel

1.4.2.1 Start/Continue Button



The green Start/Continue button is active when “Start” or “Continue” appears on the display panel above the button and its green LED is illuminated.

Use the Start/Continue button to start or continue:

- Analyzing patient size
- Chest compressions

1.4.2.2 Stop/Cancel Button

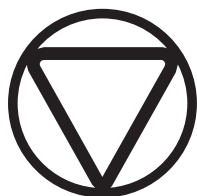

The orange Stop/Cancel button is active when “Stop”, “Quit”, or “Cancel” appears on the display panel above the button and its orange LED is illuminated.

Use the Stop/Cancel button to stop or cancel:

- Analyzing patient size (see Figure 3-9)
- Chest compressions (the Platform releases the tension on the LifeBand) (see Figure 3-11)
- Verify patient alignment pause (see Figure 3-10)

1.4.2.3 Menu/Mode Switch Button

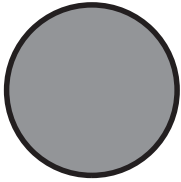

On initial power-up the gray Menu/Mode Switch button functions as the Menu button. Pressing this button allows you to:

1. Enter the communication mode
2. View last patient session information
3. View AutoPulse Platform information
4. View AutoPulse Battery information

For a complete description of the available information and how to access it, refer to section Section 3.7, “Viewing Platform Information,” on page 3-18. For more information on the Communication Mode, see Section 3.8, “Uploading Platform Information to your PC,” on page 3-19.

While the Platform is actively doing compressions this button may function as the Mode Switch button. The Mode Switching feature is only active when the “30:2 or Continuous” or “15:2 or Continuous” option has been set in Mode section of the Administration Set-up (refer to section Section 2.3, “Administrative Menu: User Pre-set Options,” on page 2-10). If the “30:2 or Continuous” or “15:2 or Continuous” option has been set, the Mode Switch button will allow you to switch *on-the-fly* between 30:2 and Continuous or 15:2 and Continuous compression modes respectively.

The current mode (either “30:2”, “15:2” or “CONTINUOUS”) is displayed on the upper left portion of the User Control Panel.

1.4.2.4 Move Up/Move Down Button



These buttons allow you to highlight for selection different menu or list items.

Pressing the Move Up button (upward pointing triangle) moves up to the next menu item.



Pressing the Move Down button (downward pointing triangle) moves down to the next menu item.

1.4.2.5 Select Choice Button



Pressing the Select Choice button selects the currently highlighted menu or list item.

1.4.2.6 Tone Mute Button



The ventilation and pause tones are always generated at the appropriate times by the system and cannot be turned off, but they can be muted for a short period of time as set in the Administration Menu (refer to section Section 2.3, “Administrative Menu: User Pre-set Options,” on page 2-10). Selecting the Tone Mute button will mute or enable the audible tone feedback generated by the Platform. When the audio feedback is audible, pressing the Tone Mute button will mute it. When the audio feedback is muted, pressing the Tone Mute button will make it audible once again.

Once audio feedback has been muted with the Tone Mute button, it will automatically be reactivated when one of the following occurs:

1. The Mute Duration time set in the Administrative Menu has expired.
2. You press the Tone Mute button again.
3. You press the Start/Continue button to begin compressions.
4. You press the Stop button during compressions.
5. A low battery condition is reached (refer to Figure 1-5 on page 1-9).
6. You switch between compression modes (refer to Figure 3-13 on page 3-12).



The icon displayed on the User Control Panel display when tones are audible.



The icon displayed on the User Control Panel display when tones are muted.

1.4.2.7 Increase/Decrease Contrast Button



Pressing the Increase Contrast button (plus sign) increases the contrast of the display panel screen. Each key press increases the contrast of the display panel screen by one level.



There are a total of eight contrast levels.



Pressing the Decrease Contrast button (minus sign) decreases the contrast of the display panel screen. Each key press decreases the contrast of the display panel screen by one level.

You can adjust the contrast of the display panel screen at any time the AutoPulse Platform is powered up.

1.4.2.8 Power (Green LED)

The green Power LED lights whenever the Platform is powered on and able to respond to user input.

1.4.2.9 Alert (Red LED)

The red Alert LED lights whenever a user advisory, fault or system error condition exists for the Platform. For a list of advisory, fault and error conditions, refer to Chapter 5, “Troubleshooting Procedures”.

1.4.3 Battery Charge Status

The User Control Panel displays the battery charge status. The Battery charge status icon only appears when the Platform is powered up.



Indicates the level of charge of the Battery. A graphic battery icon indicating four proportional levels of battery charge is displayed.

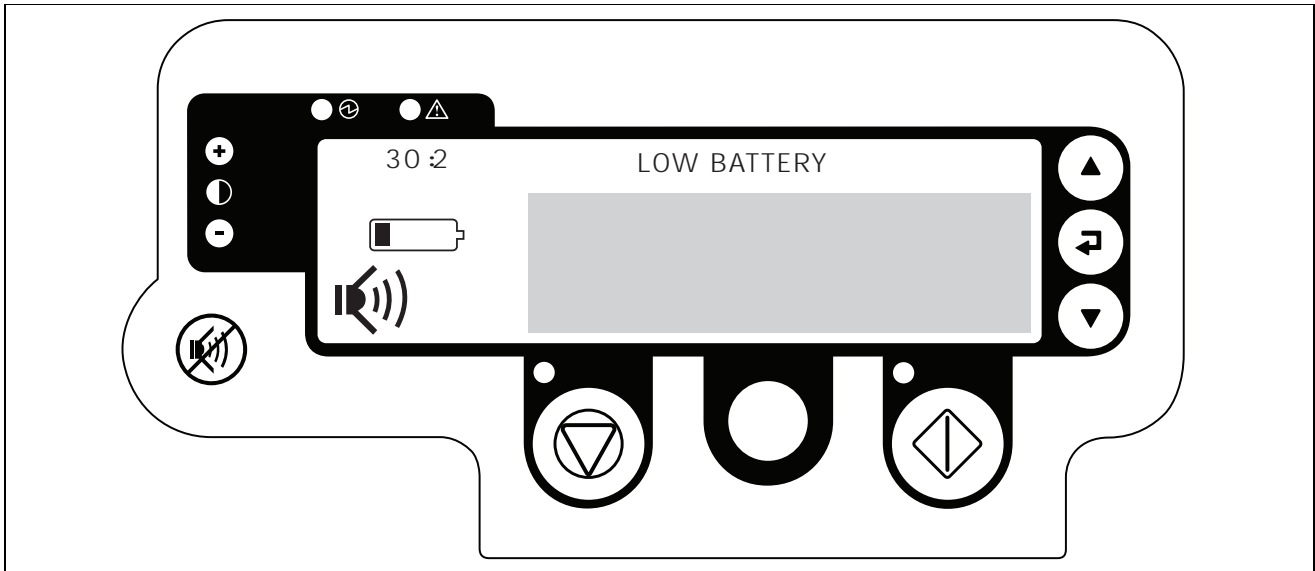







Figure 1-5 Low Battery Warning

When five minutes of active operation remain on a Battery, the User Control Panel will give a “Low Battery” indication (see Figure 1-5). The “Low Battery” indication will remain on until the Battery is replaced or depleted. The Low Battery warning display will be accompanied with an audio warning of four rapid beeps which will be followed by two beeps every 30 seconds until the battery is replaced or depleted. It is recommended that, if available, a fully-charged Battery be exchanged for the Battery with the low charge.

To exchange Batteries:

1. Press the Stop/Cancel button.
2. Press the On/Off button.
3. Remove the Battery (refer to Section 2.2, “Battery Installation and Removal” for more information).
4. Install the fully-charged Battery (refer to Section 2.2, “Battery Installation and Removal” for more information).
5. Resume chest compressions (refer to Section 3.2, “Starting Chest Compressions” for more information).

Table 1-2 Battery Charge Status Indicator Specifics

Battery Charge Icon	Bars Showing	Charge Level
	No bars showing.	The Battery has been depleted. Replace the Battery immediately.
	One bar showing.	The Battery's capacity is less than one-third of a full charge. Be prepared to exchange this Battery with a fully-charged Battery.
	Two bars showing.	The Battery's capacity is between 33% and 66% of a full charge.
	Three bars showing.	The Battery's capacity is between 66% and 100% of a full charge.
	All bars showing.	The Battery is fully charged.

1.4.4 Performance Characteristics

The basic operating characteristics of the Platform are shown in Table 1-3.

Table 1-3 Operating Characteristics

Operating Performance	Specification
Compression rate	80 (\pm 5 compressions per minute)
Compression modes (user selectable)	<ul style="list-style-type: none"> • 30:2 (30 compressions with two 1.5 second ventilation pauses) • Continuous compressions
Duty cycle	50 (\pm 5%)
Compression depth	20% of chest depth, +0.25/-0.5 inch

2 Preparing the AutoPulse System for Use

The AutoPulse System is delivered fully assembled, except for the LifeBand and the AutoPulse Battery.

2.1 LifeBand Load-distributing Band

Note: Do **not** cut the LifeBand before removing it from the Platform. Cutting the LifeBand may cause the Platform to report a Fault and will require specific steps to clear that Fault.

2.1.1 Installing the LifeBand

1. Power off the device.
2. Place the Platform with the patient surface facing down on a smooth, flat surface.

Note: The driveshaft should be oriented so that the slot faces directly upward.

3. **1** Insert the head end of the LifeBand band clip into the driveshaft slot. The correct direction is towards the LifeBand plate alignment arrow seen on the Platform (see Figure 2-1).

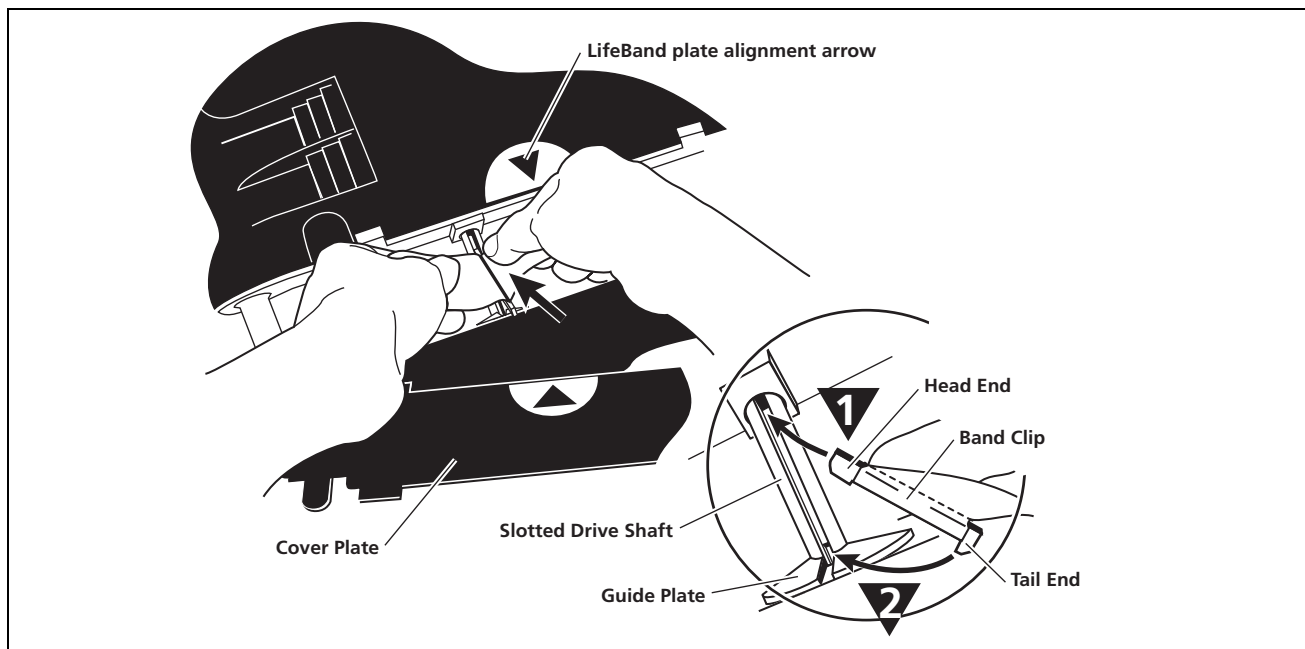

Figure 2-1 Sliding the LifeBand Band Clip into the Driveshaft Slot

4. **2** Once the head end of the LifeBand band clip is positioned into the slot, press the tail end of the band clip into the slot of the guide plate until the band clip is fully seated in the driveshaft. You should feel it lock into place.

5. Make sure that the band clip is seated properly and fully into the slot on the driveshaft (see Figure 2-2).

Note: If the band clip is properly seated, you should be able to turn the driveshaft in each direction by hand.

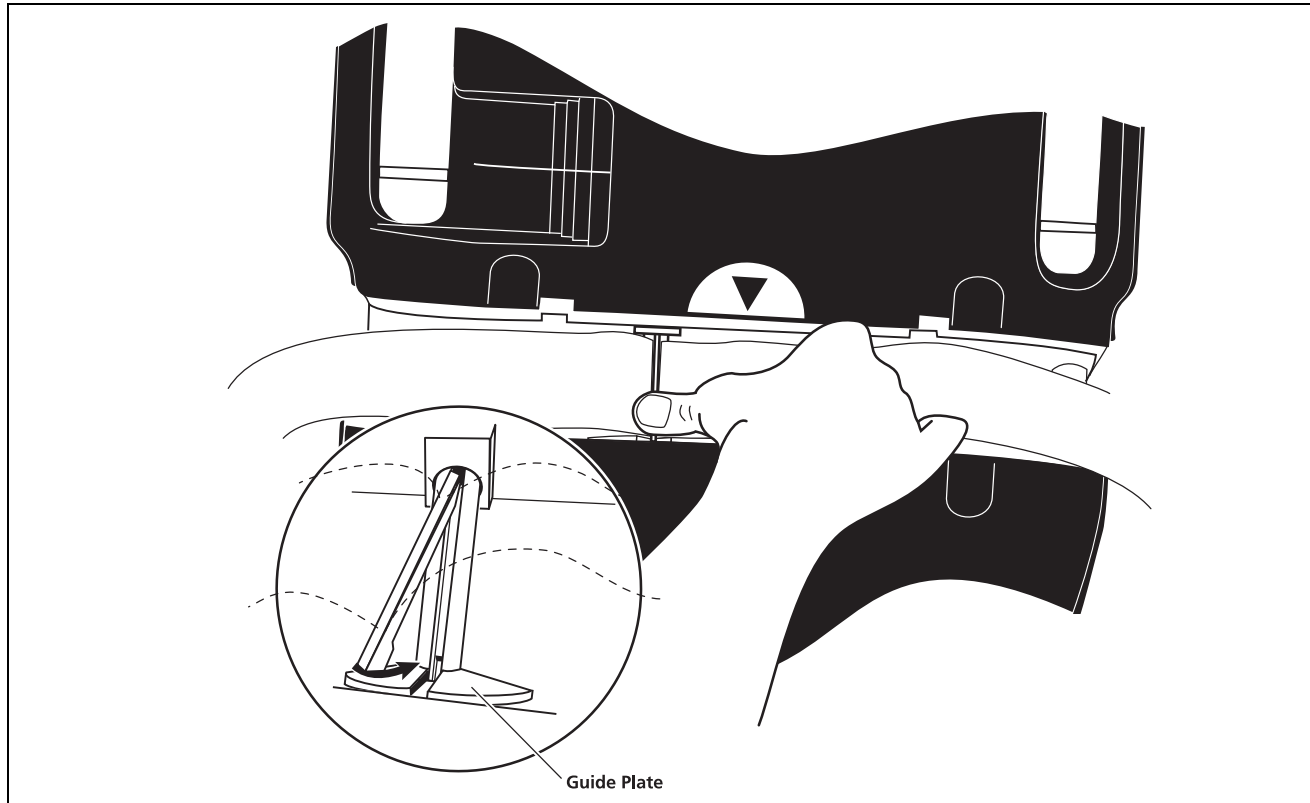

Figure 2-2 *Seating the LifeBand Band Clip Properly into the Driveshaft Slot*

6. Ensure that both free ends of the LifeBand are oriented flat (not twisted) and away from the AutoPulse Platform. Inspect the LifeBand for any cuts or tears. Do not use the LifeBand if cuts or tears are present.
7. Line up the arrow on the LifeBand cover plate with the matching arrow on the Platform.
8. Snap the LifeBand cover plate in place by fully inserting the locking tabs into the slots on the Platform (see Figure 2-3).

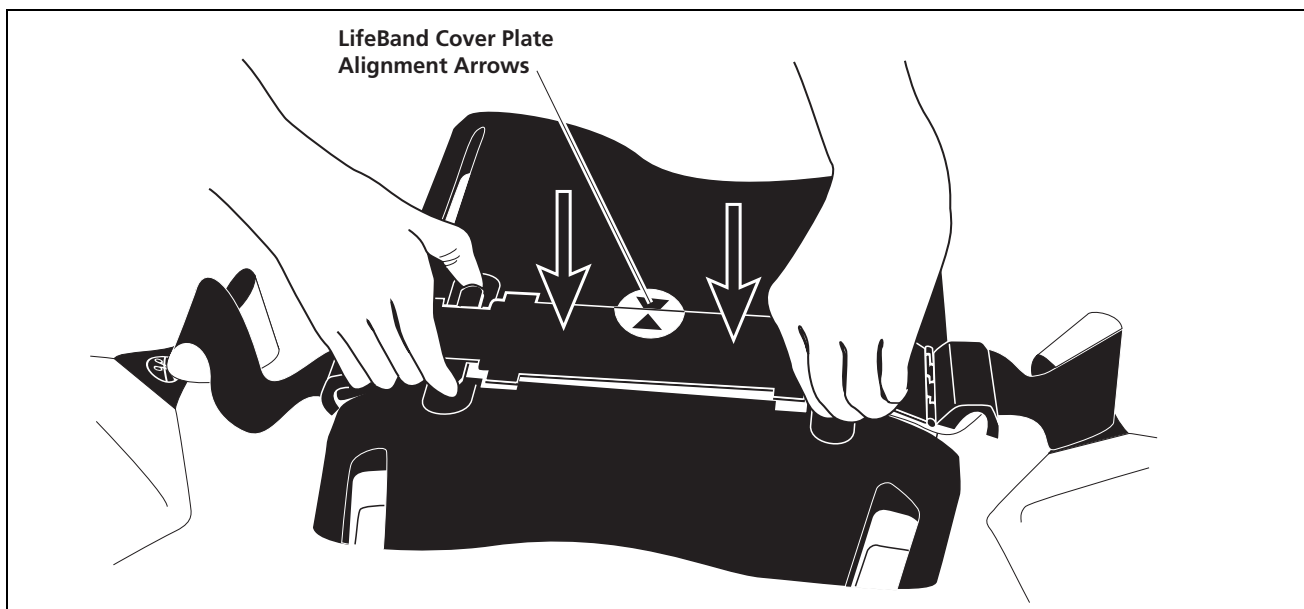

Figure 2-3 Snapping the LifeBand Cover Plate into Place

9. Flip down and snap into place the hinged belt guards of the LifeBand cover plate to engage the LifeBand chest bands to the rollers (see Figure 2-4).

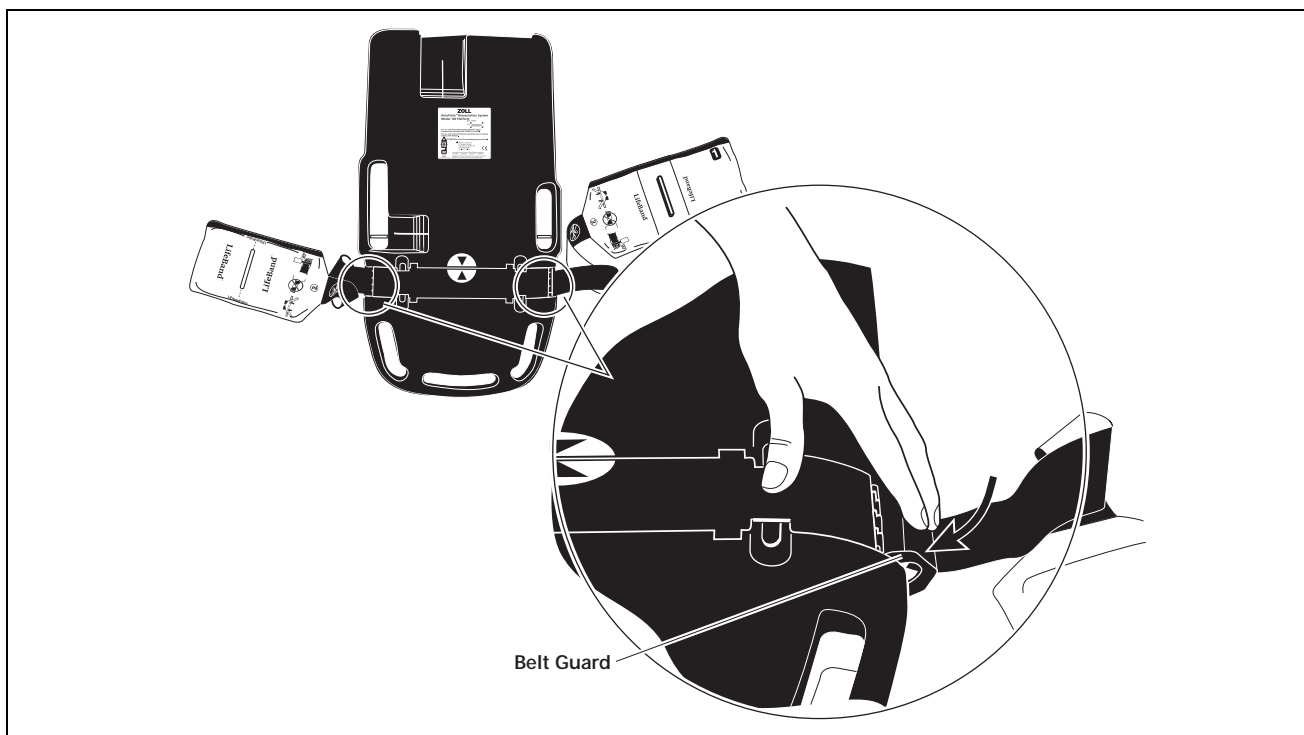

Figure 2-4 Flip Down the Hinged Belt Guards of the LifeBand

10. Turn the Platform over and press the On/Off button to power it up. If the User Control Panel reports a user advisory, check the installation of the LifeBand band clip into the slot in the driveshaft.

2.1.2 Removing the LifeBand

Note: Please do NOT cut the LifeBand before removing it from the Platform. Cutting the LifeBand may cause the Platform to report a Fault and will require specific steps to clear that Fault.

1. Place the Platform with the patient surface facing down on a smooth, flat surface.
2. Flip up the hinged belt guards of the LifeBand cover plate to disengage the LifeBand from the rollers (see Figure 2-5). You will hear the guards “snap.” This is normal.

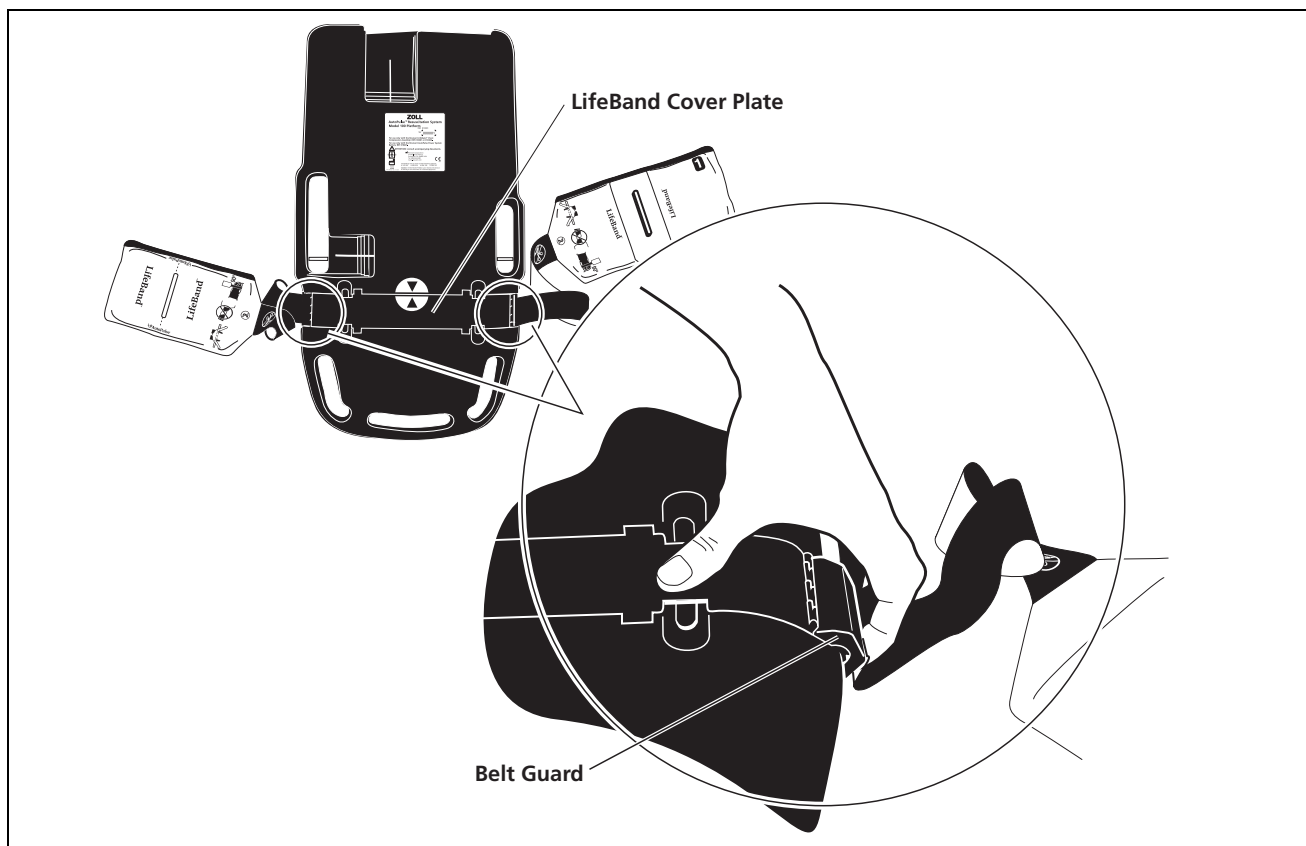

Figure 2-5 *Flip Up the Hinged Belt Guards of the LifeBand*

- Using both hands, pinch together the locking tabs of the LifeBand cover plate and firmly pull the plate straight up and away from the Platform (see Figure 2-6).

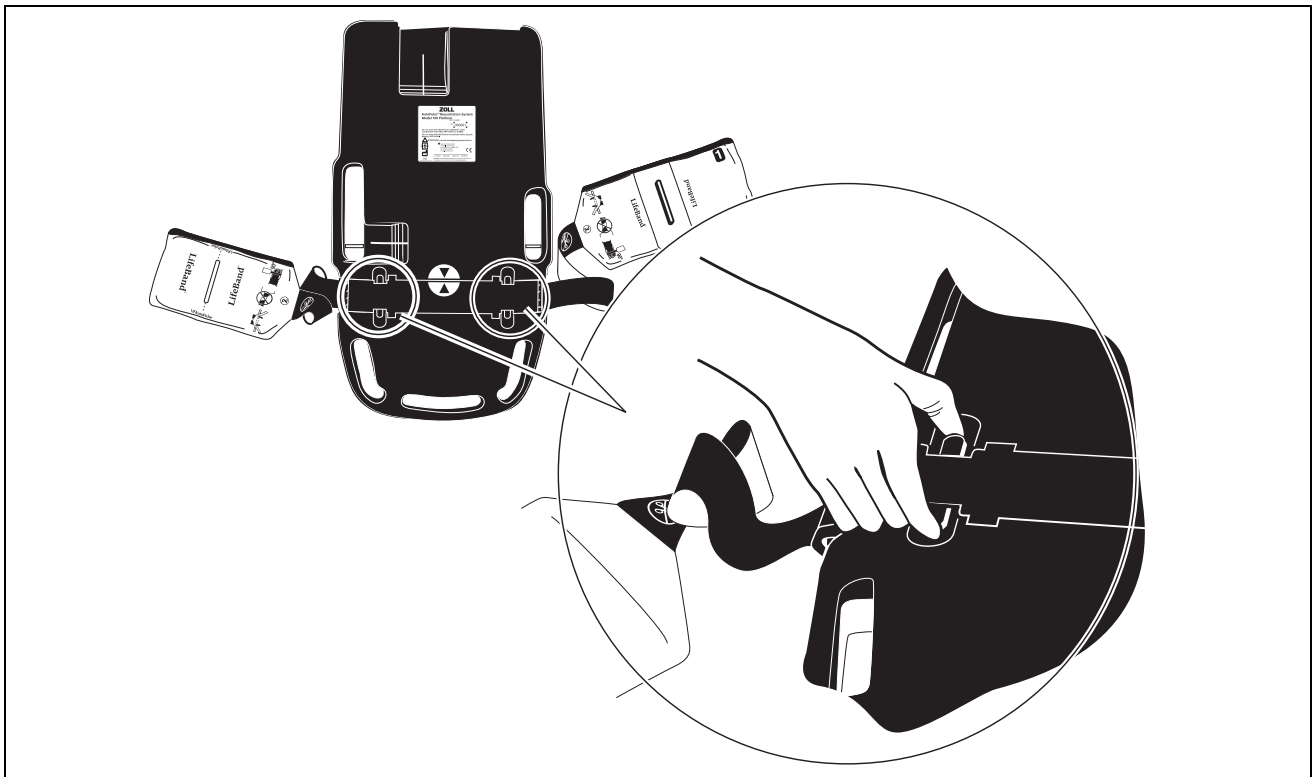

Figure 2-6 *Pinching the Locking Tabs of the LifeBand*

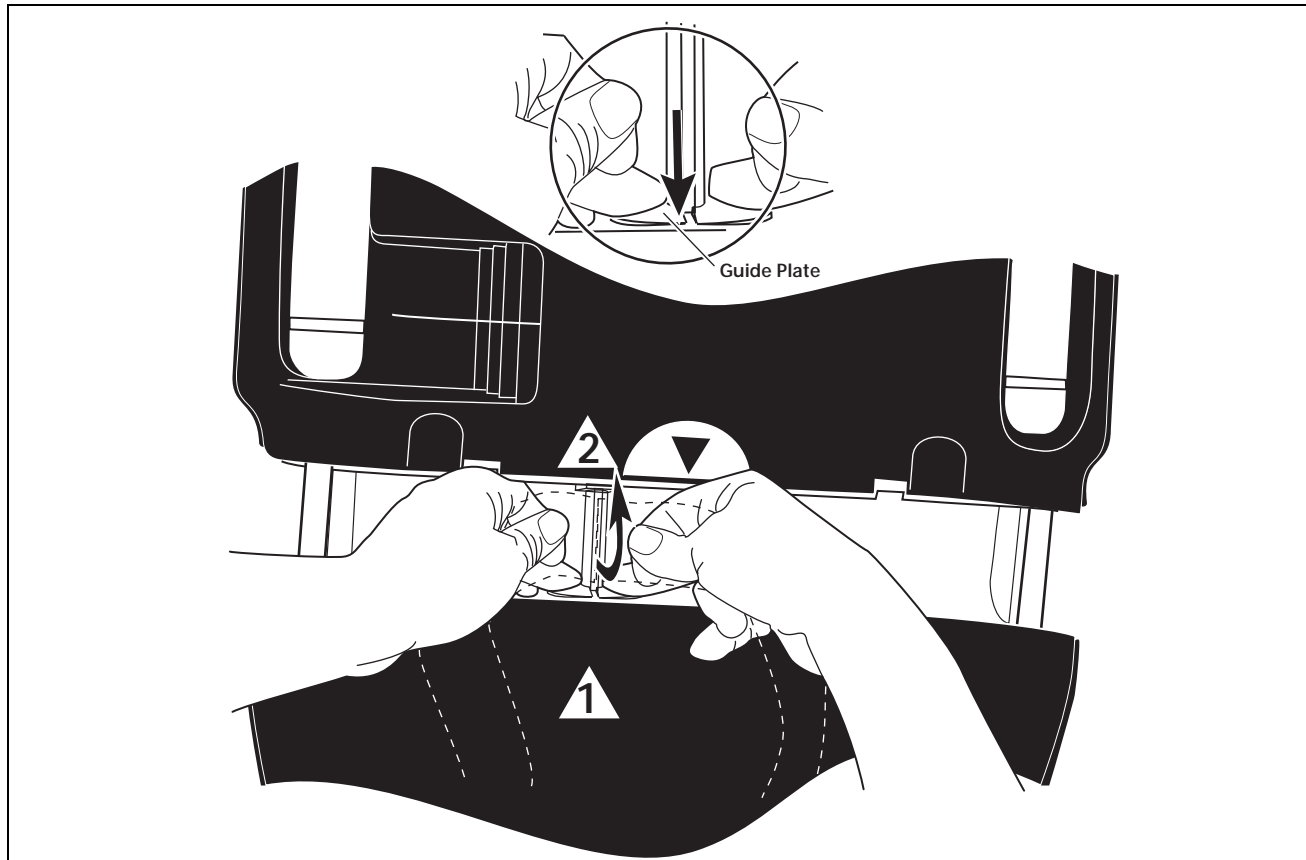

Figure 2-7 Removing the LifeBand from the Platform

Warning: Removing the band clip when the driveshaft is not at its *home* position (see Figure 2-10) will result in a permanent User Advisory (45) that the user will not be able to clear. This may be the case if the LifeBand has been cut. Please refer to Section 2.1.2.1, “Removing a LifeBand that is Cut or Not in the Home Position” for additional specific instructions before removing it. Do not continue to remove the LifeBand using the following procedure without first consulting Section 2.1.2.1.

4. Remove the LifeBand from the Platform by grasping the LifeBand chest band with the thumb and index finger of both hands, on either side of the LifeBand band clip. **1** Push in the guide plate, using both middle fingers. Keeping the guide plate pushed in, **2** pull up the band to remove the clip from the shaft (see Figure 2-7).
5. **Discard the LifeBand as it is a single-use component after patient use. Treat the LifeBand as contaminated medical waste and dispose of it accordingly. There are no user-serviceable parts.**

6. Inspect the new, replacement LifeBand for cuts or tears.
7. Install the new LifeBand following the procedures in Section 2.1.1, “Installing the LifeBand”.

2.1.2.1 Removing a LifeBand that is Cut or Not in the Home Position

The chest band must be completely unwound from the driveshaft before it is removed. When the chest band is completely unwound the seam is visible and the driveshaft rests in the Home Position (see Figure 2-10). Until a LifeBand is installed, a shaft lock mechanism secures the driveshaft in the Home Position: do not attempt to defeat the shaft lock mechanism.

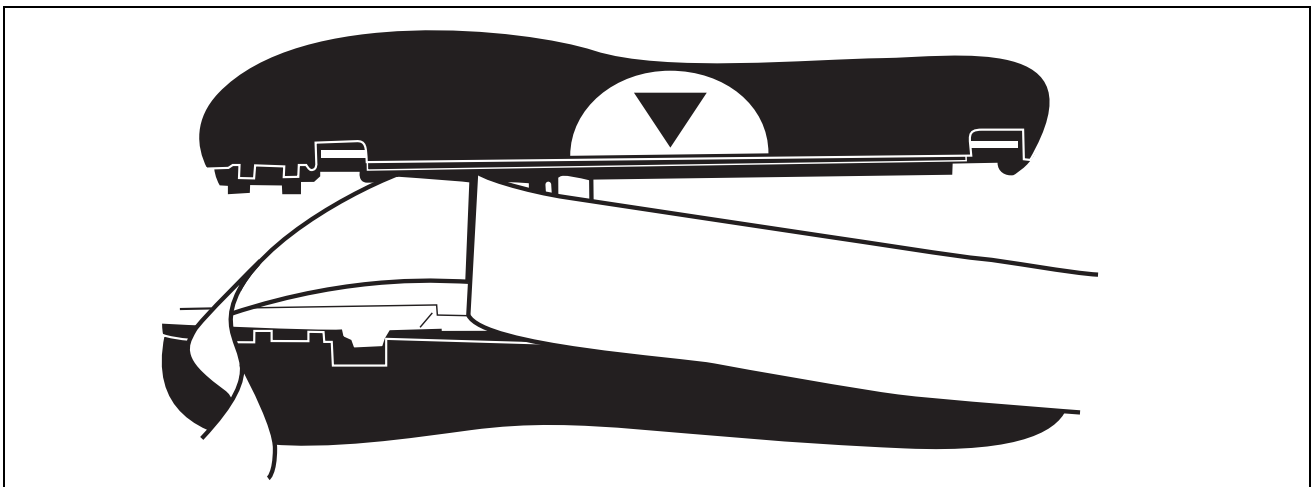

Figure 2-8 *LifeBand NOT in the Home Position: Do Not Remove!*

Removing the band clip when the driveshaft is not at its home position will result in a permanent User Advisory (45) that the user will not be able to clear. The LifeBand should be removed from the driveshaft **ONLY** from its home position.

If the chest bands have been cut it is quite possible that the chest band is still wound onto the driveshaft. Care should be taken to ensure that the bands are fully extended before the cover plate is opened and the band clip is removed.

If the chest band is not completely unwound from the driveshaft follow this procedure:

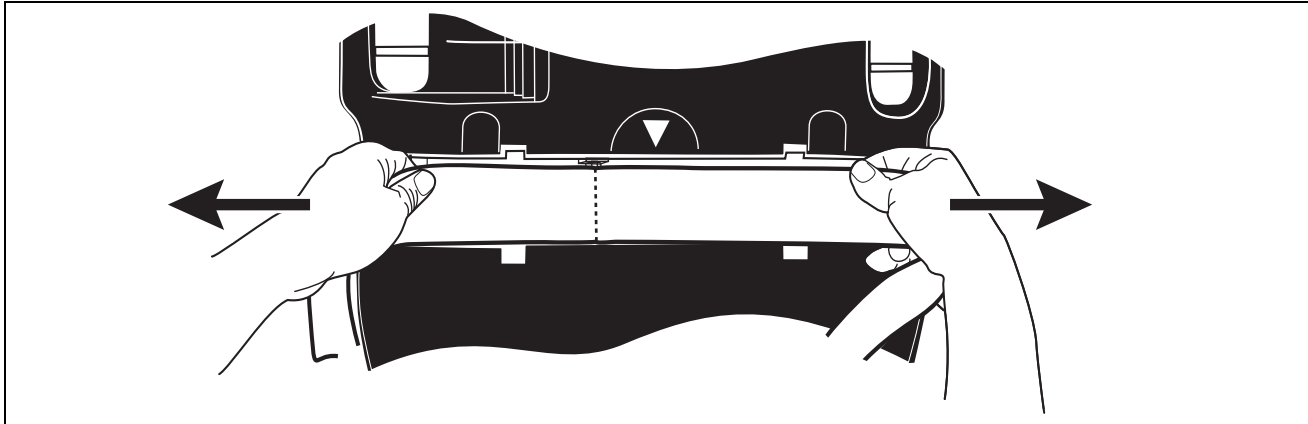

Figure 2-9 *Positioning the LifeBand for Removal*

1. Once the cover plate is removed, take hold of the chest band on either side of the driveshaft and pull both bands outward.

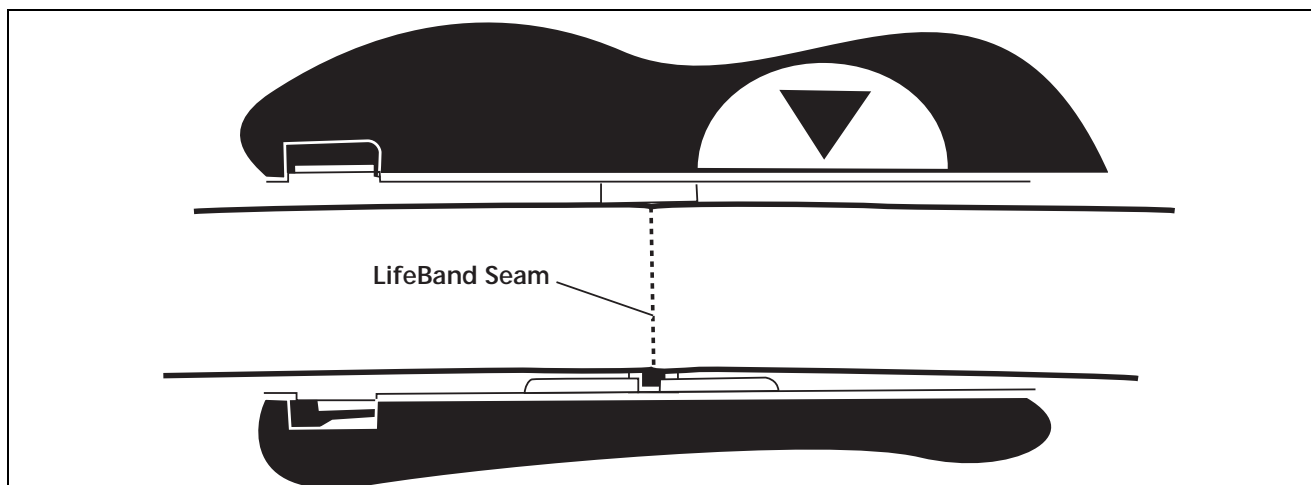

Figure 2-10 *LifeBand in the Home Position: Ready for Removal*

2. The chest bands should now be fully extended. The seam securing the band clip should easily be seen and the driveshaft is centered. The LifeBand may now be removed continuing with the procedure in Section 2.1.2 on page 2-6. Do not remove the LifeBand if it is not in this position.

2.2 Battery Installation and Removal

Remove a charged Battery from the Battery Charger. Ensure the Battery is fully charged before insertion into the Platform (refer to the *AutoPulse Power System User Guide* for more information). Replace the Battery remaining in the Platform with one that is fully charged.

2.2.1 AutoPulse Li-Ion Battery Installation and Removal

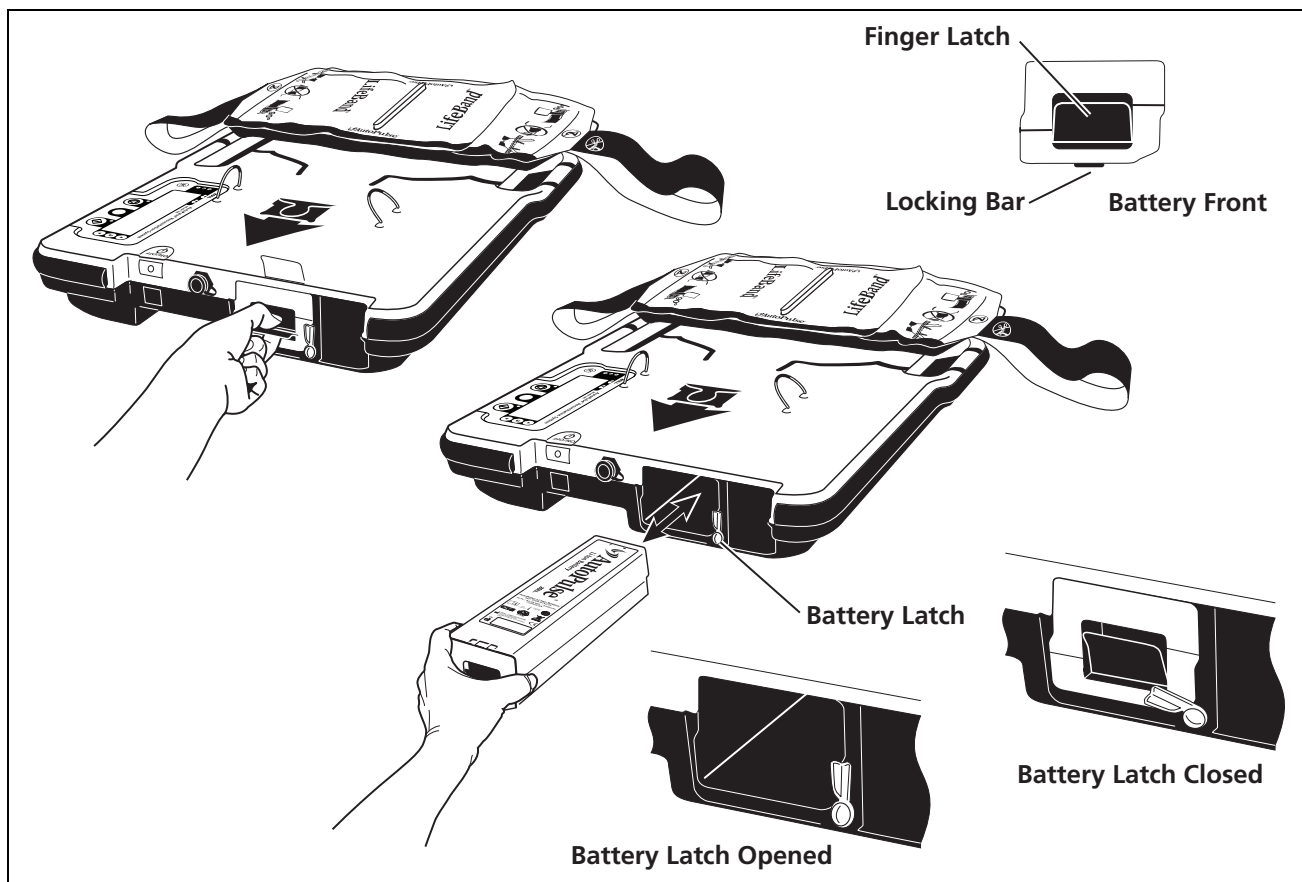

Figure 2-11 AutoPulse Li-Ion Battery Installation and Removal

To install the Li-Ion Battery, first make sure the Battery Latch is rotated out of the way so that the Li-Ion Battery can slide into the Battery compartment (see Figure 2-11). Then slide the Li-Ion Battery into the Battery compartment in the Platform. The Li-Ion Battery should snap into place and mount flush with the Platform. The Finger Latch for the Li-Ion Battery should also be flush with the Platform such that the red strip on the inside of the Finger Latch is not visible. Then rotate the Battery Latch into position as needed.

The Li-Ion Battery is mechanically keyed so that it can only be inserted in one orientation. If resistance is met, check for appropriate orientation, and check to ensure there are no obstructions to battery insertion and that the Battery Latch is open.

Ensure that the Li-Ion Battery is securely latched (snaps into place) before moving the Platform or initiating chest compression. Power on the Platform every time the Li-Ion Battery is installed to ensure it is properly seated and providing power to the Platform.

To remove the Li-Ion Battery, first rotate the Battery Latch into the open position as shown in Figure 2-11. Then hold the Platform firmly and pull the Finger Latch away from the Platform. This will disengage the Locking Bar and allow the Li-Ion Battery to be pulled straight out until it fully clears the Battery compartment.

Caution: Only use ZOLL Batteries specifically designed for use with the Platform. The use of other batteries may cause permanent damage to the Platform and will void the warranty.

2.3 Administrative Menu: User Pre-set Options

There are several options that may be pre-set by the user prior to deployment of the Platform. These options are:

- Compression mode
- Mute duration
- Tone volume
- Continuous Mode Ventilation Tone

Additionally the Administrative Menu allows you to access the following information (refer to section Section 3.7, “Viewing Platform Information,” on page 3-18):

- The last patient session
- The AutoPulse Platform
- The AutoPulse Battery

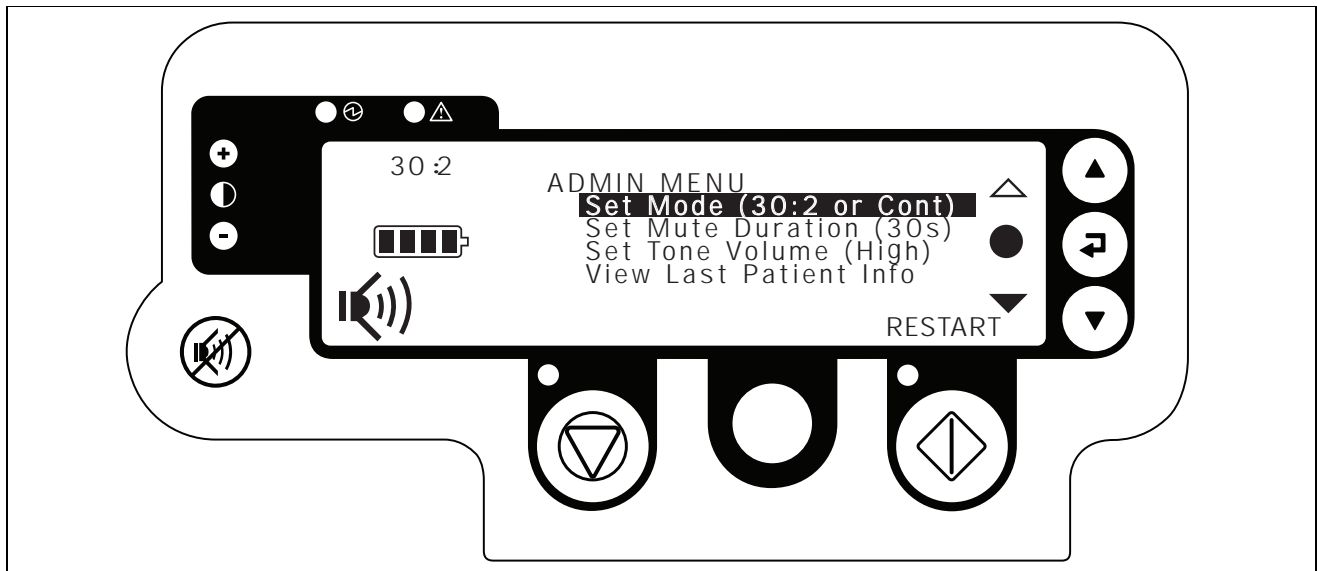

Figure 2-12 Administrative Menu

To access the Administrative Menu the Platform must be powered off. The Administrative Menu is activated by pressing the On/Off switch while both the Stop (orange) and Start (green) buttons are being depressed. Once the Administrative Menu is active use the Move Up and Down arrow buttons to highlight the desired menu item and the Select Choice Button to select it.

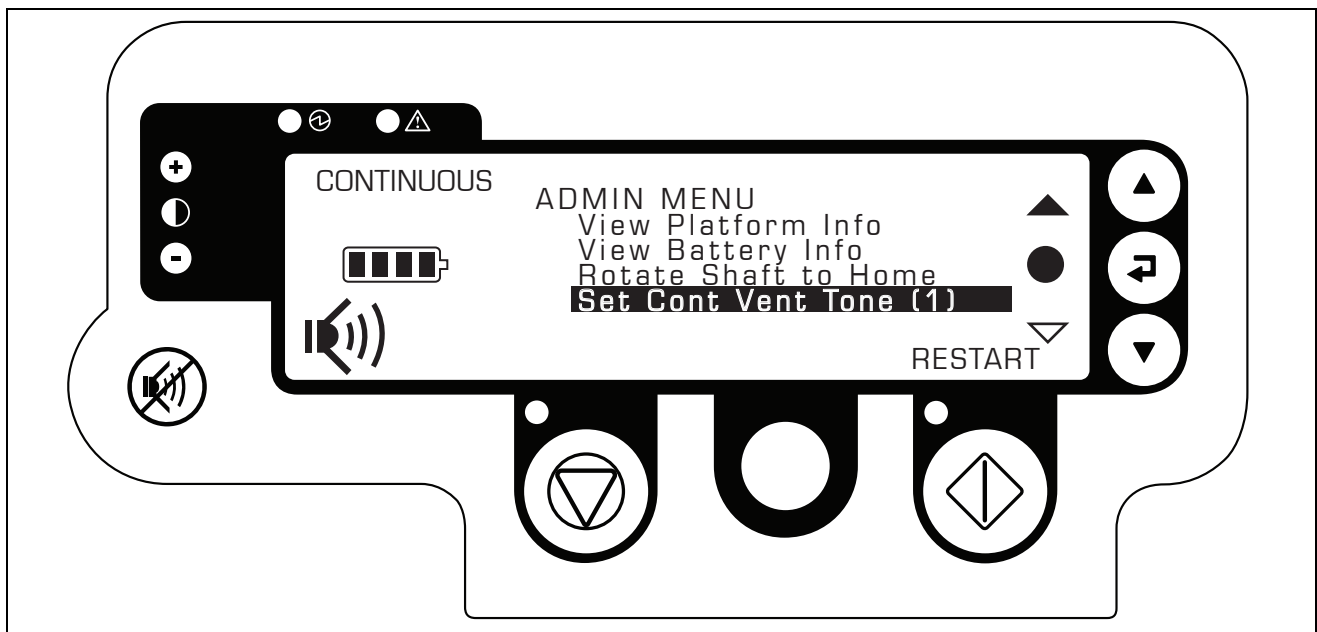

Figure 2-13 Administrative Menu (scrolled down)

To exit from the Administrative Menu, press the “START” (green) button under the word “RESTART.” The Platform will restart and place you into the idle state, ready for patient alignment or for system power-down.

Note: The current setting is displayed in the parenthesis after the main menu item.

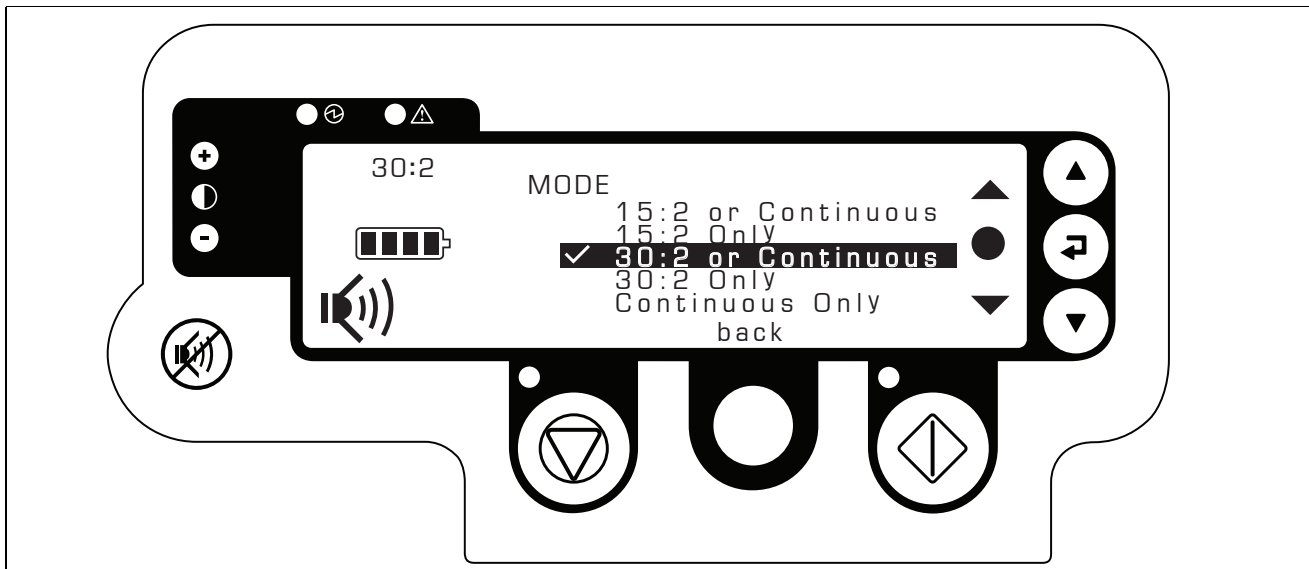

Figure 2-14 Compression Mode Menu

The “Set Mode” menu item allows you to restrict the AutoPulse Platform operation to a single compression mode or to allow on-the-fly mode switching. Selecting “30:2 or Continuous” or “15:2 or Continuous” will allow on-the-fly mode switching between 30:2 and continuous compressions or 15:2 and continuous compressions respectively, while the system is actively doing compressions. Selecting “30:2 Only” or “15:2 Only” will restrict the system operation to the 30:2 mode or 15:2 mode, respectively. Selecting “Continuous Only” will restrict the system operation to continuous compressions. Highlight the desired setting using the Move Up and Down arrow buttons, press the Select Choice Button to select it (a check will appear beside the selected item) and then press the gray Menu/Mode switch button under the word “back” to return to the main Administrative Menu.

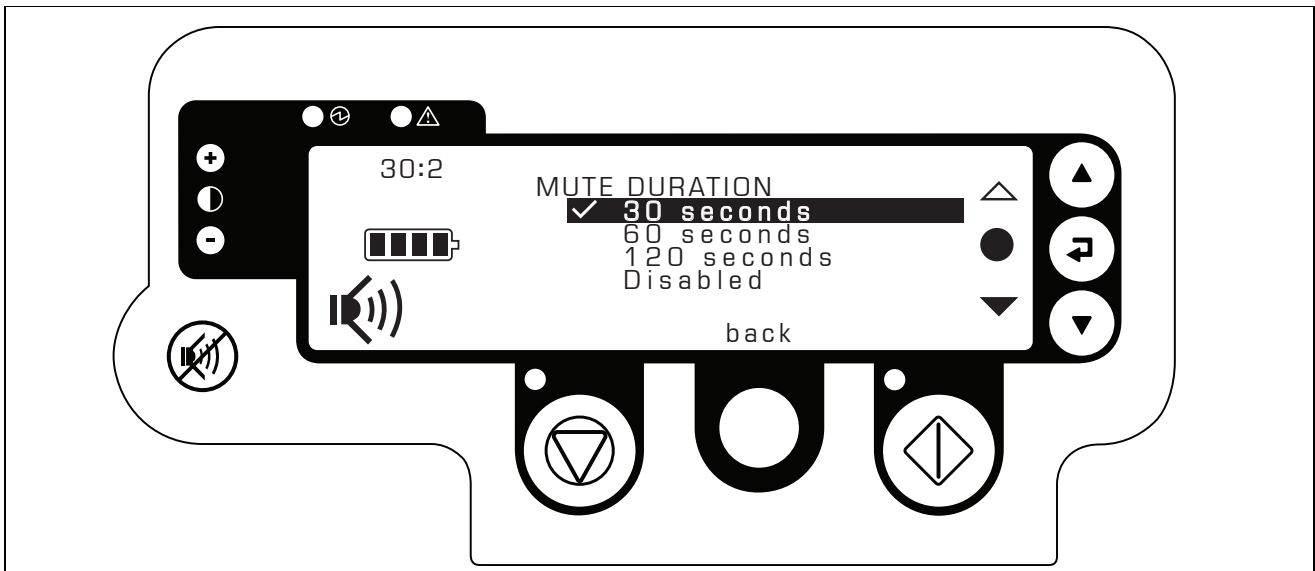

Figure 2-15 Mute Duration Menu

The “Set Mute Duration” menu item allows you to set the length of time that the audio tone mute will be sustained when it is activated by pressing the Tone Mute Button, or to disable the button’s function altogether. The time options are to set the mute to last for “30 seconds”, “60 seconds” (one minute) or “120 seconds” (two minutes). Highlight the desired setting using the Move Up and Down arrow buttons, press the Select Choice Button to select it (a check will appear beside the selected item) and then press the gray Menu/Mode switch button under the word “back” to return to the main Administrative Menu. If the pause alert tone is disabled here it cannot be re-enabled, during operation, by using the Tone Mute Button (refer to Section 1.4.2.6, “Tone Mute Button,” on page 1-7).

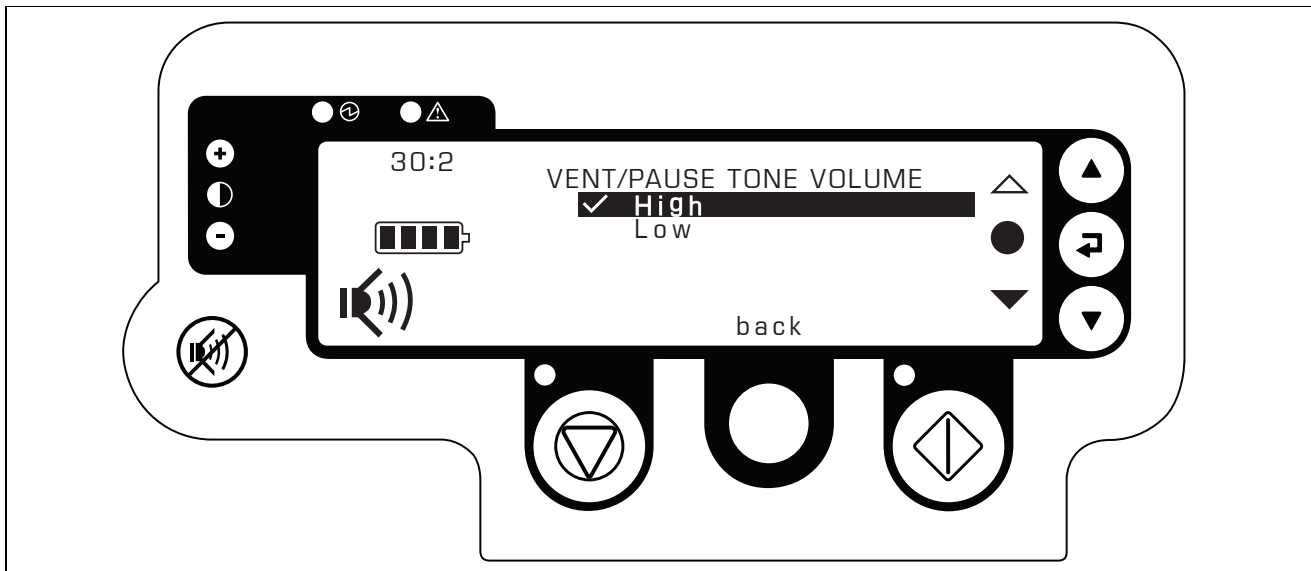

Figure 2-16 Ventilation/Pause Tone Volume Menu

The “Set Tone Volume” menu item allows you to select the volume of the audible tone sequence that is used to cue for ventilation during active compressions and to alert the operator that the system has been deliberately stopped (paused) while actively doing compressions. Choices are “High” and “Low.” Highlight the desired setting using the Move Up and Down arrow buttons, press the Select Choice Button to select it (a check will appear beside the selected item) and then press the gray Menu/Mode switch button under the word “back” to return to the main Administrative Menu.

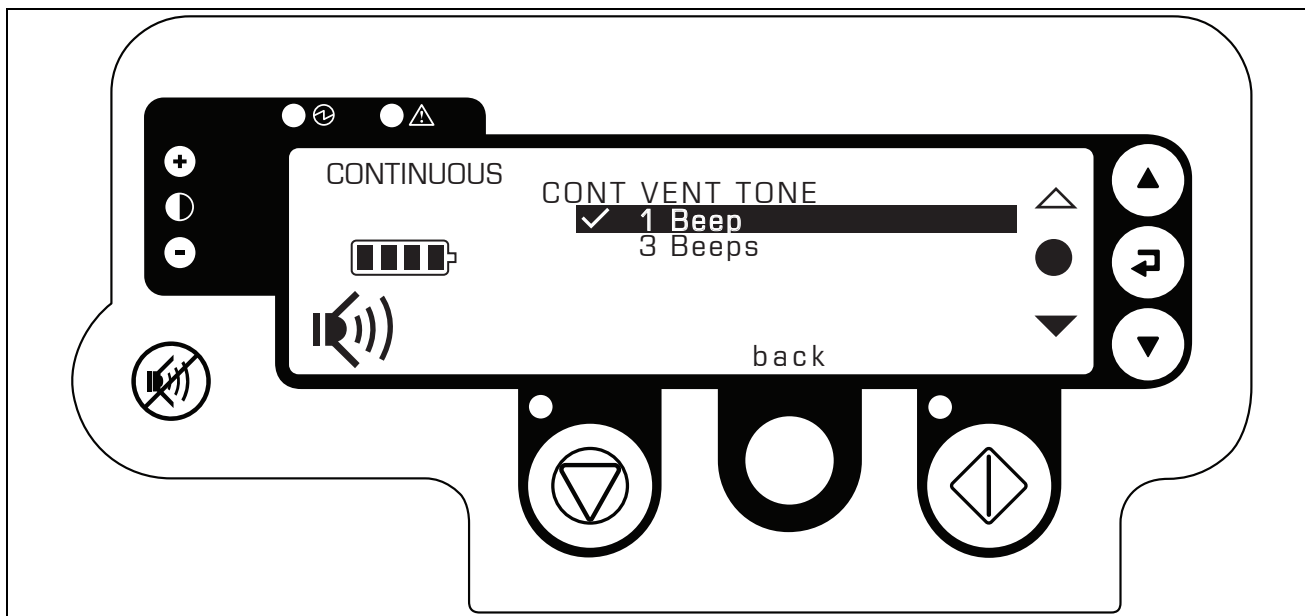

Figure 2-17 Continuous Mode Ventilation Tone Menu

The “Set Cont Vent Tone” menu item allows you to select how many ventilation tones sound when in Continuous Compression Mode. Selecting “1 Beep” (the factory pre-set) will allow for a single ventilation tone to sound in order to cue rescuers to ventilate the patient. Selecting “3 Beeps” will allow for three ventilation tones to sound as a countdown to cue the rescuer to ventilate the patient after the third ventilation tone. Highlight the desired setting using the Move Up and Down arrow buttons, press the Select Choice Button to select it (a check will appear beside the selected item- see Figure 2-17), and then press the gray Menu/Mode switch button under the word “back” to return to the main Administrative Menu.

[This page left intentionally blank.]

3 Using the AutoPulse System

This chapter describes how to use the AutoPulse System in an emergency situation. The AutoPulse User Control Panel automatically provides display prompts to guide you.

Before deploying the AutoPulse System, note the following Cautions:

Caution: Use care while using sharp instruments around the LifeBand.

Caution: Do not block the vents of the AutoPulse Platform. If airflow through the vents is obstructed, the temperature of the Patient Surface (Figure 1-2) of the AutoPulse platform may rise. If the temperature of the Patient Surface exceeds 45°C for more than five minutes, the Platform will cease compressions and advise the user to check the vents.

3.1 Deploying the AutoPulse System

In order to deploy the AutoPulse System quickly and with the least interruption in cardiac compressions, a *pit crew* model - similar to that which is used in auto racing - is suggested for roles and positions of the staff involved in performing defibrillation and using the AutoPulse System. Your local ZOLL representative can provide you with appropriate detailed instructions based upon the setting in which you work (EMS or hospital) and the number of clinicians that are typically involved in dealing with sudden cardiac arrest. Each organization should determine how this type of model can be integrated into the typical roles performed by members of their resuscitation team. Practice as a team using this model will help to streamline actions and ensure rapid, efficient deployment.

1. Power up the Platform. The On/Off button is located on the top (“head”) edge of the Platform (see Figure 3-1).

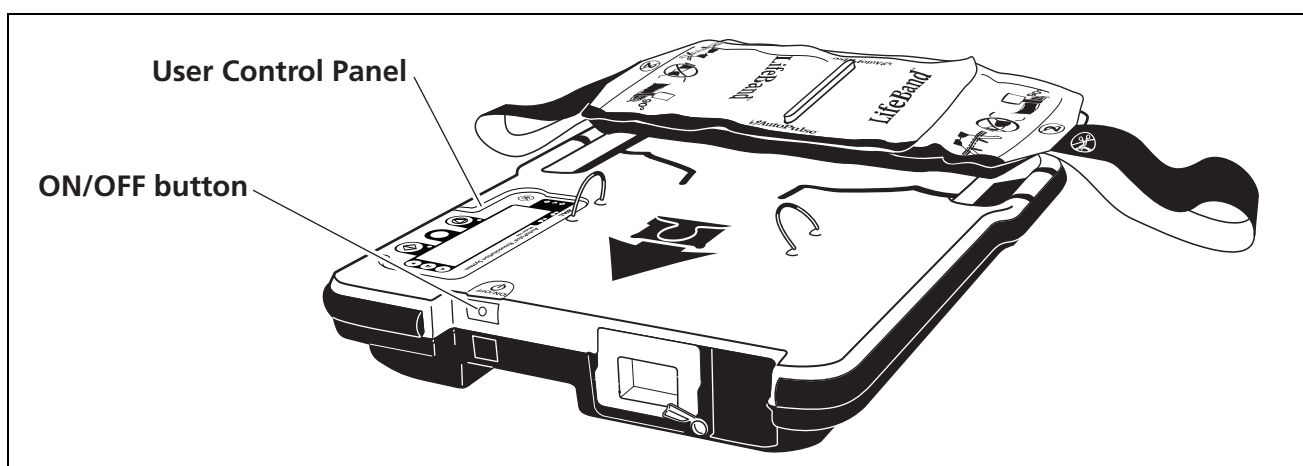

Figure 3-1 On/Off Button Location

2. The Platform illuminates the green Power light-emitting diode (LED) on the User Control Panel and performs its self-tests (see Figure 3-2). Refer to the User Control Panel and its display panel during the operation of the Platform. All operating information is available on the User Control Panel.

Note: Make sure that no User Advisory, Fault or System Error messages display.

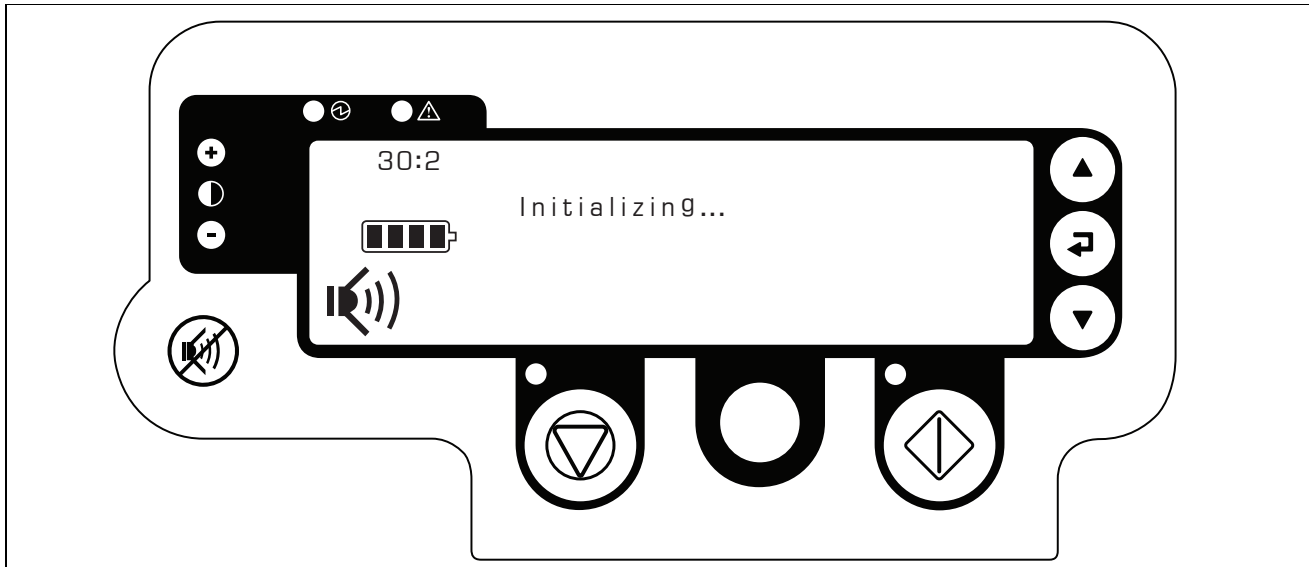

Figure 3-2 Self-Test Display Panel Screen

3. The Platform indicates that it is ready for use (see Figure 3-3).

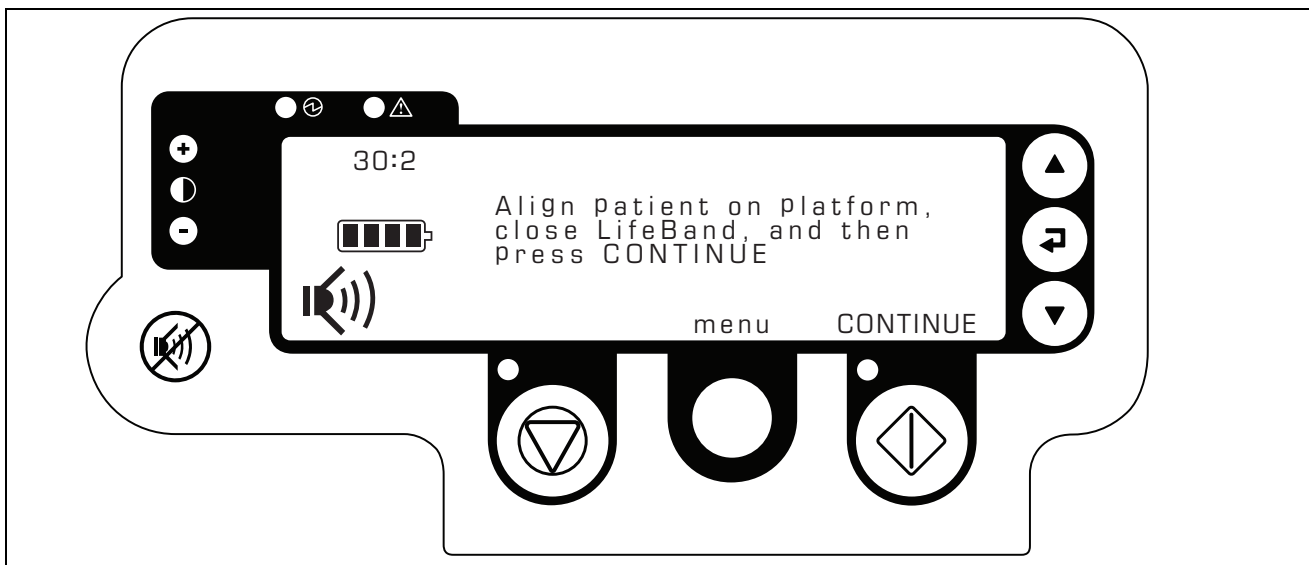

Figure 3-3 Patient-Readiness Display Panel Screen

4. After assessing the patient's condition, sit the patient up and make a single cut down the back of the patient's clothing (see Figure 3-4), or undo any ties on the back of the gown in a hospital. The posterior defibrillation/pacing pad may be placed on the patient's back at this time if the local protocol calls for anterior-posterior placement. Use of standard pads in both the a-p or anterior-anterior/apex-sternum placement is acceptable and will not affect the operation of the Platform or defibrillator.
5. Slide the Platform into position behind the sitting patient and lay the patient down onto the Platform. Placing the Platform to the patient's side and "log rolling" him or her onto the Platform is an acceptable alternative.

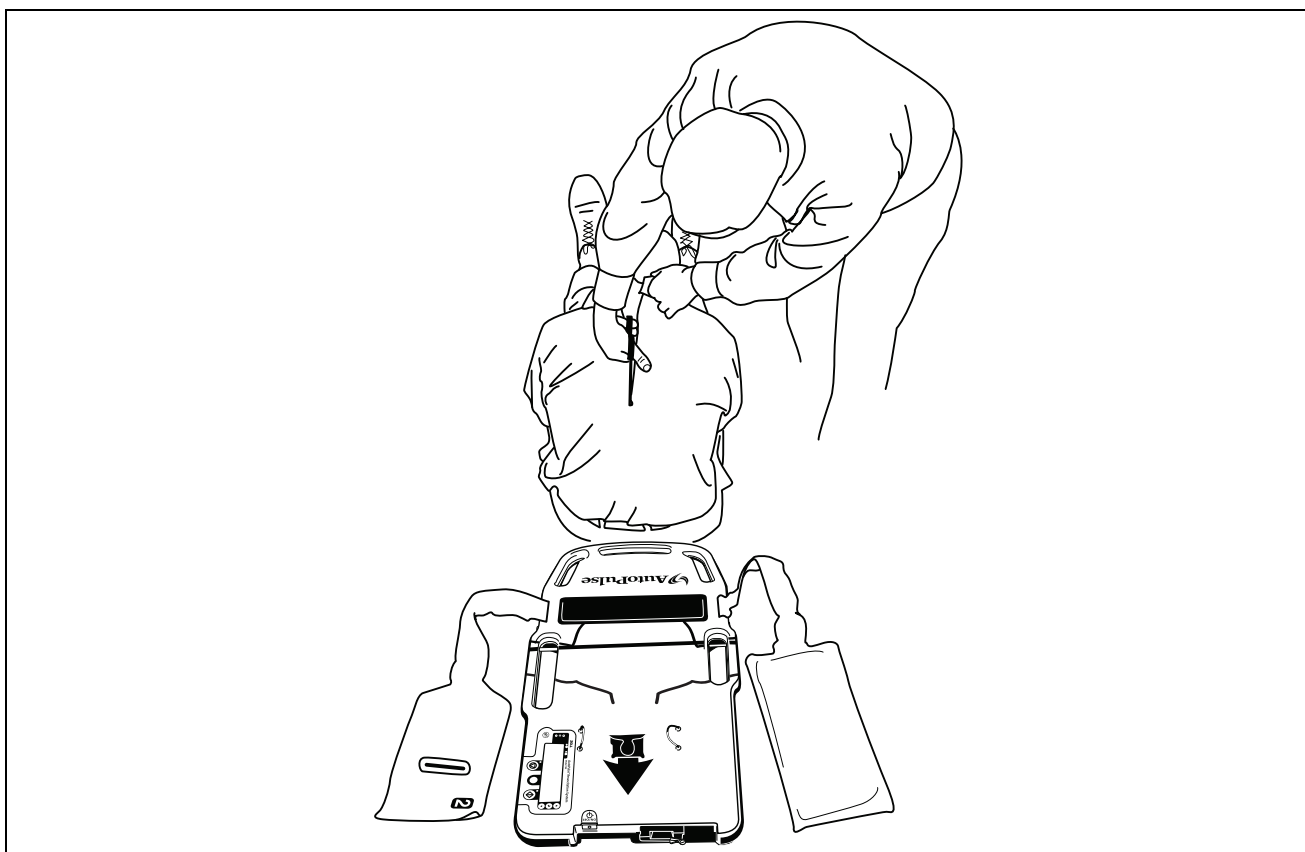

Figure 3-4 *Cutting Patient Clothing and Positioning of AutoPulse*

6. Grasp the clothing by the sleeves and pull down toward the ankles to remove all of the clothing from both the front and back of the torso (see Figure 3-5). The anterior pad(s) may be placed at this time.



Figure 3-5 Removal of all Clothing from the Torso

7. Position the patient so that he/she is centered laterally (from left to right) and that the armpits are aligned with the Platform using the yellow line positioning guides on the platform as shown in Figure 3-6.

Warning: Do not place or position the patient on the Platform in either a facedown orientation or on the patient's side. Also ensure the head orientation is correct. The head label arrow points towards the patient's head.

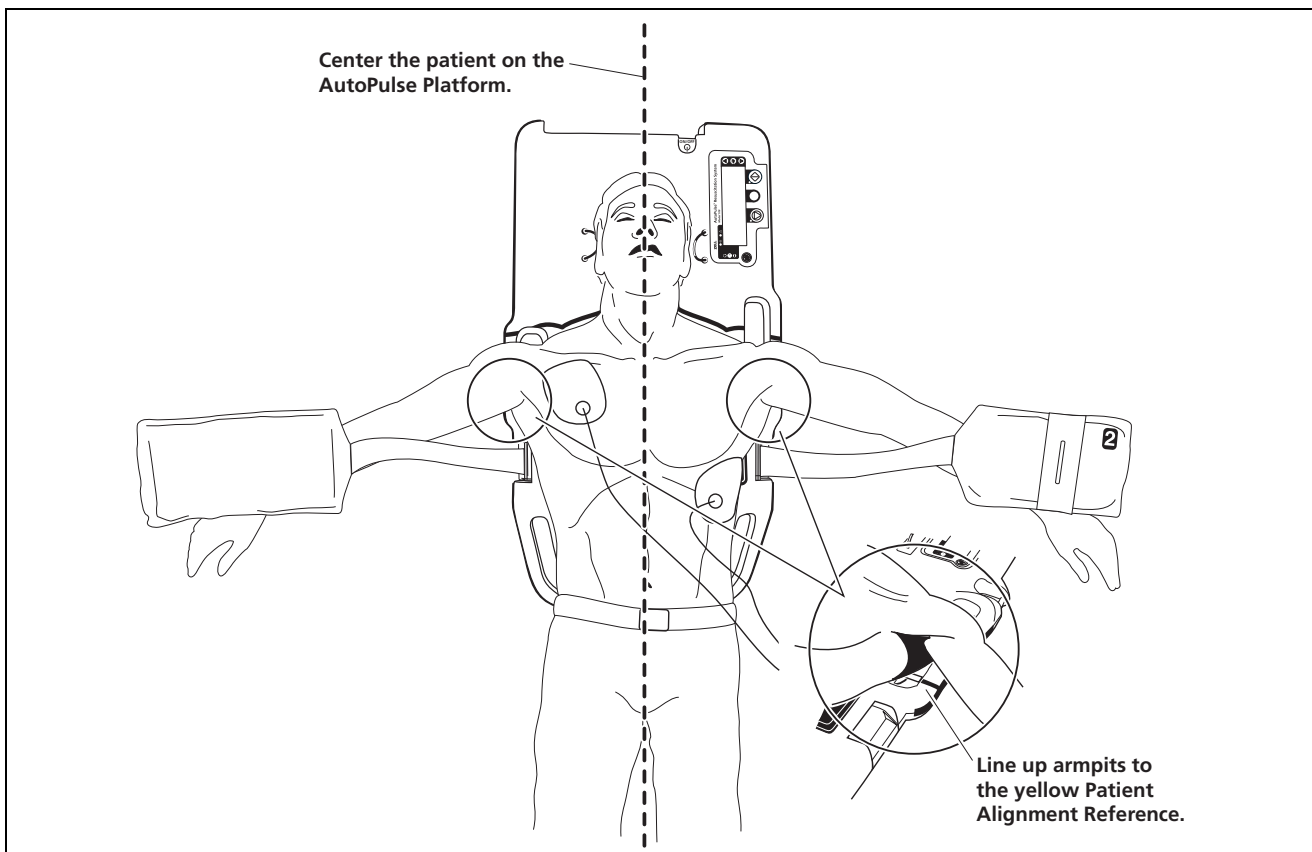

Figure 3-6 Correct Patient Alignment

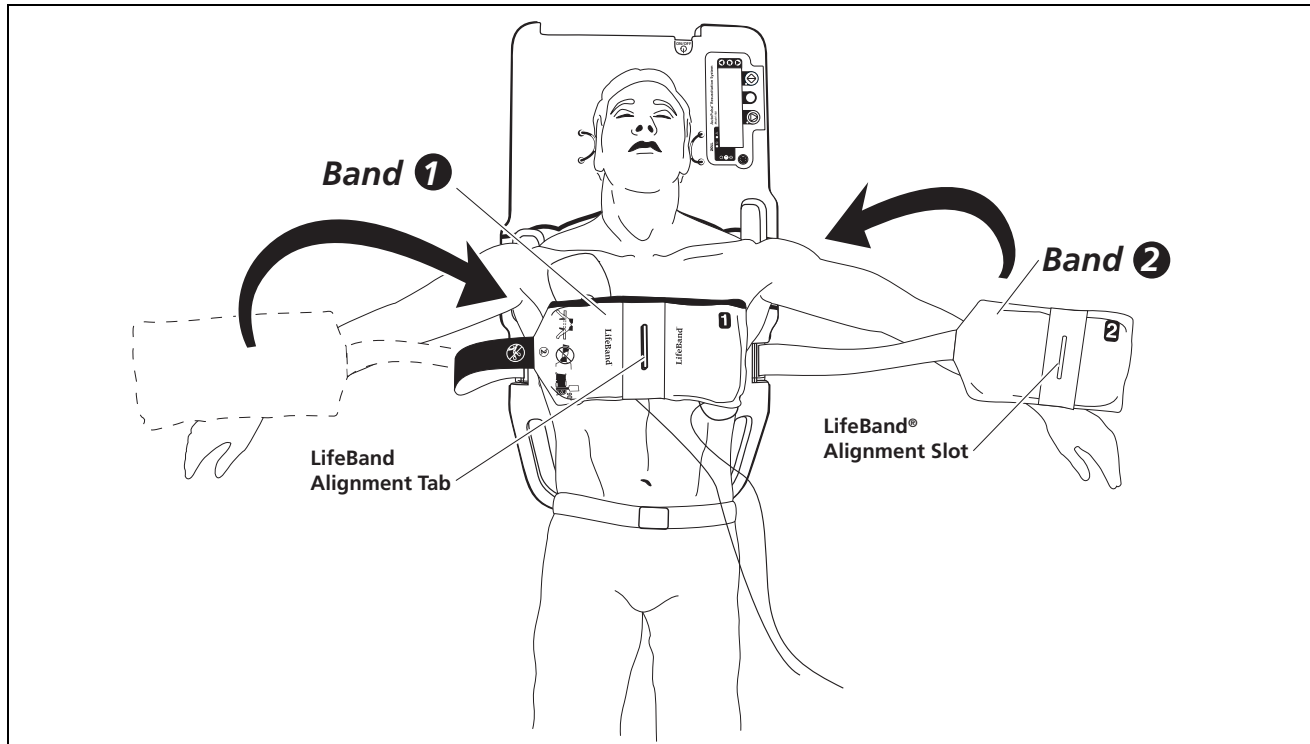

Figure 3-7 *Aligning the LifeBand*

8. Close the LifeBand around the patient's chest.

Caution: Make sure that the LifeBand is not twisted before automatic compressions begin.

Note: AED or defibrillation pads are *not* components of the LifeBand.

To properly align the two sides of the LifeBand:

- a) Place band 1 on top of patient's chest (see Figure 3-7).
- b) Locate mating slot of band 2 over the alignment tab 1 (see Figure 3-7).
- c) Press the bands together to engage and secure the Velcro® fastener (see Figure 3-8).
- d) Lift up the LifeBand to its fullest extension, ensuring that the side bands are at a 90 degree angle to the platform, that they are not twisted and that there are no obstructions.
- e) Center the LifeBand on the patient's chest, placing it such that its center is over the area upon which manual compressions are conducted.

Note: If the bands cannot be closed, use manual CPR.

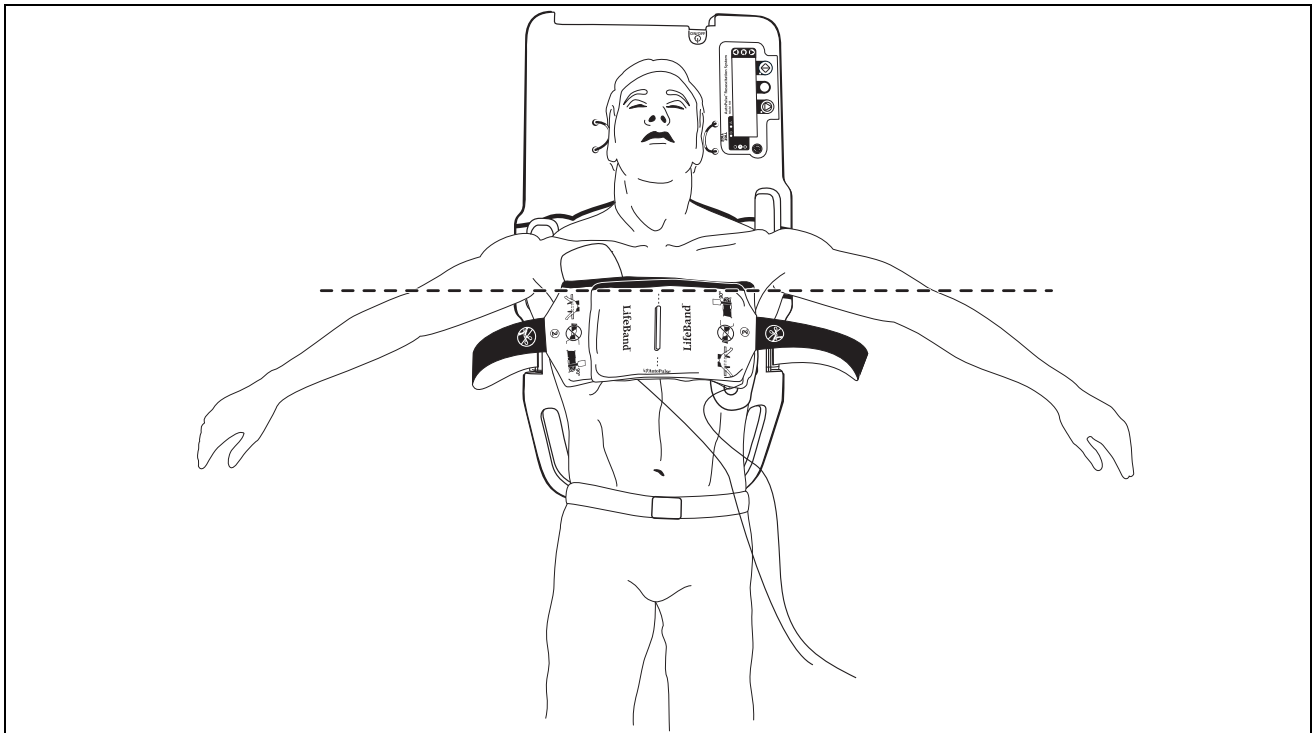

Figure 3-8 *Fastening the LifeBand*

3.2 Starting Chest Compressions

1. Make sure that the yellow upper edge of the LifeBand is aligned with the patient's armpits, and is directly over the yellow line on the Platform. Also make sure that there are no obstructions, such as clothing, straps or equipment, with the bands.

Warning:

- Failure to properly position the LifeBand at the patient's armpit line may cause injury to the patient.
- Failure to properly position a patient, both vertically and laterally with respect to the Platform, may cause injury to the patient.
- Do not strap across, or otherwise constrain, the LifeBand. Constraining the movement of the bands can damage or break the LifeBand.

- Press and release the Start/Continue button once. The Platform automatically adjusts the bands to the patient's chest (see Figure 3-9).

Warning: Do not touch the patient or the LifeBand while the Platform is analyzing the patient's size.

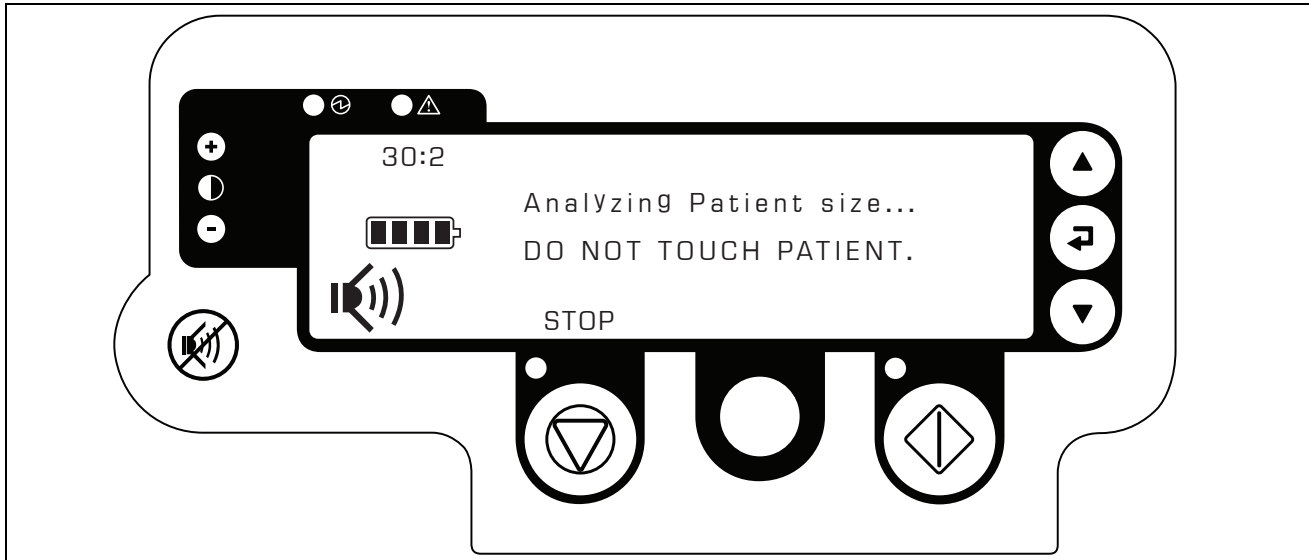

Figure 3-9 Analyzing Patient Size Display Panel Screen

- The Platform will pause for 3 seconds to allow you to verify that the patient is properly aligned and that the LifeBand has taken up any slack in the bands (see Figure 3-10).

If the patient is not properly aligned, press the Stop/Cancel button, realign the patient, and begin compressions again with step 1 on page 3-7.

Warning: If the Stop/Cancel button is not pressed within 3 seconds, compressions will automatically begin. Press the Stop/Cancel button to immediately stop the compressions.

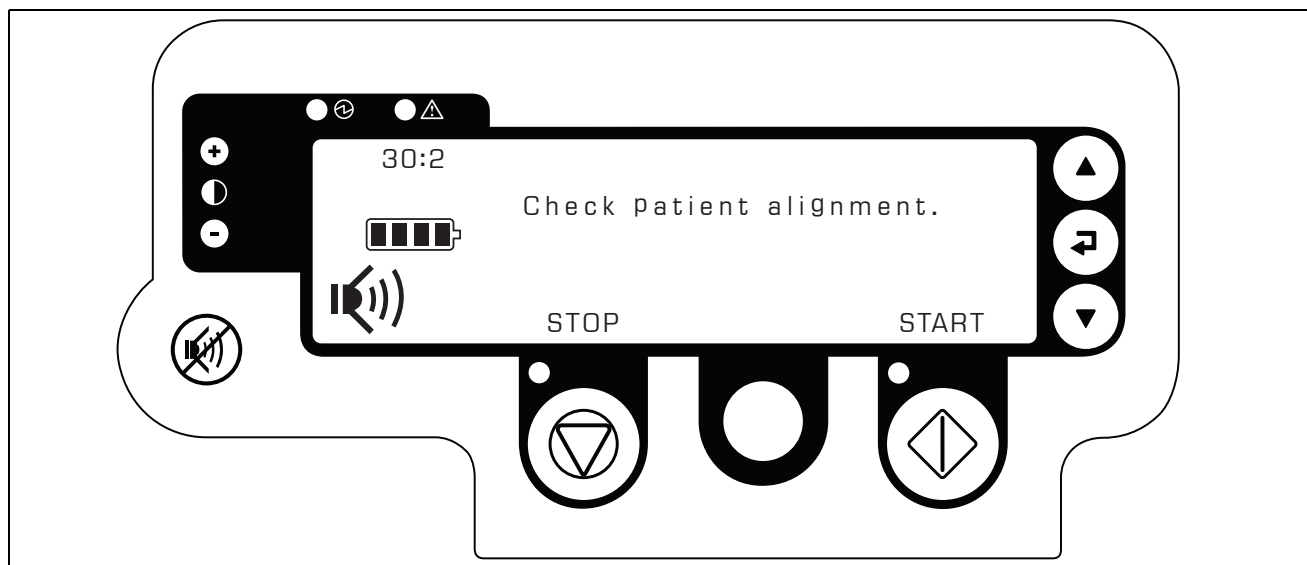

Figure 3-10 Verifying Patient Alignment Display Panel Screen

4. After the 3 second verify patient alignment pause is complete, compressions will automatically begin. You may press the Start/Continue button to immediately initiate compressions ahead of that time.

Warning:

- Do not lean on the patient after pressing the Start/Continue button.
- If you must move or realign the patient, you must press the Stop/Cancel button before adjustment.
- Do not place your hands or any other objects on or under the LifeBand while the Platform is analyzing the patient or during active operation.

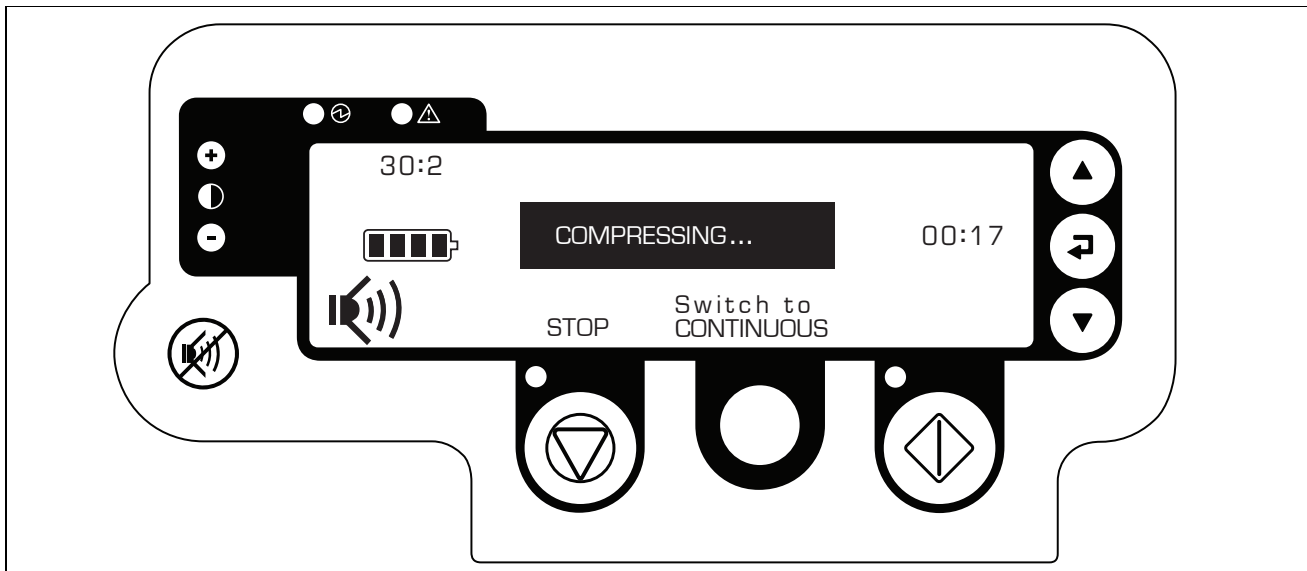

Figure 3-11 Chest Compression Display Panel Screen

5. Depending on the Mode setting in Administrative Menu (refer to section Section 2.3, “Administrative Menu: User Pre-set Options,” on page 2-10), the Platform will perform 30:2, 15:2 or Continuous compressions. In 30:2 mode it performs 30 compressions and then pauses for three seconds to permit the user to ventilate the patient before automatically resuming compressions (see Figure 3-12). In 15:2 mode it performs 15 compressions and then pauses for three seconds to permit the user to ventilate the patient before automatically resuming compressions (see Figure 3-12). In Continuous mode it performs continuous compressions. If 30:2 on-the-fly mode switching has been enabled (in the Mode setting within the Administrative Menu) then the Platform will perform in the mode (either 30:2 or Continuous) that was used last until powered down; on power up 30:2 will be the initial selection. If 15:2 on-the-fly mode switching has been enabled (in the Mode setting within the Administrative Menu) then the Platform will perform in the mode (either 15:2 or Continuous) that was used last until powered down; on power up 15:2 will be the initial selection.

In 30:2 mode three audio cue tones will sound prior to the ventilation pause: one during each of the 28th, 29th, and 30th compressions. In 15:2 mode the three audio cue tones will sound prior to the ventilation pause during each of the 13th, 14th, and 15th compressions. In Continuous mode, an audio cue tone for ventilation will sound 8 times per minute. The tones can be temporarily disabled (and re-enabled) by pressing the Tone Mute Button (refer to Section 1.4.2.6, “Tone Mute Button,” on page 1-7).

At the initiation of compressions, the counter at the right center of the display panel screen will be set to 00:00 and will automatically begin recording the elapsed time until the Stop/Cancel button is pressed. The format of the counter is minutes:seconds. When the Stop/Cancel button is pressed, the counter will immediately reset to zero and begin recording the elapsed “no-flow” time. The counter will reset to zero when chest compressions are started again.

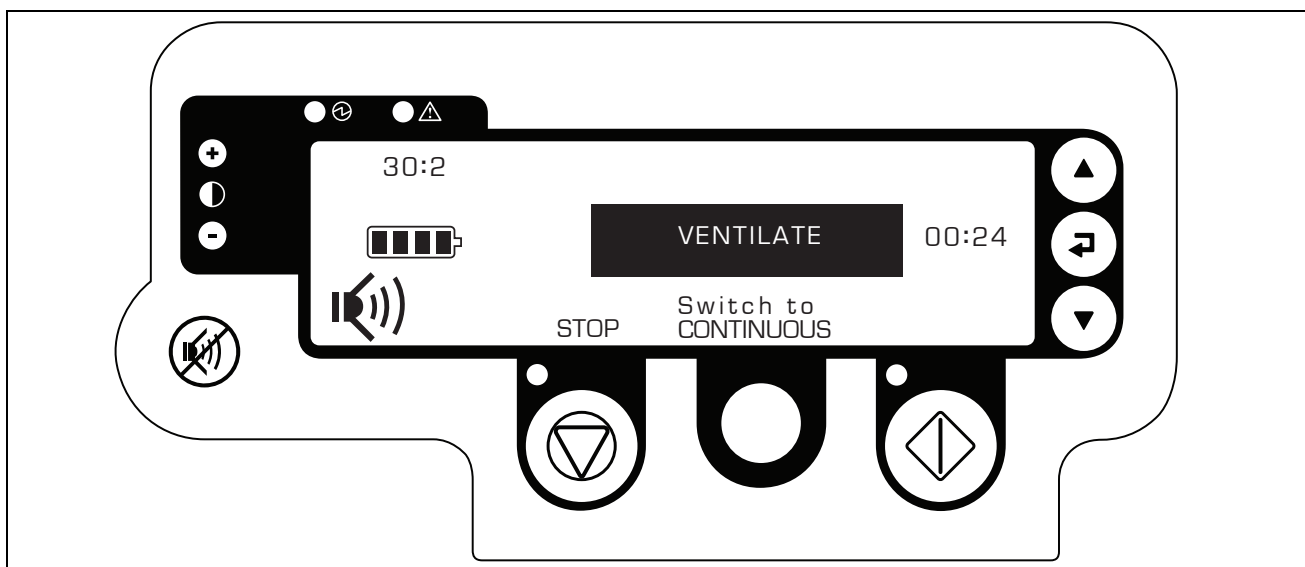

Figure 3-12 Ventilation Pause Display Panel Screen

Note: Positive pressure ventilation can be performed synchronously with any decompression and/or during the ventilation pause.

Warning:

- Check the patient's chest rise during ventilation during active operation.

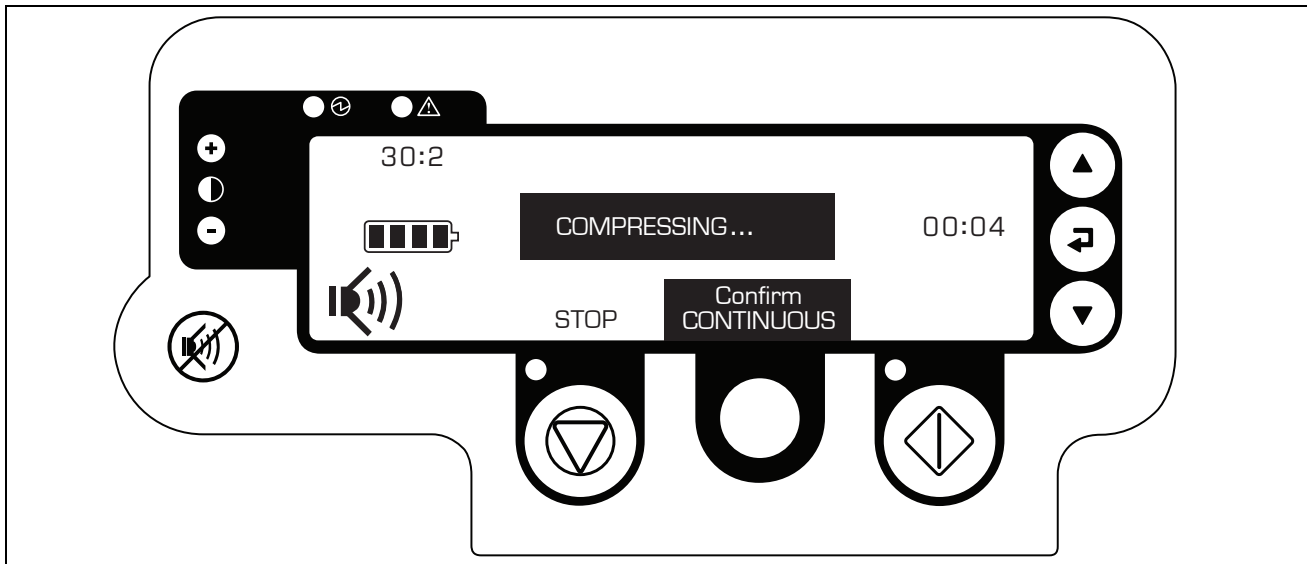

Figure 3-13 Mode Change Confirm Display Panel Screen

6. If 30:2 *on-the-fly* mode switching has been enabled you may press the gray Menu/Mode switch button to switch between 30:2 and continuous compressions. If 15:2 *on-the-fly* mode switching has been enabled you may press the gray Menu/Mode switch button to switch between 15:2 and continuous compressions. The current mode is displayed in the upper left corner of the screen. The words above the gray Menu/Mode switch button indicate the alternate mode that the Platform will switch to. If there are no words above the gray button then *on-the-fly* mode switching is not enabled, and the device will only operate in the current mode and pressing the gray button will have no effect.

Once the gray Menu/Mode switch button has been pressed you will be asked to confirm the mode switch (see Figure 3-13) by pressing the gray Menu/Mode switch button twice in rapid succession. A single tone will sound to confirm that the mode change has been accepted.

7. To access the patient or to pause the Platform for any reason, press the Stop/Cancel button. The Platform releases the tension on the LifeBand, allowing the user to pull the bands to the maximum extended position. 10 seconds after the Stop/Cancel button has been pressed a single audio alert tone will sound. Three audio alert tones will sound 20 seconds after the pause was initiated. Audio alert tones will sound continuously after 30 seconds into the pause. The tones can be temporarily disabled (and re-enabled) by pressing the Tone Mute button (refer to section Section 1.4.2.6, “Tone Mute Button,” on page 1-7) if this function is allowed in the Administrative Menu. Pressing the Stop/Cancel button while paused will exit the paused state and the alert tone will be stopped.

Note: Opening the bands during active operation will cause the Platform to stop operation immediately. To restart compressions, re-fasten the Velcro® fastener, clear the Fault by pulling up on the LifeBand and pressing Start/Continue and then follow the normal operating steps beginning with step 1 on page 3-7.

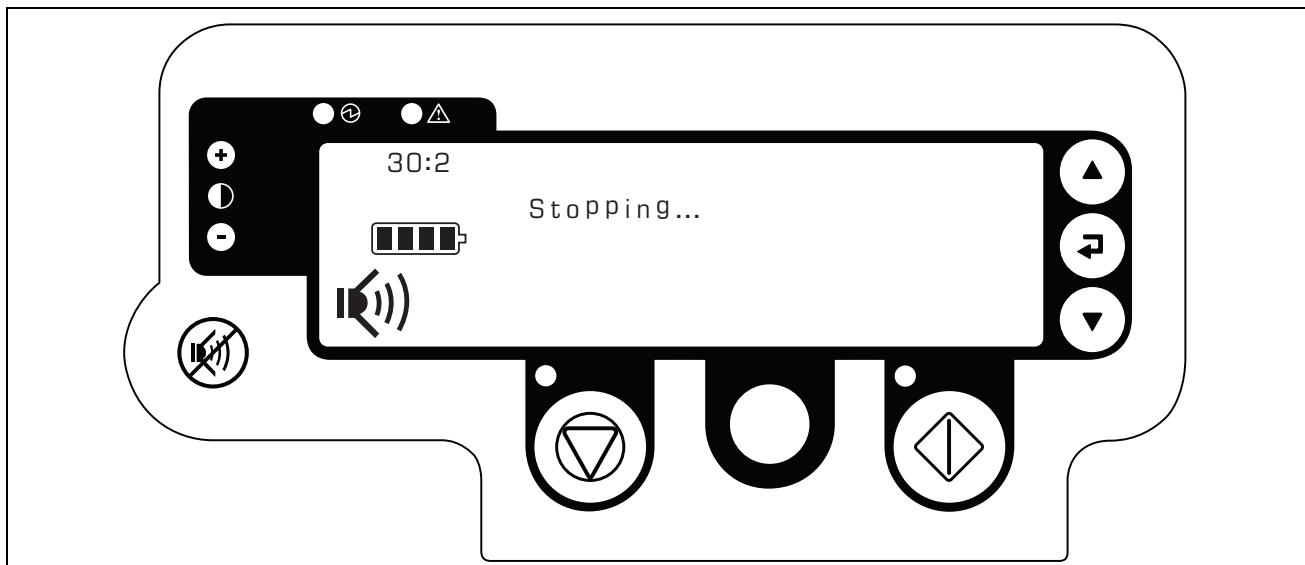

Figure 3-14 Stopping Compressions Display Panel Screen

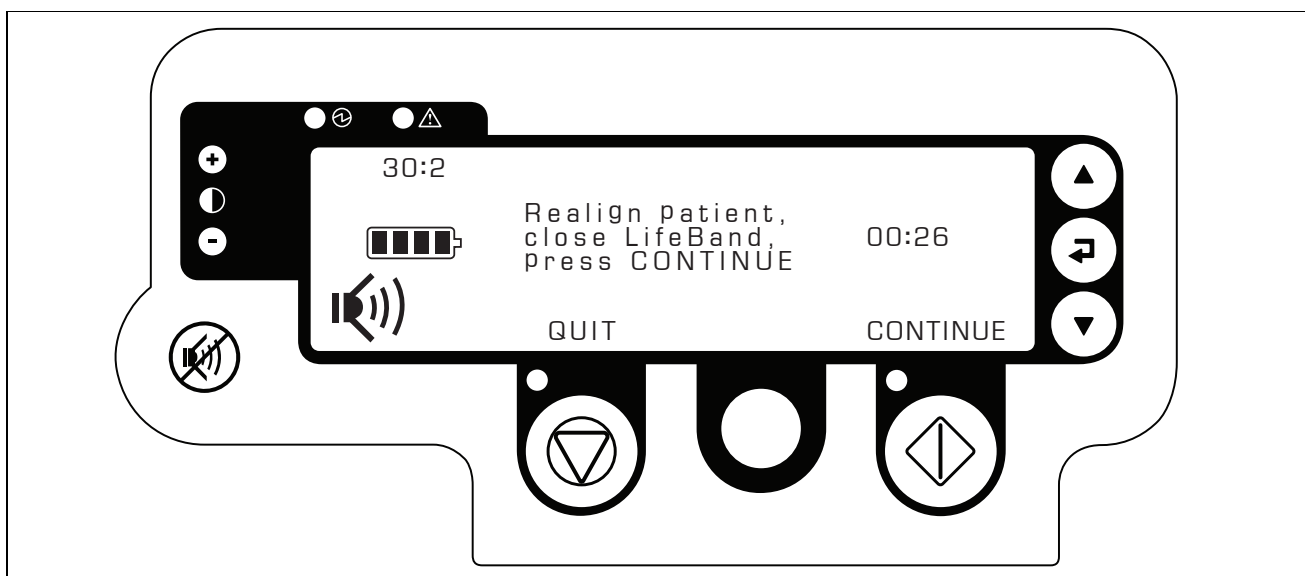

Figure 3-15 Restart/Continue Compressions Display Panel Screen

- To restart compressions, press the CONTINUE button as described in the procedure starting at step 1 on page 3-7 (see Figure 3-15).

3.3 Ending Active Device Use

1. After either successful resuscitation or termination of activities, press the Stop/Cancel button followed by the On/Off button. The Stop/Cancel button action will cease the compression cycles and relax the LifeBand (see Figure 3-14). The On/Off button action will power down the Platform.
2. Open the Velcro[®] fastener and lift or log roll off the patient from the Platform, as necessary.

3.4 Preparing the Platform for Its Next Use

1. Remove the LifeBand from the Platform. Refer to Section 2.1.2, “Removing the LifeBand” for more information.
2. **Discard the LifeBand as it is a single-use component. Treat the LifeBand as contaminated medical waste and dispose of it accordingly.**
3. Clean the Platform before its next use. Refer to Section 4.2, “Cleaning the Platform” for more information.
4. Replace the LifeBand before returning the Platform to service. Refer to Section 2.1.1, “Installing the LifeBand” for more information.
5. Remove the Battery.

Note: Ensure that the Platform is powered down before removing and replacing the Battery.

6. Replace the Battery with a fully charged Battery before returning the Platform to service.
7. Recharge the used Battery as necessary for future use.

3.5 Periodic Electrocardiogram (ECG) Monitoring and/or Defibrillation

When the Platform is used in conjunction with defibrillators or with other therapeutic devices that must monitor an ECG signal, interruption of the compression cycles may be required to avoid ECG motion artifact associated with mechanical chest compressions.

To temporarily interrupt the Platform’s active operation, press the Stop/Cancel button.

To restart the Platform, follow the procedures in Section 3.2, “Starting Chest Compressions”.

3.6 Patient Alignment and Securing for Transport

Warning: The Platform is **not** intended for carrying or transporting a patient. The Platform should be secured to the top of a backboard or other equipment used to carry or transport the patient, if necessary. During transport, regular checks of the patient's alignment should be performed.

The Platform does not require any patient restraints to perform compressions while the patient is lying on a flat surface. However, patient restraints should be used to maintain alignment of the patient to the Platform:

- If the Platform cannot be set on a flat level surface
- If the Platform is used during extrication or during transport

The Platform is designed to accept standard restraints to maintain patient alignment. The rescuer can secure a patient of up to **300 pounds** to a backboard and maneuver the patient as necessary while the Platform is performing active compressions.

Caution: Motion can cause the patient to shift and restraints to loosen, so care should be given to the initial strapping for alignment of the patient to the Platform. Regular checks of patient alignment to the Platform and alignment of the LifeBand to the patient's mid-axillary line should be made if the Platform is performing active compressions, or before active compressions are restarted.

When transporting the patient, lift by supporting the patient and the Platform onto the transportation device (for example, a gurney, backboard, AutoPulse Quick Case, or AutoPulse Soft Stretcher) and place the Platform and patient within the vehicle during Platform operation. Secure the Platform and patient to the transportation device.

The Platform can be used in conjunction with a transportation device during transport to hospital (a gurney or backboard). However, care must be taken to ensure that the patient is properly strapped to the transportation device using locally-approved procedures for safe transport.

Caution: Do not use the Platform alone as a patient transportation aid.

Caution: Straps or restraints used for transportation purposes **must not interfere** with the operation of the Platform. Specifically, straps across the patient's chest may restrict the compression/decompression of the chest. In general, strapping schemes must not alter the alignment of the patient to the Platform.

3.6.1 Recommended Method of Patient Extrication

This extrication method includes the AutoPulse Shoulder Restraint, Head Immobilizer, and Soft Carry Stretcher.

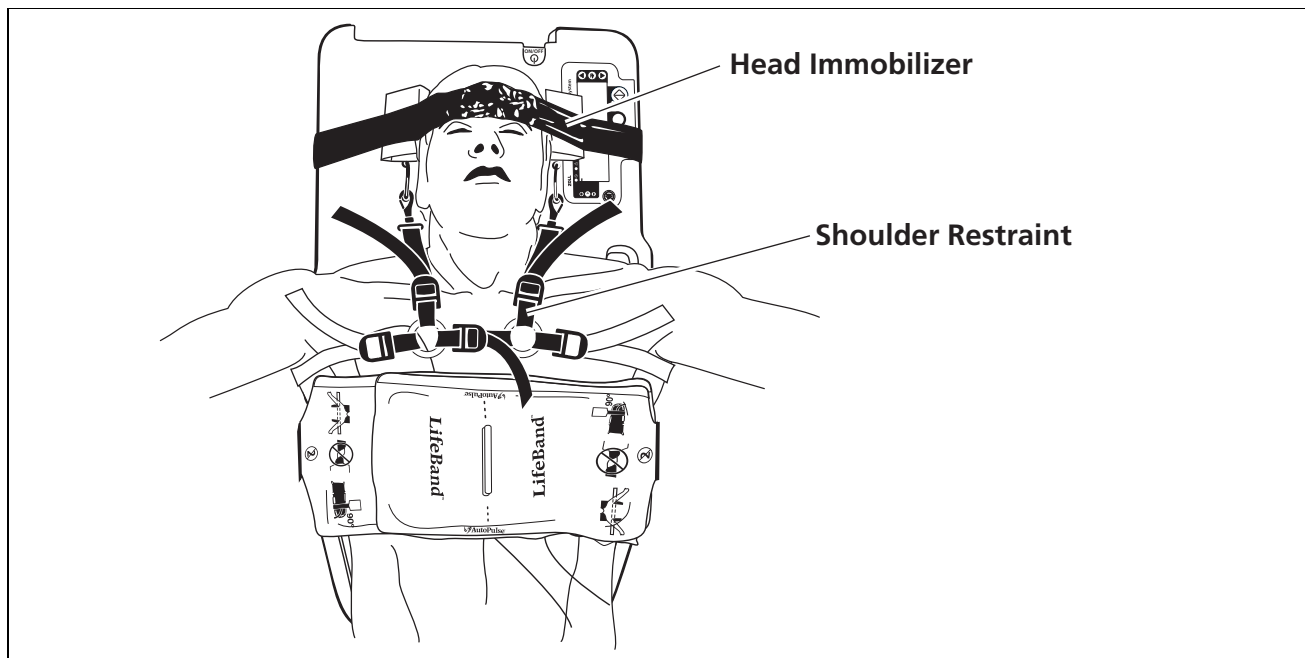

Figure 3-16 *Securing the Patient for Transport*

1. Attach the Shoulder Restraint to keep the patient properly aligned on the Platform.
2. The Head Immobilizer assists in keeping the patient's head from moving, especially when combined with a cervical collar. A cloth may also be placed under the patient's head.



Figure 3-17 *Transporting the Patient*

3. When lifted, the Soft Stretcher has a cradling effect that helps maintain alignment of the patient on the Platform. Users can also allow the patient's lower legs to bend freely at the knees, facilitating moving around tight corners and stairwells. The Platform may also be secured to a backboard using standard straps or backboard cable ties.

Always ensure the following:

1. Make sure that the patient's armpits and the upper edge of the LifeBand are aligned with the yellow line on the Platform.
2. Make sure that the LifeBand is not twisted and properly mated with the Velcro®.
3. Maintain the LifeBand at 90 degrees with the Platform. Ensure that the LifeBand is not impeded by anything such as the patient's arms, clothing, straps, and buckles that may interfere with the movement of the LifeBand.

For more information about strapping and patient restraint options, contact ZOLL at +1.800.348.9011 (or +1.978.421.9655).

3.7 Viewing Platform Information

On initial power-up, pressing the Menu/Mode Switch button allows you to:

1. Enter Communication mode (refer to Section 3.8.1, step 3 on page 3-20)
2. View last patient session information
3. View Platform information
4. View Battery information

Items 2-4 above may also be accessed from the Administrative Menu (refer to section Section 2.3, “Administrative Menu: User Pre-set Options,” on page 2-10).

Once the Menu or Administrative Menu is active use the Move Up and Down arrow buttons to highlight the desired menu item and the Select Choice Button to select it.

Information presented about the Last Patient session is:

1. Total compressions
2. Total active time (min:sec)
3. Total pause time (min:sec)

The last patient session data is updated after the Platform is power cycled and one complete compression occurs.

Information presented about the Platform is:

1. Model number
2. Serial number
3. Software version
4. Name of manufacturer
5. Manufacturer location (city, state, country)

Information presented about the Battery is:

1. Battery serial number
2. Number of charge cycles performed

From any of the information displays, press the gray Menu/Mode Switch button under the word “back” to return to the main Menu or Administrative Menu.

To exit from the menu, press the gray Menu/Mode Switch button under the word “back.” The Platform returns to the idle state, ready for patient alignment.

To exit from the Administrative Menu, press the “START” (green) button under the word “RESTART.” The Platform will restart and place you into the idle state, ready for patient alignment.

3.8 Uploading Platform Information to your PC

The Platform has an infrared communication port located on the top (“head”) edge of the unit just below the On/Off button (see Figure 3-1). This port is provided to allow upload of the information from the platform. Currently the platform will upload the patient information from at least the last three patient sessions (and potentially many more depending on the length of the resuscitation efforts). The uploaded patient information consists of the key timing information on the Platform use.

Prior to using the Platform infrared communication port, the Code Review software must be installed on your host computer. This software may be acquired from ZOLL Data Systems (www.zolldata.com) or from your ZOLL Data Systems representative (+1.978.421.9655). Installation instructions, the software's User Guide and system requirements are provided with the software. The computer with Code Review installed must be equipped with an infrared communication adapter listed below.

- iFoundry InfraRed Communication Module (serial port 8001A or USB port 8003A)
- Actisys InfraRed Communication Module

To purchase an infrared adaptor, please contact ZOLL.

3.8.1 Information Upload Procedure

1. Turn on your PC (the host computer).
2. Start the Code Review software.

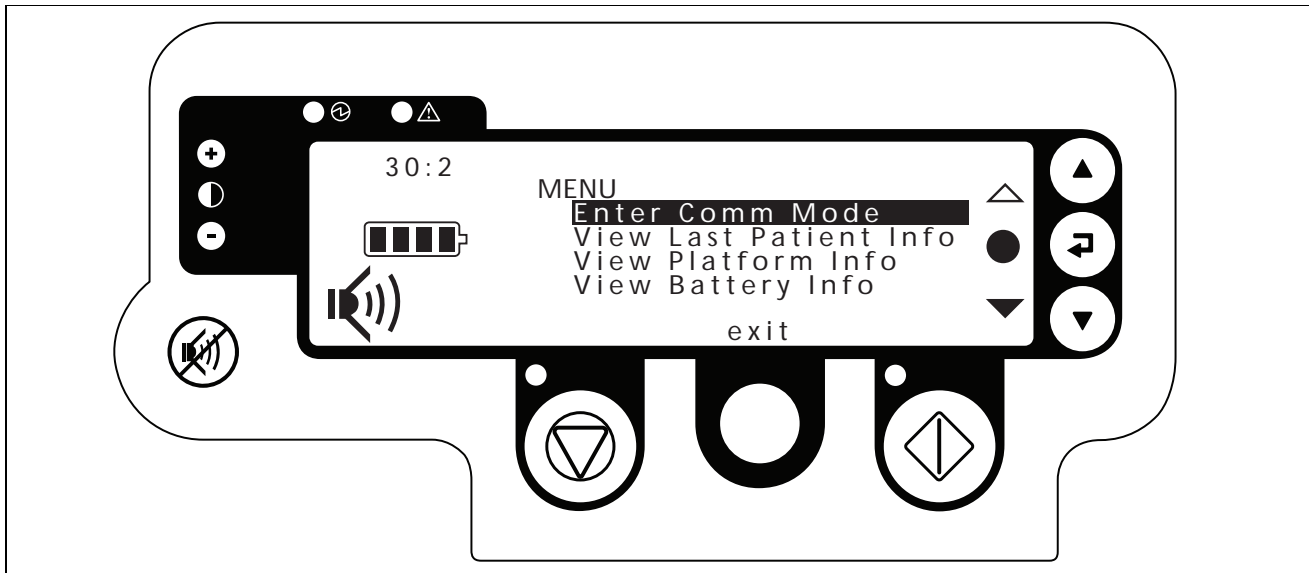

Figure 3-18 Main Menu

3. Power up the Platform and when the initialization is complete press the Menu/Mode Switch button and then select the “Enter Comm. Mode” option from the Main Menu. Alternatively you may enter directly into the Communication Mode by depressing the Menu/Mode Switch button as you power up the platform.

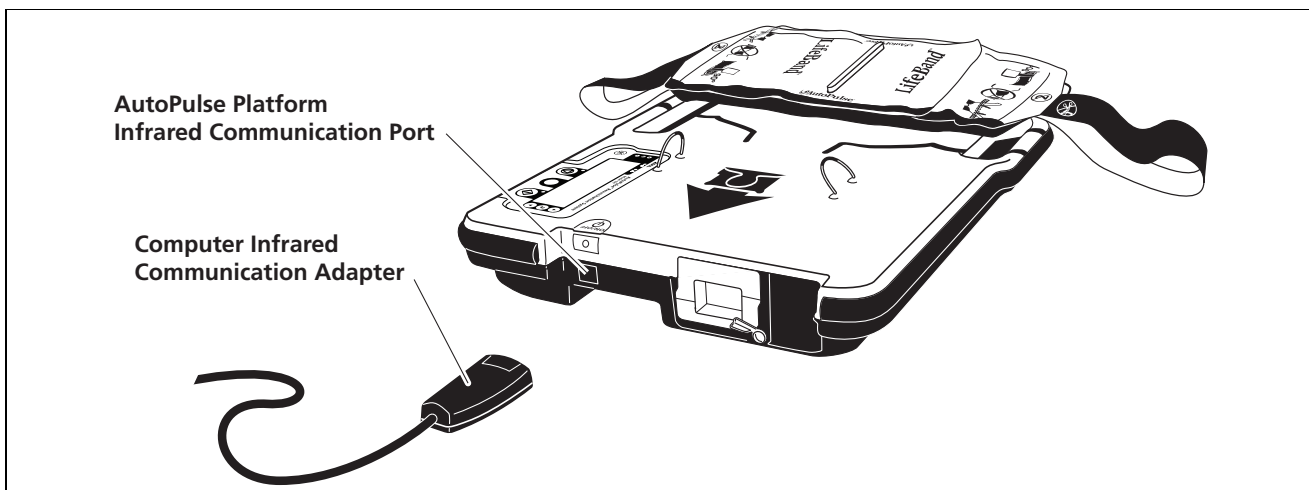

Figure 3-19 Infrared Communication Set-up

4. Aim the host computer’s infrared communication unit at the Platform infrared communication port.

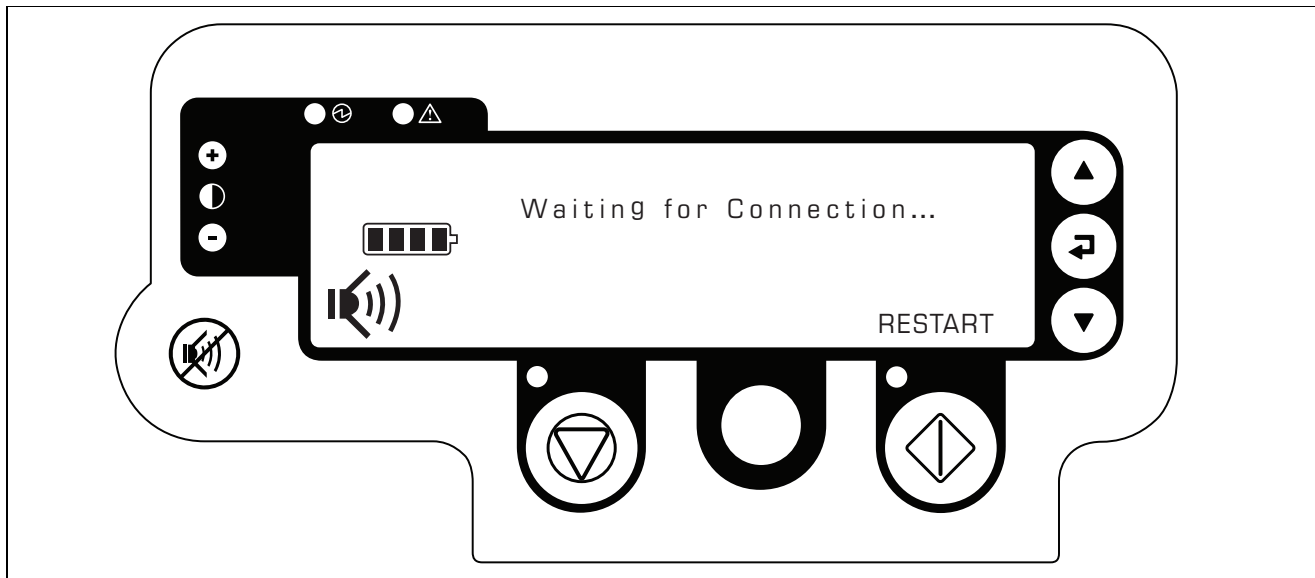

Figure 3-20 *Waiting for Connection... Display Panel Screen*

5. Upon entering the Communication Mode the platform will immediately attempt to establish a communication connection with the host computer. While this is occurring the “Waiting for Connection...” panel screen is displayed. If a connection can not be established within ten minutes the Platform will automatically power down.

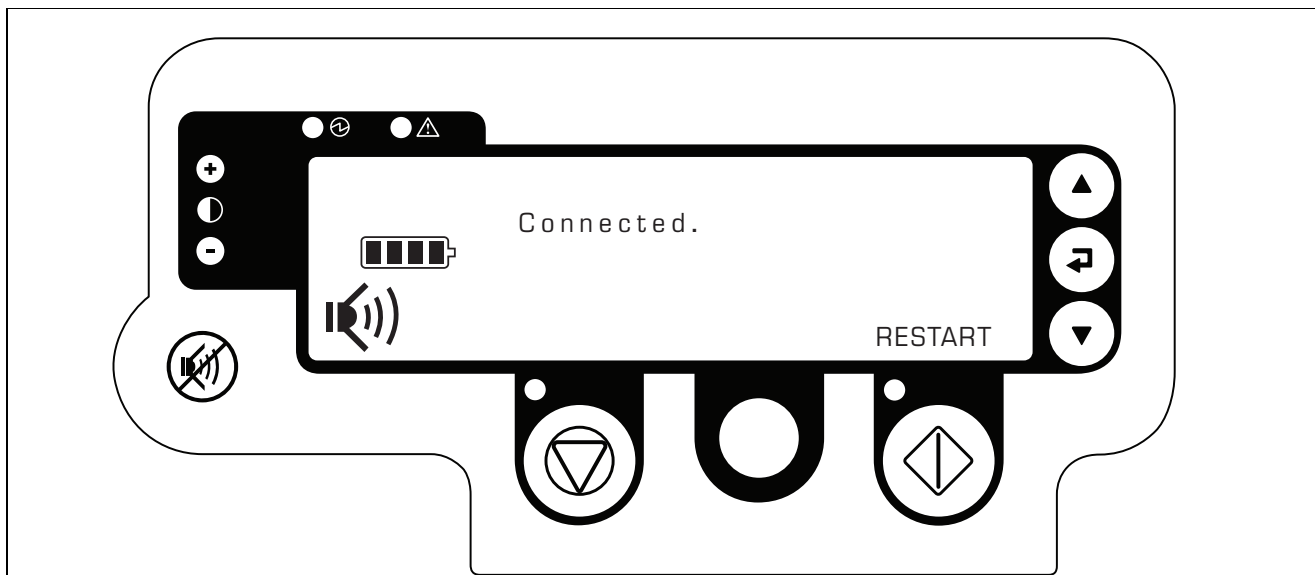

Figure 3-21 *Connected Display Panel Screen*

6. When a connection is established between the platform and your computer the “Connected” panel screen will be displayed. If a connection cannot be made within ten minutes the Platform will automatically power down.

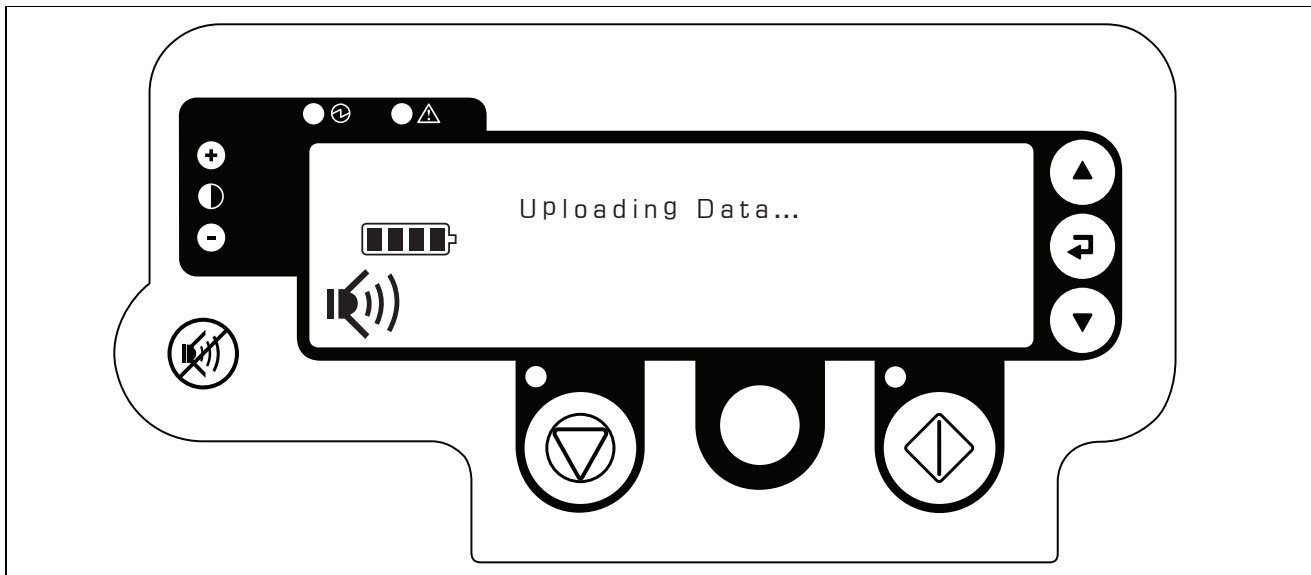

Figure 3-22 *Transmitting... Display Panel Screen*

7. From your computer send the start transmission of data command. See the Code Review software User Guide for instructions. The “Transmitting...” panel screen will be displayed while the patient information is being transferred between the platform and your computer. When the data transfer is complete the panel screen will return to the Connected display (see Figure 3-21). If while transmitting data the Platform loses communication with the host computer it will automatically try to reestablish the connection: repeat procedure starting at step 5 on page 3-21 (see Figure 3-20).
8. To exit from the Communication mode, either power down the platform by pressing the On/Off button or press the “START” (green) button under the word “RESTART.” The Platform will restart and place you into the idle state, ready for patient alignment.

4 Maintaining the AutoPulse System

4.1 Charging Batteries in the Battery Charger

The Battery Charger can charge and maintain up to two Li-Ion Batteries.

To charge a Battery, follow these steps:

1. Slide the Battery into an available charging bay (see Figure 4-1). Make sure that the Battery locks into place (locking bar engaged).

Caution: Remove the protective plastic cap from the Battery Connector before attempting to charge the Battery.

Note: For optimal charging, make sure that the Battery is at room temperature before insertion into the Battery Charger.

Note: If a Li-Ion Battery's internal temperature is below a nominal 41°F (5°C), the Battery will fail to charge in the Battery Charger. If a Battery is retrieved from cold storage or extensive exposure to cold weather, allow the Battery to warm to room temperature (may take up to three hours) before insertion into the Battery Charger.

Note: Do not slam a Battery into the Battery Charger because doing so may cause damage to the Battery's Connector.

Note: The Battery is mechanically keyed so that it can only be inserted in one orientation. Do not force a Battery into a charging bay. If resistance is met, check for appropriate orientation, and check to ensure that there are no obstructions to battery insertion.

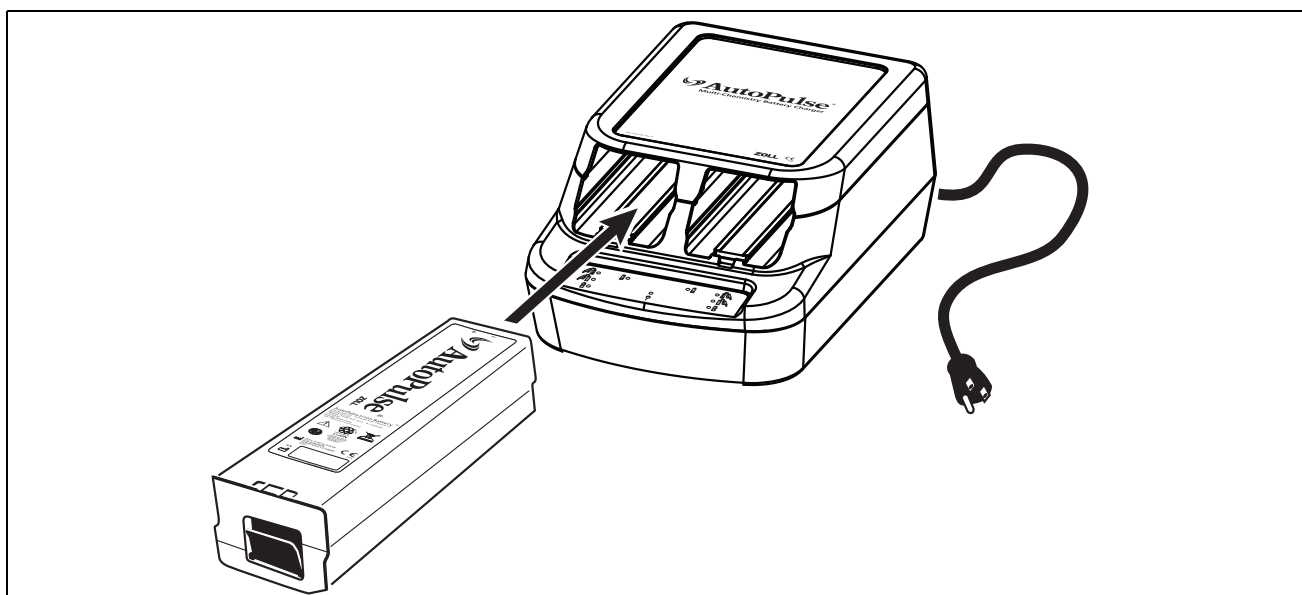

Figure 4-1 Battery Charger with Charging Bay

2. The Battery Charger automatically detects the presence of the Li-Ion Battery within 5 seconds.
3. The Battery Charger’s status will be indicated on the control panel (see Figure 4-2).

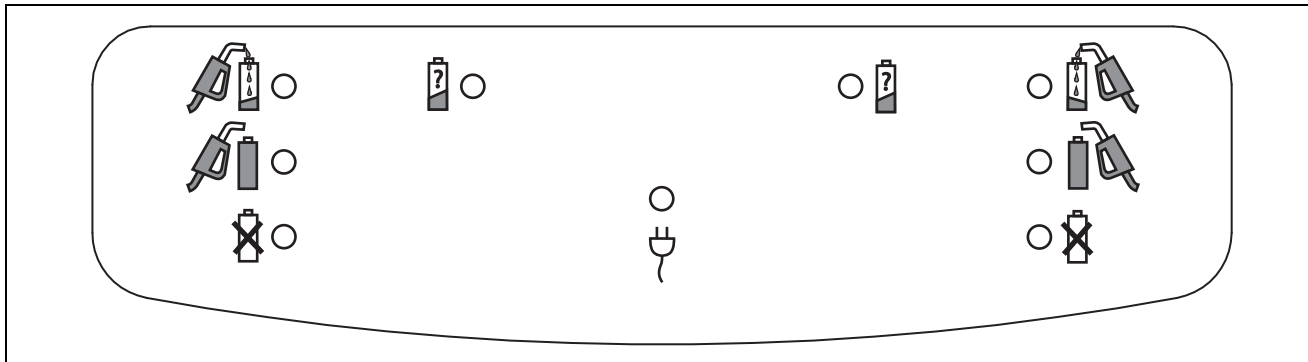

Figure 4-2 *Battery Charger Control Panel*

4. The Battery Charger will automatically perform a Test-Cycle when needed. This will automatically occur at a minimum of once every 30 days (For more information, refer to the AutoPulse Power System User Guide).

Note: Do not remove a Li-Ion Battery from the Battery Charger until its charging completes or the Battery’s runtime will be reduced.

Note: Do not remove a Li-Ion Battery during a test-cycle or the Battery’s runtime will be unknown. Removing a Battery during a Test-Cycle will cause the Battery Charger to automatically enter a Test-Cycle mode the next time the Battery is inserted into it.

5. To remove a Battery from the Battery Charger, grip the Battery while pulling the finger latch out to disengage the locking bar. Pull the Battery straight out until it fully clears the charging bay.

Note: Newly-charged Batteries can be warm to the touch. This is a consequence of normal operation.

4.2 Cleaning the Platform

1. Remove and dispose of the LifeBand.
2. Wipe all the surfaces of the Platform free of foreign matter and spills with a disinfectant or bactericidal wipe. Check the vents to ensure that they are free and clear of any obstructive matter.

Caution: Do *not* submerge the Platform in liquid.

Caution: Do not autoclave the Platform, the LifeBand, or the AutoPulse Power System.

3. Ensure that the Platform is dry before storing.

4.3 Storing the Platform

1. The Platform should be powered down before it is stored.
Note: The Platform will automatically power down after 10 minutes of inactivity.
2. The Platform should be returned to a Carry Case, Hygiene Barrier or Hospital Transporter before being stored. To purchase a Carry Case, Hygiene Barrier or Hospital Transporter, please contact your ZOLL representative by calling +1.800.348.9011 or +1.978.421.9655.
3. The Platform should always be stored in a cool, dry place.
4. Storage of the Platform in a wet or humid environment may result in damage to the platform that may require service. To prevent this from occurring, conduct the AutoPulse Self-Test daily, which includes cycling the power.
5. The Li-Ion Battery should be stored in a powered-on Battery Charger unless the Battery is deployed in the Platform.

Caution: Do not store a Battery in the Platform when the Platform is not in active service or is in extended storage. Storage in the Platform longer than a week may result in irreversible damage to a Battery.

4.4 Maintenance

The AutoPulse System has no user-serviceable parts, nor does the device require regular maintenance. There are no components that require calibration. Users should periodically inspect the AutoPulse system to ensure the device's functionality. In case of repair or service, contact ZOLL at +1.800.348.9011 or +1.978.421.9655.

Inspect the AutoPulse System as described below and follow the recommended actions as appropriate. The Platform conducts a self-test each time the device is powered on. The self-test is designed to perform a variety of internal system self-checks for the platform components, and is fully automated. A recommended AutoPulse Daily Checklist is located in Appendix A.

1. Inspect the platform for physical damage, including cracks, tears and missing or broken pieces. Contact ZOLL as needed.
2. Remove the Battery from the Platform.
3. Inspect the battery compartment for foreign substances, be sure it is free and clear for battery insertion. Remove any foreign matter or debris.
4. Check the vent openings on the bottom-side of the platform, ensure they are free and clear to allow air flow. Remove any foreign matter or debris that may block the flow of air.
5. Check the shaft opening where the belt clip is inserted for foreign substances. Blow out the opening using compressed air or micro-duster. Do not insert tools or other objects into the opening.

6. Perform battery rotation after every use, or at least once every 24 hours. Use either the Three-Battery Rotation or the Four-Battery Rotation method, as follows:
 - Three-Battery Rotation: Place the Battery that was removed from the Platform in step 2 into the Battery Charger for charging. Check the spare Battery for Green LEDs, and then place it into the Platform. Take a fully charged Battery from the Battery Charger, and use it as a spare Battery.
 - Four-Battery Rotation: Place the Battery that was removed from the Platform in step 2 into the Battery Charger for charging. Remove the spare Battery, and place it into the Battery Charger. Take two fully charged Batteries from the Battery Charger, check for Green LEDs on each Battery, and then place one into the Platform, and use the second as a spare.
7. Perform AutoPulse Self-Test daily:
 1. Ensure that a LifeBand is installed.
 2. Ensure that a fully charged Battery is installed, and power on the Platform.
 3. On power up, all LEDs on the display will momentarily light up, and then only the Green POWER LED will remain lit.
 4. The Battery Charge Status Icon on the Platform User Control Panel should also be visible with 4 bars; if not, replace the Battery with a fully charged Battery from the Battery Charger.
 5. If the Platform RED ALERT LED remains on, refer to Chapter 5, “Troubleshooting Procedures”. If the RED LED can not be resolved, contact ZOLL.

Inspect the Battery in accordance with the inspection checklist provided below. Follow the recommended actions as appropriate. The Battery is automatically checked each time the device is powered on.

1. Inspect the Battery, including the connector for physical damage that would preclude its insertion in either the platform or the Battery Charger. Contact ZOLL as needed.
2. Inspect the Battery for cracks in the Battery case exposing internal components. If the Battery is damaged, do not attempt to place the Battery into the Platform- this can cause damage to the internal connector of the Platform. If damaged, do not use.

Inspect the Battery Charger in accordance with the inspection checklist provided below. Follow the recommended actions as appropriate.

1. Inspect the Battery Charger for physical damage. Contact ZOLL as needed.
 2. Inspect the battery compartments for foreign substances, be sure they are free and clear for battery insertion. Remove any foreign matter or debris.
-

If the product malfunctions or fails any of these inspections, contact ZOLL at +1.800.348.9011 or +1.978.421.9655.

4.5 Disposal and Recycling

4.5.1 Platform

Dispose of in accordance with local governing ordinances and recycling plans for electronic waste.

4.5.2 Battery Charger

Dispose of in accordance with local governing ordinances and recycling plans for electronic waste.

4.5.3 Batteries

Do not throw your batteries away or send them to municipal dumps. Call your local waste management officials for proper disposal instructions.

4.5.4 LifeBand

The LifeBand is for single-use only. Once used, treat the LifeBand as contaminated medical waste, and dispose of accordingly.

[This page left intentionally blank.]

5 Troubleshooting Procedures

In the event of a user advisory, fault or system error, the User Control Panel Alert light-emitting diode (LED) illuminates (refer to Section 1.4, “User Controls and Indicators”). Consider the information in this chapter.

Warning: If a persistent fault or system error occurs during active operation, immediately revert to manual CPR.

5.1 Troubleshooting Batteries

If a Battery’s charge falls too low, a Low Battery warning will appear on the Control Panel Display. The Low Battery warning display will be accompanied with an audio warning of four rapid beeps which will be followed by two beeps every 30 seconds until the battery is replaced or depleted. If operation continues without changing the Battery, a Replace Battery screen will appear (see Figure 5-1 and Figure 5-2). If this is the case:

- Press the On/Off button to power down the Platform.
- Replace the Battery with a new, fully-charged Battery. Press the On/Off button followed by the Start/Continue button again.

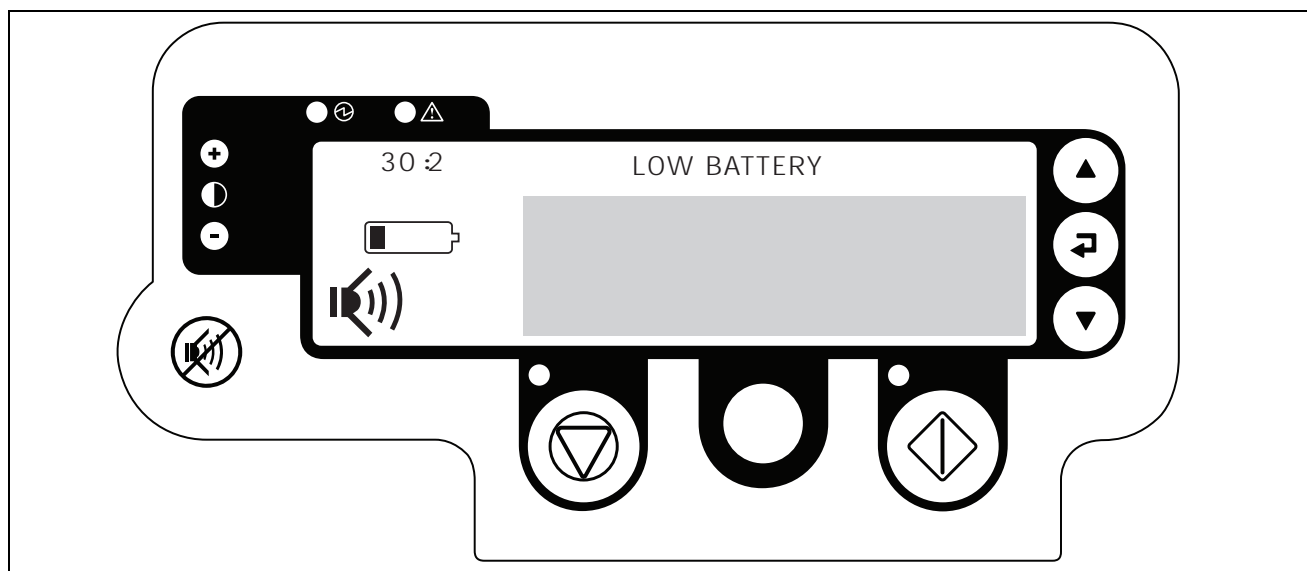

Figure 5-1 Low Battery Warning

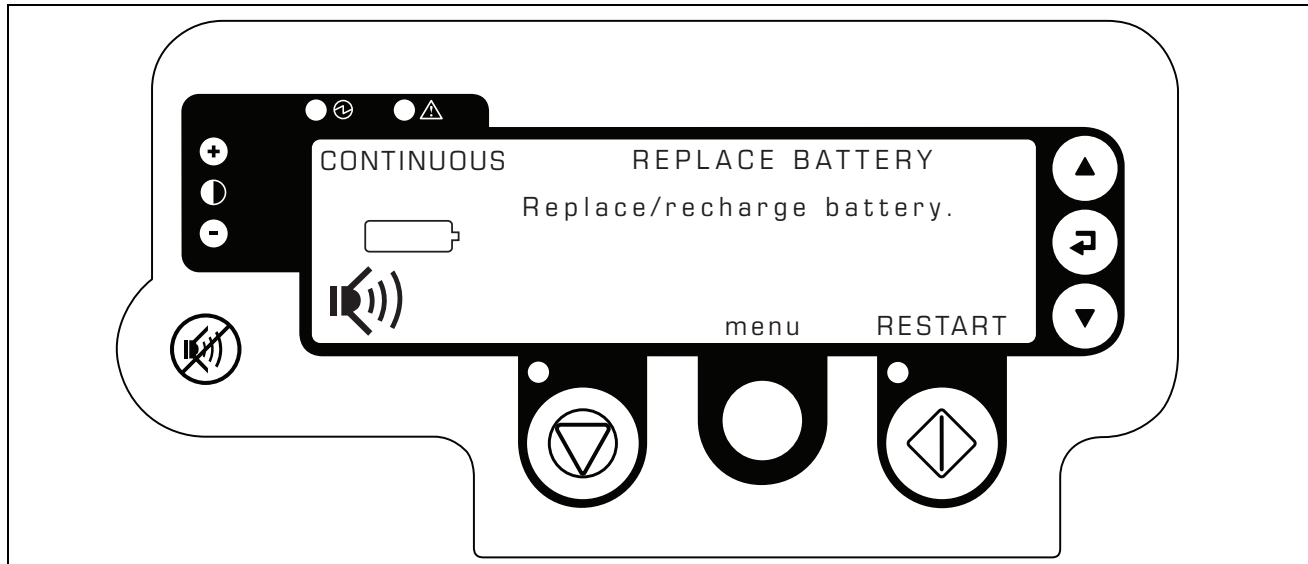

Figure 5-2 *Replace Battery Screen*

5.2 Troubleshooting User Advisories and Faults

The Platform enters a User Advisory state (see Figure 5-3) or the Fault State (see Figure 5-4) when one of several conditions is detected. A User Advisory generally indicates that a misalignment or inappropriate movement of the patient or the LifeBand has occurred. A Fault generally indicates that the Platform has detected an inappropriate internal condition. Both conditions are typically correctable by the operator. Follow the instructions on the screen and then attempt to RESTART active operation by pressing the Start/Continue button. If that does not work you should follow these general steps to troubleshoot Advisories and Faults:

1. Check for correct patient alignment (refer to Section 3.1, “Deploying the AutoPulse System” for more information), fully extend LifeBand and attempt to RESTART active operation by pressing the Start/Continue button.
2. If the user advisory or fault persists:
 - a) Remove the LifeBand from, and fully re-insert into, the Platform (refer to Section 2.1, “LifeBand Load-distributing Band”) and then press the Start/Continue button again.
 - b) Remove and replace the LifeBand with a new LifeBand and then press the Start/Continue button again.
 - c) Check the Platform for blocked vents.
3. If a User Advisory or Fault indicator cannot be cleared, record the User Advisory or Fault number and contact ZOLL at +1.800.348.9011 or +1.978.421.9655.

In either User Advisory state or the Fault State, pressing the gray Menu/Mode Switch button, under the word “menu” allows you to access the Platform information menu (refer to section Section 3.7, “Viewing Platform Information,” on page 3-18).

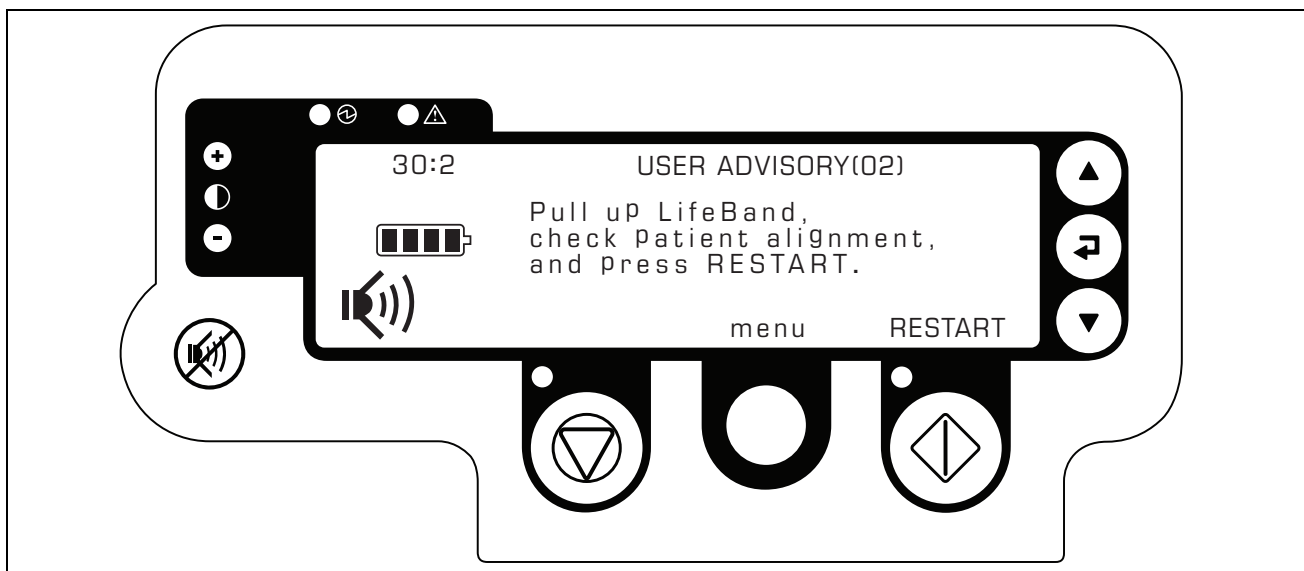

Figure 5-3 A User Advisory Screen

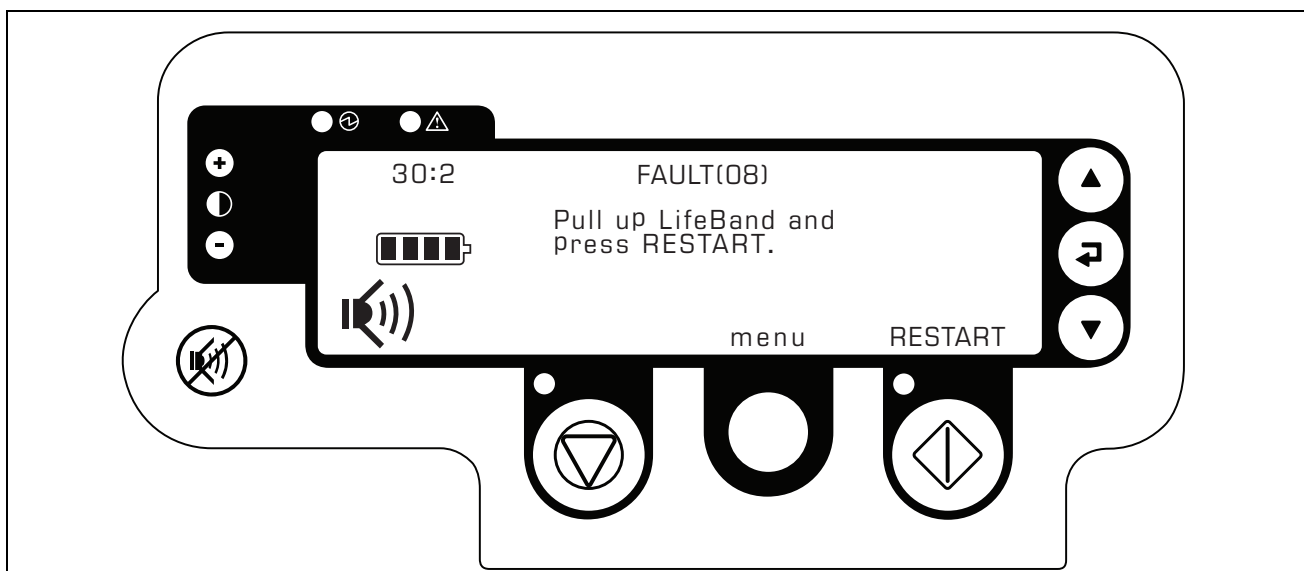

Figure 5-4 A Fault Screen

5.2.1 User Advisory (45)

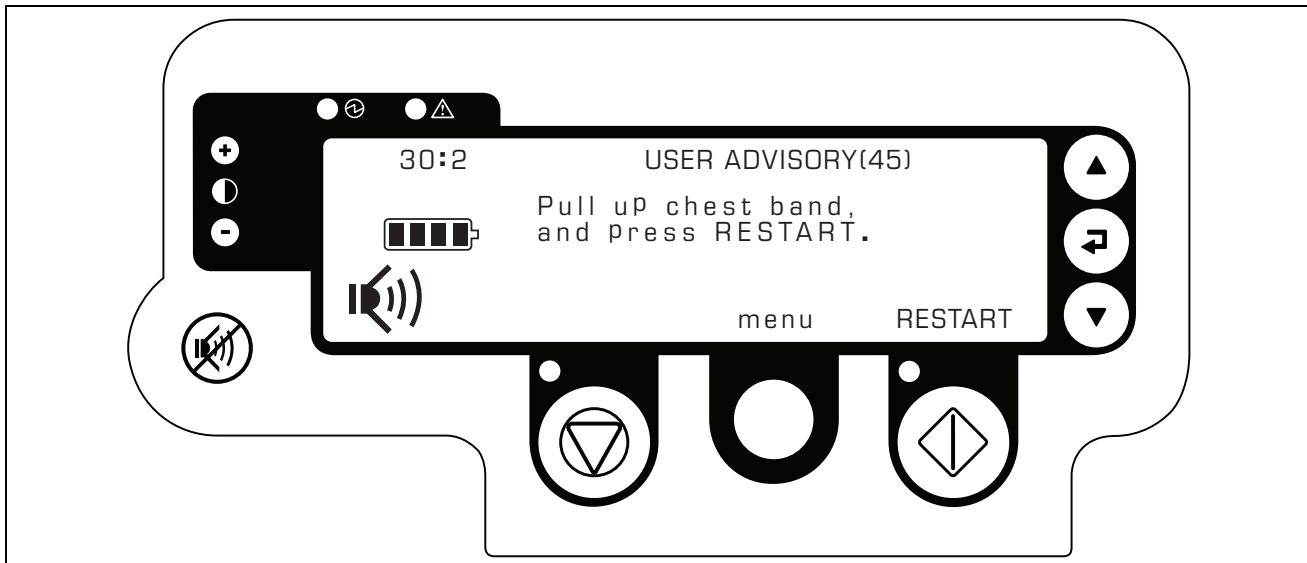

Figure 5-5 User Advisory (45)

The Platform driveshaft has a “home” position that is a point of reference for Platform operation. If the driveshaft is not at its home position when the Platform is powered on, a User Advisory (45) will occur. This User Advisory will persist until the driveshaft is returned to its home position.

To clear a User Advisory (45) pull up on the LifeBand until the chest bands are fully extended (thereby moving the driveshaft back to its home position), and then RESTART.

Warning: Removing the band clip when the driveshaft is not at its home position (see Figure 2-8 on page 2-7) will result in a permanent User Advisory (45) that the user will not be able to clear. To avoid this situation, the following guidelines should be adhered to:

1. The LifeBand should be removed from the driveshaft ONLY from its home position.
2. The LifeBand must be completely unwound with the seam visible (see Figure 2-10 on page 2-8).
3. If the LifeBand is cut, care should be taken to ensure that the bands are fully extended before the cover plate is opened and the band clip is removed.
4. Do not attempt to defeat the shaft lock mechanism, which keeps the driveshaft at its home position when a LifeBand is not installed.

If a User Advisory (45) can't be cleared, Power off the Platform and contact ZOLL at +1.800.348.9011 or +1.978.421.9655.

5.3 Troubleshooting Errors

In the event of a System Error (see Figure 5-6), **you can take no steps** to return the Platform to normal operation. The Platform has detected an unrecoverable problem and cannot be restarted. Therefore, you must:

1. Begin manual CPR immediately.
2. Contact ZOLL at +1.800.348.9011 or +1.978.421.9655.

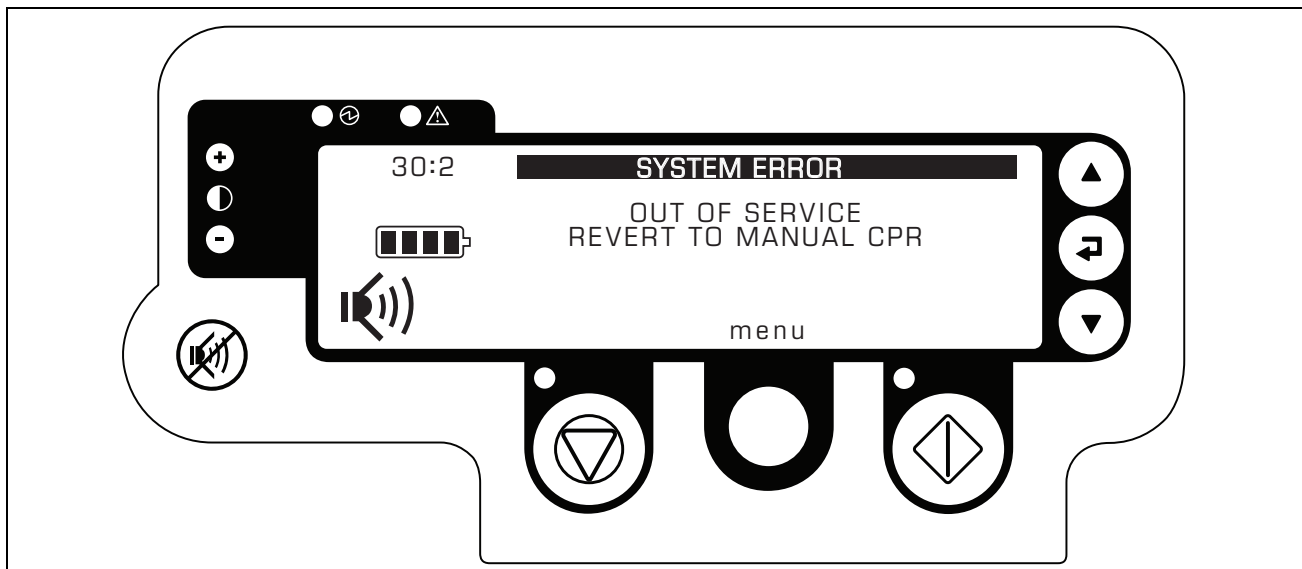

Figure 5-6 System Error Screen

[This page left intentionally blank.]

[This page left intentionally blank.]

Appendix B Technical Specifications

The specifications provided in this chapter apply to the AutoPulse Resuscitation System Model 100.

B.1 Patient Parameters

The AutoPulse System is designed for adults with weight of no more than 300 lbs. (136 kg) with chest circumference of 29.9 to 51.2 in. (76 to 130 cm) and chest width of 9.8 to 15 in. (25 to 38 cm).

Warning: The AutoPulse System is intended for use on adults, 18 years of age or older.

B.2 LifeBand

The latex-free LifeBand is for single-use only. The LifeBand consists of a cover plate and two bands integrated with a patient liner and compression pads with a Velcro® fastener.

B.3 Operating Parameters

Table B-1 Operating Parameters

Category	Specifications
Chest displacement	Equal to 20% reduction in anterior-posterior chest depth.
Physiological duty cycle	50 ± 5%.
Compression rate	80 ± 5 compressions per minute.
Compression modes (user selectable)	<ul style="list-style-type: none"> • 30:2 (30 compressions with two 1.5 second ventilation pauses) • 15:2 (15 compressions with two 1.5 second ventilation pauses) • Continuous compressions
Ventilation pause (30:2 and 15:2 mode)	Two pauses of 1.5 seconds.

B.4 Platform Physical

Table B-2 Physical Specifications

Category	Specifications
Manufacturer	ZOLL Circulation, Inc.
Size (L×W×H)	32.5 in. by 17.6 in. by 3.0 in. (82.6 cm by 44.7 cm by 7.6 cm).
Weight (excluding Battery)	20.5 lbs. (9.3 kg).
Display	Dot matrix liquid crystal display (LCD), actively backlit, adjustable contrast.

B.5 Platform Environmental

Table B-3 Environmental Specifications

Category	Specifications
Operating temperature	+32° to +104°F (0° to +40°C).
Storage/Transport temperature	-4° to +149°F (-20° to +65°C).
Relative humidity	5% to 95%, non-condensing.
Atmospheric pressure	0 to 15,000 feet above sea level (760 to 428 mmHg).
Water resistance	Water resistant as defined by IP25 per International Electrotechnical Commission (IEC) 60529.
Safety classification	Meets IEC 60601 – internally powered equipment, Type BF-Defibrillation Proof, portable, continuous operation.
Electromagnetic susceptibility	IEC 61000-4-3, 4, 5, and 6 – level 2 (80 MHz to 2 GHz, 3V/m).
Electrostatic discharge	Meets IEC 61000-4-2 – 6 KV Contact, 8 KV Air.
Electromagnetic emissions	Meets CISPR 11/EN55011, Group 1, Class A.
Patient contacting materials	Meets ISO 10993-1 Biological evaluation of medical devices.
Shock	Meets IEC 60068-2-27 Basic Environmental Testing – Shock (50 g, 11 ms pulse, half sine wave).
Vibration	<ul style="list-style-type: none"> Meets IEC 60068-2-64 Basic Environmental Testing – Random Vibration Broad Band (f1:20, f2:2000, ASD: 0.05). Meets IEC 60068-2-6 Environmental Testing – Vibration (sinusoidal), (10 to 150 Hz, 10 m/s²).
Drop	Meets IEC 60068-2-31 Basic Environmental Testing – Free Fall – Procedure 1.
Corrosion resistance	External components are non-corrosive.

B.6 Li-Ion Battery Physical and Environmental

Table B-4 Li-Ion Battery Specifications (Page 1 of 2)

Category	Specifications
Manufacturer	ZOLL Circulation, Inc.
Model Number	8700-0752-01
Size (L×W×H)	11.5 in. by 3.2 in. by 2.2 in. (29.2 cm by 8.1 cm by 5.7 cm)
Weight	3.0 lbs. (1.3 kg).
Type	Rechargeable Lithium-Ion (LiFePO ₄)
Battery voltage (nominal)	36.3 V

Table B-4 Li-Ion Battery Specifications (Page 2 of 2)

Category	Specifications
Capacity	2600 mAh (typical)
Current (maximum)	30 A continuous, 48 A pulse (96 ms max)
Initial Battery run time (nominal patient)	30 minutes (typical)
Maximum Battery charge time	Less than 4¼ hours at 77°F (25°C)
Battery Test-Cycle time	Less than 12 hours per Test-Cycle session
Recommended replacement interval	3 years from date of manufacture Note: The Battery will not operate after 5 years from date of manufacture.
Operating temperature	+32° to +113°F (0° to +45°C) ambient installed in device
Charge temperature	+41° to +95°F (5° to +35°C) ambient (68° to 77°F [20° to 25°C] preferred)
Storage/Transport temperature	-4° to +113°F (-20° to +45°C) ambient for up to six months with charging every four weeks, starting with a fully charged Battery.
Operating altitude	0 to 15,000 ft. (0 to 4,572 m)
Enclosure protection	Meets IP24 per IEC 60529
Shock	Meets IEC 60068-2-27 Basic Environmental Testing Procedures – Shock (50 g, 11 ms pulse, half sine wave)
Vibration	Meets IEC 60068-2-6 Basic Environmental Testing Procedures (10 to 150 Hz, 10 m/s ²) Meets IEC 60068-2-64 Basic Environmental Testing Procedures – Random Vibration Broad Band – General Requirements (f1:20, f2:2000, ASD 0.05)
Free fall	Meets IEC 60068-2-31 Basic Environmental Testing Procedures – Free Fall – Procedure 1.
Electrostatic discharge	Meets IEC 61000-4-2, Level 3
Radiated emissions	Meets CISPR 11/EN55011, Group 1, Class A FCC part 15, Class A
Radiated Immunity	Meets IEC-61000-4-3, 80-2500 MHz, Level 3
Safety	Meets IEC-60601-1 including UL310DV.1.1 for Lithium batteries

B.7 Battery Charger Physical And Environmental

Table B-5 Battery Charger Specifications (Page 1 of 2)

Category	Specifications
Manufacturer	ZOLL Circulation, Inc.
Model Number	8700-0753-01
Size (L×W×H)	16.01 in. by 9.50 in. by 6.54 in. (40.6 cm by 24.1 cm by 16.6 cm)
Weight	7.1 lbs. (3.23 kg)
Operating input voltage	100 to 240 V AC
Operating input frequency	50/60 Hz
Input current	2.0 Amps (maximum)
Maximum Battery charge time	Less than 6¼ hours (at 77°F [25°C])
Fuses	User-replaceable, T 2.5 AH, 250 V, 5 x 20 mm fuses (2 required) High breaking capacity: 1500 A minimum
Operating temperature	+41° to +95°F (5° to +35°C) (68° to 77°F [20° to 25°C] preferred)
Storage/Transport temperature	-40° to +158°F (-40° to +70°C)
Relative humidity	5% to 95%, non-condensing
Operating altitude	0 to 10,000 ft. (0 to 3,048 m)
Enclosure protection	Meets IP22 per IEC 60529
Shock	Meets IEC 60068-2-27 Basic Environmental Testing Procedures – Shock (50 g, 11 ms pulse, half sine wave).
Vibration	Meets IEC 60068-2-6 Basic Environmental Testing Procedures (10 to 150 Hz, 10 m/s ²). Meets IEC 60068-2-64 Basic Environmental Testing Procedures – Random Vibration Broad Band – General Requirements (f1:20, f2:2000, ASD 0.05).
Free fall	Meets IEC 60068-2-31 Basic Environmental Testing Procedures – Free Fall – Procedure 1.
Electrostatic discharge	Meets IEC 61000-4-2, Level 4.
RF electromagnetic fields immunity	Meets IEC 61000-4-3, Level 2.
EFT/burst	Meets IEC 61000-4-4, Level 3.
Surge immunity	Meets IEC 61000-4-5, Level 3.
Conducted RF disturbances immunity	Meets IEC 61000-4-6, Class A.

Table B-5 Battery Charger Specifications (Page 2 of 2)

Category	Specifications
Dips, interruptions, and variations	Meets IEC 61000-4-11.
Harmonics current emissions	Meets IEC 61000-3-2, Class A.
Radiated emissions	Meets CISPR 11/EN55011, Group 1, Class A FCC part 15, Class A.
Safety	Meets IEC/EN60601-1.

Note: These requirements provide reasonable protection against harmful electromagnetic interference in a typical medical installation. However, high level of radio-frequency emissions from electrical devices, such as cellular phones, may disrupt the performance of this device. To mitigate disruptive electromagnetic interference, position this device away from radio frequency transmitters and other sources of electromagnetic energy.

B.8 FCC Statement

This device complies with Part 15 of the FCC Rules. Operation is subject to the following two conditions: (1) The device may not cause harmful interference, and (2) this device must accept any interference received, including interference that may cause undesired operation.

B.9 Guidance and Manufacturer’s Declaration–Electromagnetic Emissions

Table B-6 Guidance and Manufacturer’s Declaration–Electromagnetic Emissions

<p>This Appendix is used to define the Manufacturer’s Declaration and Guidance concerning Electromagnetic Emissions. The Platform is intended for use in the electromagnetic environment specified below. The customer or user of the Platform should ensure that it is used in such an environment.</p>		
Emissions test	Compliance	Electromagnetic environment - guidance
RF Emissions CISPR 11	Group 1	The Platform uses RF energy for its internal function only. Therefore, its RF emissions are very low and are not likely to cause any interference in nearby equipment.
RF Emissions CISPR 11	Class A	The Platform is suitable for use in all establishments other than domestic and those directly connected to a low voltage power supply network which supplies buildings used for domestic purposes. No Mains power connection.
Harmonic Emissions IEC 61000-3-2	Not Applicable	
Voltage Fluctuations / Flicker Emissions IEC 61000-3-3	Not Applicable	
<p>Medical Electrical Equipment needs special precautions regarding EMC and needs to be installed and put into service according to EMC information provided in this document.</p> <p>Note: The EMISSIONS characteristics of this equipment make it suitable for use in industrial areas and hospitals (CISPR 11 class A). If it is used in a residential environment (for which CISPR 11 class B is normally required) this equipment might not offer adequate protection to radio-frequency communication services. The user might need to take mitigation measures, such as relocating or re-orienting the equipment.</p>		

Electromagnetic Immunity Declaration (EID)

Table B-7 Guidance and Manufacturer’s declaration – Electromagnetic immunity for Platform

The Platform is intended for use in the electromagnetic environment specified below. The customer or user of the Platform should ensure that it is used in such an environment.			
Immunity test	IEC 60601 Test Level	Compliance Level	Electromagnetic environment – guidance
Electrostatic Discharge (ESD) IEC 61000-4-2	± 8 kV contact ± 15 kV air	± 8 kV contact ± 15 kV air	Floors should be wood, concrete, or ceramic tile. If floors are covered with synthetic material, the relative humidity should be at least 30%
Electrical fast transient/burst IEC 61000-4-4	Not Applicable	Not Applicable	No mains power connection
Surge IEC 61000-4-5	Not Applicable	Not Applicable	No mains power connection
Voltage dips, short interruptions, and voltage variations on power supply input lines IEC 61000-4-11	Not Applicable	Not Applicable	No mains power connection
Power frequency (50/60 Hz) magnetic field. IEC 61000-4-8	30 A/m	30 A/m	Power frequency magnetic fields should be at levels characteristic of typical location in a typical commercial or hospital environment.

Table B-8 Guidance and manufacturer’s declaration – electromagnetic immunity

The Platform is intended for use in the electromagnetic environment specified below. The customer or the user of the Platform should assure that it is used in such an environment.

Immunity test	IEC 60601 Test Level	Compliance Level	Electromagnetic environment guidance
Conducted RF IEC 61000-4-6	Not Applicable	Not Applicable	<p>Portable and mobile RF communications equipment should be used no closer to any part of the Platform, including cables, than the recommended separation distance calculated from the equation applicable to the frequency of the transmitter.</p> <p>Recommended separation distance</p> <p>N/A 0.15 to 80 MHz</p> <p>$d = 0.35 \sqrt{P}$ 80 to 800 MHz $d = 0.7 \sqrt{P}$ 800 MHz to 2.7 GHz</p> <p>Where P is the maximum output power rating of the transmitter in watts (W) according to the transmitter manufacturer and d is the recommended separation distance in meters (m).</p>
Radiated RF IEC 61000-4-3	<p>3 V/m 80 MHz to 2.7 GHz 6 V/m in ISM bands^{***}</p> <p>Spot frequencies 385 MHz – 5.750 GHz Pulse Modulation</p>	<p>10 V/m 80 MHz to 2.7 GHz 6 V/m in ISM bands^{***}</p> <p>Spot frequencies 385 MHz – 5.750 GHz Pulse Modulation</p>	<p>Field strengths from fixed RF transmitters, as determined by an electromagnetic site survey,[*] should be less than the compliance level in each frequency range.^{**}</p> <p>Interference may occur in the vicinity of equipment marked with the following symbol:</p> 

Note 1: At 80 MHz and 800 MHz, the higher frequency range applies.
 Note 2: These guidelines may not apply in all situations. Electromagnetic propagation is affected by absorption and reflection from structures, objects, and people.

- * Field strengths from fixed transmitters, such as base stations for radio (cellular/cordless) telephones and land mobile radios, amateur radio, AM and FM radio broadcast and TV broadcast cannot be predicted theoretically with accuracy. To assess the electromagnetic environment due to fixed RF transmitters, an electromagnetic site survey should be considered. If the measured field strength in the location in which the Platform is used exceeds the applicable RF compliance level above, the Platform should be observed to verify normal operation. If abnormal performance is observed, additional measures may be necessary, such as re-orienting or relocating the Platform.
- ** Over the frequency range 150 kHz to 80 MHz, field strengths should be less than 3 V/m.
- *** The ISM (industrial, scientific, and medical) bands between 0.15 MHz and 80 MHz are 6.765 MHz to 6.795 MHz; 13.553 MHz to 13.567 MHz; 26.957 MHz to 27.283 MHz; and 40.66 MHz to 40.70 MHz. The amateur radio bands between 0.15 MHz and 80 MHz are 1.8 MHz to 2.0 MHz, 3.5 MHz to 4.0 MHz, 5.3 MHz to 5.4 MHz, 7 MHz to 7.3 MHz, 10.1 MHz to 10.15 MHz, 14 MHz to 14.2 MHz, 18.07 MHz to 18.17 MHz, 21.0 MHz to 21.4 MHz, 24.89 MHz to 24.99 MHz, 28.0 MHz to 29.7 MHz, and 50.0 MHz to 54.0 MHz.

Note: The following degradations associated with essential performance were not allowed during test: component failure, changes in programmable parameters, resets to factory defaults, changes in operating modes, or data corruption.

Table B-9 Recommended separation distances between portable and mobile RF communications equipment and the Platform

The Platform is intended for use in an electromagnetic environment in which radiated RF disturbances are controlled. The customer or the user of the Platform can help prevent electromagnetic interference by maintaining a minimum distance between portable and mobile RF communications equipment (transmitters) and the Platform as recommended below, according to the maximum output power of the communications equipment.			
Radiated maximum output power of transmitter W	Separation distance according to frequency of transmitter m		
	150 kHz to 80 MHz $d = 1.17 \sqrt{P}$	80 MHz to 800 MHz $d = 0.35 \sqrt{P}$	800 MHz to 2.5 GHz $d = 0.70 \sqrt{P}$
0.01	0.12	0.04	0.07
0.1	0.37	0.11	0.22
1	1.17	0.35	0.70
10	3.70	1.11	2.22
100	11.70	3.50	7.00
For transmitters rated at a maximum output power not listed above, the recommended separation distance d in meters can be determined using the equation applicable to the frequency of the transmitter, where P is the maximum output power rating of the transmitter in watts according to the transmitter manufacturer.			
Notes:			
1. At 80 MHz and 800 MHz, the separation distance for the higher frequency range applies.			
2. These guidelines may not apply in all situations. Electromagnetic propagations affected by absorption and reflection from structures, objects, and people.			

Medical Electrical Equipment needs special precautions regarding EMC and needs to be installed and put into service according to the EMC information in this manual.

Portable and mobile RF communications equipment can affect Medical Electrical Equipment.

The use of Accessories, transducers, and cables other than those specified by the manufacturer, may result in increased Emissions or decreased Immunity of the AutoPulse System.

The AutoPulse System should be observed to verify normal operation in the configuration in which it will be used.

B.10 Limited Warranty for AutoPulse Resuscitation System

ZOLL Circulation, Inc. (ZOLL Circulation) warrants to the initial Purchaser only that the “Warranted Product” purchased hereunder will be free from defects in workmanship or materials, when given normal, proper, and intended usage, for a specified period (“Warranty Period”) from the date of its initial shipment to Purchaser. “Warranted Products” consist solely of those products whose description in this price list expressly states that the product includes a warranty for a specified time period (the Warranty Period for the product). Excluded from this warranty are expendable components and supply items such as the LifeBand® Load-distributing Band.

Warranty Period: The AutoPulse Resuscitation System Platform, the AutoPulse Li-Ion Battery, and the Battery Charger (collectively and individually referred to as “Product”) are sold with a one year warranty period to the end-user. The warranty period begins at delivery.

ZOLL Circulation’s sole obligations under this warranty are to repair or replace, at its option, any Warranted Product (or part thereof) that ZOLL Circulation reasonably determines to be covered by this warranty and to be defective in workmanship or materials provided that the Purchaser has given notice of such warranty claim within the Warranty Period and the Purchaser has complied with ZOLL Circulation’s Return Material Authorization (“RMA”) procedures. Repair or replacement of Products under this warranty does not extend the Warranty Period.

To request repair or replacement under this warranty, Purchaser should contact ZOLL Circulation Inc. 2000 Ringwood Avenue, San Jose, CA 95131, 1-(408) 541-2140 (*main*) 1-(408) 541-1030 (*fax*). ZOLL Circulation will inform purchaser of its then-current RMA procedure. ZOLL Circulation shall determine whether to repair or replace Products and parts covered by this warranty and all Products or parts replaced shall become ZOLL Circulation’s property. In the course of warranty service, ZOLL Circulation may but shall not be required to make engineering improvements to the Warranted Product or part thereof.

Exclusions

This warranty does not extend to any Warranted Products or parts thereof that have (a) been subject to misuse, neglect or accident; (b) been damaged by causes external to the Warranted Product, including but not limited to failure of or faulty electrical power; (c) not been used in accordance with ZOLL Circulation’s instructions; (d) been affixed to any nonstandard accessory attachment; (e) had the serial number removed or made illegible; (f) been modified by anyone other than ZOLL Circulation; (g) been used with any software not provided by ZOLL Circulation; or (h) been disassembled, serviced, or reassembled by anyone other than ZOLL Circulation, unless authorized by ZOLL Circulation. ZOLL Circulation shall have no obligation to make repairs, replacements, or corrections which result, in whole or in part, from normal wear and tear.

ZOLL Circulation makes no warranty (a) with respect to any products that are not Warranted Products, (b) with respect to any products purchased from a person other than ZOLL Circulation or a ZOLL Circulation-authorized distributor or (c) with respect to any product sold under a brand name other than ZOLL Circulation.

THIS WARRANTY IS THE SOLE AND EXCLUSIVE WARRANTY FOR ZOLL CIRCULATION'S PRODUCTS, EXTENDS ONLY TO THE PURCHASER AND IS EXPRESSLY IN LIEU OF ANY OTHER EXPRESS OR IMPLIED WARRANTIES INCLUDING WITHOUT LIMITATION ANY WARRANTY AS TO MERCHANTABILITY OR FITNESS FOR A PARTICULAR PURPOSE. ZOLL CIRCULATION'S MAXIMUM LIABILITY ARISING OUT OF THE SALE OF THE PRODUCTS OR THEIR USE, WHETHER BASED UPON WARRANTY, CONTRACT, TORT OR OTHERWISE, SHALL NOT EXCEED THE ACTUAL PAYMENTS RECEIVED BY ZOLL CIRCULATION IN CONNECTION THEREWITH. ZOLL CIRCULATION SHALL NOT BE LIABLE FOR ANY INCIDENTAL, SPECIAL OR CONSEQUENTIAL LOSS, DAMAGE OR EXPENSE (INCLUDING WITHOUT LIMITATION LOST PROFITS) DIRECTLY OR INDIRECTLY ARISING FROM THE SALE, INABILITY TO SELL, USE OR LOSS OF USE OF ANY PRODUCT (HOWEVER CAUSED AND ON ANY THEORY OF LIABILITY), EVEN IF ZOLL CIRCULATION HAS BEEN ADVISED OF THE POSSIBILITY OF SUCH LOSS. THE FOREGOING LIMITATIONS SHALL NOT APPLY TO ANY CLAIMS FOR BODILY INJURY OR DEATH TO THE EXTENT THAT LIMITATION OF DAMAGES FOR SUCH CLAIMS ARE UNENFORCEABLE OR AGAINST PUBLIC POLICY UNDER ANY APPLICABLE STATUTE OR RULE OF LAW.

Index

A

- active device use
 - ending 3-14
- Administrative Menu 2-11
- Alert LED 1-8
- AutoPulse
 - battery 1-3
 - cleaning 4-2
 - components 1-2
 - deploying 3-1
 - description 1-1
 - ending active device use 3-14
 - interrupting 3-14
 - introduction 1-1
 - maintenance 4-3
 - operating characteristics 1-10
 - operating parameters B-1
 - platform 1-2
 - starting chest compressions 3-7
 - storing 4-3
 - technical specifications B-1
 - troubleshooting 5-1
 - viewing system information 3-18
- AutoPulse Multi-Chemistry Battery Charger
 - troubleshooting A-1
- AutoPulse Platform
 - viewing system information 3-18
- AutoPulse System
 - warranty B-11

B

- Batteries
 - troubleshooting 5-1
- Battery 1-3
 - capacity B-3
 - charge time B-3
 - specifications B-2
 - test-cycle time B-3
- Battery charge icon 1-10
- Battery charge status 1-8
- button
 - increase/decrease contrast 1-8

C

- Chest bands
 - See Lifeband
- Chest Compression Assembly(CCA)
 - See Lifeband
- chest compressions
 - starting 3-7
- chest displacement 1-1, B-1
- cleaning AutoPulse Platform 4-2
- Code Review software 3-19
- compression
 - depth 1-10
 - interrupting 3-14
 - mode 1-6, 1-10, 2-10, B-1
 - rate 1-10, B-1
 - starting 3-7
- Compression modes
 - Setting 2-12
- contrast, display panel 1-8

D

- data upload 3-19
- decrease contrast button 1-8
- defibrillation 3-14
- device use
 - ending 3-14
- driveshaft 2-1, 2-7
- duty cycle 1-10

E

- ECG monitoring 3-14
- error
 - troubleshooting 5-5

F

- fault
 - troubleshooting 5-2

G

- green LED 1-8

H

- head immobilizer 3-16

I

- increase/decrease contrast button 1-8
- infrared communication adapter 3-19
- infrared communication port 3-19

installation

LifeBand 2-1

interrupting compression cycles 3-14

L

Last patient information 2-10, 3-18

LCD B-1

LifeBand

band clip 2-1

cover plate 2-1

cutting 2-4, 2-7

damage 3-7

fastening 3-7

hinged belt guards 2-3

Home Position 2-7

installation 2-1

patient positioning 3-5

plate alignment arrow 2-1

removal 2-4, 2-7

limited warranty B-11

Load-distributing Band

See Lifeband

M

maintenance 4-3

Menu/Mode Switch button 1-6, 3-18, 3-19, 3-20

Mode Switch button 1-6

Multi-Chemistry Battery Charger

diagram 4-1

Mute duration 2-10, 2-13

O

on-the-fly mode switching 3-12

operating characteristics

AutoPulse Platform 1-10

operating parameters B-1

P

patient

positioning 3-5

securing for transport 3-15

transporting 3-15

patient/AutoPulse Platform positioning 3-5

performance characteristics 1-10

physical specifications B-4

physiological duty cycle 1-1, B-1

Platform environmental specifications B-2

Platform operating parameters B-1

Platform physical specifications B-1

positioning guides 3-5

Power LED 1-8

R

red LED 1-8

S

securing patient for transport 3-15

shoulder restraint 3-16

soft stretcher 3-16

specifications

Platform environmental B-2

Platform physical B-1

Start/Continue button 1-5

Stop/Cancel button 1-5

storage 4-3

temperature B-2

T

technical specifications B-1

temperature

operating B-2

storage B-2

test-cycle

time requirements B-3

Tone Mute 1-7

Tone Volume 2-10, 2-14

transport

securing the patient 3-15

transporting patient 3-15

troubleshooting 5-1, A-1

U

User Advisory 5-2, 5-3

User Advisory (45) 2-6, 2-7, 5-4

user control panel 1-5

user controls 1-4

V

ventilation pause B-1

W

warranty B-11

weight

AutoPulse Platform B-1
