

# Quattro<sup>®</sup> Intravascular Heat Exchange Catheter Kit Instructions for Use

**Model IC4593/8700-0783-01**

**Caution.** Federal law restricts this device to sale by or on the order of a physician.

Quattro<sup>®</sup> Intravascular Heat Exchange Catheter Kit includes:

Quantity	Description
1	Quattro catheter 3-Luer 9.3 French x 45 cm Triple Infusion Luer Extension Line Clamps Radiopaque shaft Applause heparin coated
1	Guidewire 0.032" (0.81 mm) x 90 cm
1	Vessel Dilator 10.5 F x 0.038" (3.6 mm x 1.0 mm)
1	Detachable suture tab & clip
1	18 ga x 2½" (1.3 mm x 63 mm) Radiopaque OTN catheter
1	000 Silk suture
1	Chloraprep <sup>®</sup> triple swabstick prep pack
6	4" x 4" (10 cm x 10 cm) Gauze sponges
1	No. 11 Surgical blade with long handle
1	3 cc Syringe 25 ga x 1" (0.5 mm x 2.5 cm) Needle
2	5 cc Syringes 22 ga x 1½" (0.7 mm x 3.8 cm) Needle
1	Fenestrated drape 40" x 62" (1 m x 1.5 m)
1	18 ga x 2¾" (1.3 mm x 70 mm) Needle
1	Needle disposal cup
1	SilvaSorb <sup>®</sup> site antimicrobial dressing
1	SureSite <sup>®</sup> transparent film dressing

## Device description

The Quattro intravascular heat exchange catheter ("Quattro catheter" or "catheter") is a sterile, single use flexible 9.3 F catheter designed for placement in the inferior vena cava from an insertion site in the femoral vein. The Quattro catheter is to be connected to a single use disposable ZOLL<sup>®</sup> Start-Up Kit and the Coolgard<sup>®</sup>/Thermogard<sup>®</sup> family of consoles ("console") (all supplied separately). A dilator and guidewire are required for the percutaneous insertion of the Quattro catheter. Three Luers are available for infusion and sampling.

Infusion port	Flow rate	Priming volume
Distal (brown)	1300 ml/hr	0.6 cc
Medial (white)	800 ml/hr	0.4 cc
Proximal (blue)	1100 ml/hr	0.4 cc

The catheter blood contact surfaces (tip, balloon, and shaft) are treated with an anti-thrombotic Applause heparin coating.

## Sterility

Ethylene oxide sterilized. The catheter is supplied sterile for single use only and should not be resterilized. The package should be inspected prior to use to ensure that the sterility barrier has not been compromised.

## Storage

Store in a cool, dry place. Avoid freezing and excessive heat.

## Indications for use

The ZOLL Quattro Catheter Model IC-4593, connected to a ZOLL Thermal Regulation System, is indicated for use:

- In cardiac surgery adult patients to achieve and/or maintain normothermia during surgery and recovery/intensive care, and
- To induce, maintain and reverse mild hypothermia in neurosurgery adult patients in surgery and recovery/intensive care.

## Contraindications

1. The risks of the catheter are essentially those of a central line. The catheter should not be used in patients for whom central line placement is not indicated.
2. Bleeding diathesis
3. Active sepsis
4. Infection or active bleeding at the site of catheter insertion
5. Patients with no vascular access, or a vascular system that will not accommodate a catheter, including patients with vena cava filters or other implanted impediments to passage of the catheter
6. Patients for whom the required temperature monitoring cannot be established
7. Hypothermia is contraindicated in patients who have hematological diseases that will be made worse with hypothermia (e.g. any disease that produces cryoglobulinemia, any hemoglobinopathy in which hemolytic anemia can be precipitated by cold including Sickle Cell Disease or Thalassemia).
8. Not intended for pediatric or neonatal use.

## Warnings, precautions, adverse reactions

Central venous catheterization should only be performed by well-trained personnel well-versed in anatomical landmarks and safe

technique. Personnel should also have knowledge of potential complications.

#### WARNING

The catheter should be placed via a femoral vein approach only. Do not allow the catheter to be placed into the right atrium or right ventricle. Placement in the right atrium or right ventricle can result in severe patient injury or death.

**WARNING.** The Quattro catheter and Start-Up Kit could potentially misconnect with small bore connectors from other medical devices. Such connection errors could result in patient injury or death.

**Caution.** The custom Luers contained on the catheter and Start-Up Kit may reduce the risk of misconnections, but still have the potential for misconnections with these specific medical device applications: Breathing Systems & Driving Gases applications, Enteral & Gastric applications, Urethral & Urinary applications, Limb Cuff Inflation applications, Neuraxial applications, and Intravascular or Hypodermic applications. Always use caution when connecting ZOLL catheters and Start-Up Kits to these and other medical device applications.

**Caution.** Ensure that the catheter and/or Start-Up Kit are not misconnected to an IV or other medical devices.

**Single use only.** The product is designed for single use only. Do not resterilize or reuse. Do not reinsert, once removed from the patient. Do not alter the catheter in any way. Maximum use period: 4 days.

Potential risks with re-use of a single use device include but are not limited to:

- Potentially life threatening infection
  - Toxic shock due to degradation of materials
  - Increased risk of thrombosis
  - Reduced heat exchange power
  - Device failures
1. The catheter should be positioned so that the distal tip of the catheter is in the inferior vena cava, below its junction with the right atrium and parallel to the vessel wall. X-ray examination should be used to ensure that the catheter is not in the right atrium or ventricle.
  2. Possible complications with central venous catheters include: atrial or ventricular perforation, cardiac tamponade, air embolism, catheter embolism, thoracic duct laceration, bacteremia, septicemia, thrombosis, inadvertent arterial puncture, hematoma formation, hemorrhage, nerve damage and dysrhythmias.
  3. **Caution.** If blood is observed within the saline circuit, stop the procedure and perform the check for a catheter leak.
  4. All Luer-Lock connections and covers must be securely tightened to prevent air embolism or fluid or blood loss.
  5. Never use excessive force in moving the catheter or guidewire. If resistance is encountered, an x-ray should be performed to identify the reason for the resistance.
  6. Passage of the guidewire into the right heart can cause dysrhythmias, right bundle branch block, vessel wall, atrial or ventricular perforation.
  7. Use only sterile normal saline for catheter priming. It is the circulating fluid in the catheter.
  8. The catheter should be routinely inspected for flow rate, security of dressing, correct catheter position, and for secure Luer-Lock connections. Use the centimeter markings to identify if the catheter position has changed. A potential risk associated with multi-lumen balloon catheters is a lack of therapy, including failure to infuse drug therapy through the infusion lumens.
  9. Only x-ray examination can ensure that the catheter tip has not entered the heart or no longer lies parallel to the vessel wall. If the catheter position has changed, perform an x-ray examination to confirm the catheter tip position.

10. For blood sampling, temporarily shut off the remaining infusion ports through which solutions are being infused.
11. Use only a 30 cc or smaller syringe for blood sampling.
12. Alcohol and acetone can weaken the structure of the shaft material. Care should therefore be taken when infusing drugs containing alcohol or when using alcohol or acetone when performing routine catheter care and maintenance. Alcohol should not be used to de clot the catheter.
13. Use only the ZOLL suture tab and clip provided in the kit to prevent catheter damage.
14. Use of a syringe smaller than 10 ml to irrigate or de clot an occluded catheter may cause intraluminal leakage or catheter rupture.
15. Do not infuse into the orange IN and OUT Luer-Lock connections, as this will result in lack of therapy.
16. Fever may have infectious and/or non-infectious causes in patients. Mitigation of fever as a sign of possible infection necessitates daily, meticulous assessment for other signs of infection.
17. Use care when infusing drugs that may be affected by cool temperatures (as low as 4°C). Solutions containing mannitol are temperature-sensitive and must not be delivered through the catheter except for a rapid push of a solution of up to 20% mannitol, followed by a saline flush. Higher than a 20% concentration of mannitol drip or infusion pump delivery of mannitol must be done via a separate line.
18. **Cardiac Tamponade:** Placement of indwelling catheters in the right atrium is a practice that may lead to cardiac perforation and tamponade. Practitioners placing central venous catheters must be aware of this potentially fatal complication before advancing the catheter too far relative to patient size. The actual position of the tip of the indwelling catheter should be confirmed by x-ray after insertion. Central venous catheters should not be placed in the right atrium unless specifically required for special relatively short term procedures, such as aspiration of air emboli during neurosurgery. Such procedures are nevertheless risk-prone and should be closely monitored and controlled.
19. The catheter is coated with heparin. This may induce or aggravate pre-existing heparin induced thrombocytopenia (HIT).
20. **WARNING.** When connecting infusion sets/injection systems to the catheter, do not exceed 100 psi/689 kPa.
21. For patients being made hypothermic, the hypothermia itself may exacerbate some disease states. Care should be taken to properly monitor patient homeostasis during hypothermia.
  - Cardiac rhythm disturbances—both bradycardia and ventricular tachyarrhythmia.
  - Clotting and coagulations function. Patients at risk for disturbances of their clotting or coagulation function should be closely monitored during hypothermia.
  - Blood gas and pH analysis. Hypothermia modifies resting pH and PaCO<sub>2</sub>. Physicians should be aware of the effect of temperature upon the result.
  - Prolonged hypothermia depresses the immune response and lung function.

**WARNING. Intraluminal or balloon leakage.** Intraluminal leakage (between the saline lumen and infusion lumens) or balloon leakage is a potential catheter failure mode. In the event of such a failure, sterile saline from the cooling circuit is introduced into the patient. Intraluminal leakage or balloon leakage is typically associated with a fluid loss alarm once the saline bag has been depleted and stops the system.

**Always investigate fluid level alarms.** The cooling circuit is a closed loop system – usually fluid loss alarms indicate a breach somewhere in this closed loop. With any fluid loss alarm, check both the integrity of the catheter and the Start-Up Kit (see below).

**WARNING.** If you notice a depleted saline bag or an air trap alarm, do not replace the saline bag prior to identifying the location of the leak and taking the appropriate mitigation. Check for system leaks according to the instructions in the Check for a Start-Up Kit leak and Check

for a catheter leak sections below. (Note that a leak could be external or internal.)

Replacing the saline bag repeatedly without investigating the leak or loss of saline may result in unintended infusion of saline into the patient. Saline infusion may lead to the following adverse effects: local swelling that can cause subsequent local tissue damage; systemic fluid overload that can lead to dependent edema and subsequent skin breakdown; internal organ fluid overload, with subsequent overloading of the brain, lungs or heart. In some cases, this fluid overload may lead to life threatening events.

**Caution.** The console emits an alarm when the saline bag is empty. The bag must be completely empty and additional saline must have drained between the saline spike and the air trap for the saline level in the air trap to drop sufficiently to trigger the alarm.

### Check for a Start-Up Kit leak

1. Check the air trap for condensation. If the air trap shows signs of condensation, wipe the air trap and reinstall it in the console. In the case of an air trap alarm, verify that the air trap alarm is cleared after this step.
2. Carefully check the saline path from the saline bag to the console for any leaks. Check if there is saline on the floor, console, or the patient's bed.
3. If there is any saline on the floor, console, or the patient's bed, check that the Luers on the catheter and Start-Up Kit are not cracked or damaged and that the connections are tight enough to prevent leaks.
4. If you find a leak in the Start-Up Kit, replace the Start-Up Kit and see if there is also a leak in the catheter.
5. If you do not find a leak in the Start-Up Kit, there is likely a leak in the catheter. Investigate further.

### Check for a catheter leak

1. Disconnect the Start-Up Kit from the catheter. Properly cap both the catheter and Start-Up Kit using an aseptic technique.
2. Fill a sterile 10 mL slip tip syringe with sterile saline.
3. Connect the syringe to the IN Luer of the catheter and disconnect the OUT cap. Infuse 10 mL of saline – the saline should flow out the OUT Luer. If the saline does not flow out of the OUT Luer, a catheter leak is indicated.
4. Cap the OUT Luer and pull 5 cc of vacuum. Sustain for at least 10 seconds. Up to 4 mL of saline (not blood) should enter the syringe and you should be able to maintain the vacuum. If traces of blood are seen in the syringe or vacuum cannot be maintained, it indicates a catheter leak.
5. If you find a leak in the catheter, replace the catheter.
6. Replace the saline bag and re-prime the Start-Up Kit.
7. Ensure leak-tight Luer connections to the Start-Up Kit and continue the therapy.

## Materials required

Quantity	Description
1	Quattro Catheter Kit for percutaneous introduction
1	500 cc bag of sterile normal saline (not provided)
	Start-Up Kit (provided separately)
1	<ul style="list-style-type: none"><li>• 6 ft (183 cm) standard tubing or</li><li>• 9 ft (274 cm) extended tubing</li></ul>
1	Coolgard or Thermogard console (provided separately)

## Catheter preparation and insertion

**Note.** The catheter has a radiopaque marker band to assist in identification of the catheter during and after insertion when viewed using x-ray equipment. The proximal end of the proximal balloon has one marker band. The tip of the catheter contains barium sulfate to make it radiopaque.

Use sterile technique.

**Caution.** The IN and OUT Luer-Locks on this catheter are custom-manufactured and are intended to connect only with the Start Up Kit listed in Materials required.

### Preparing the catheter

1. Place the patient in a supine position.
2. Prep and drape the puncture site as required.
3. Carefully remove the catheter from the package, leaving on the catheter membrane cover.
4. Remove the caps from the IN and OUT Luers. With the catheter cover in place, fill the syringe (5 cc or larger) with sterile saline and attach the syringe to the female IN Luer.
- WARNING.** Never inject positive pressure into the IN Luer with the OUT Luer cap in place.
5. Gently inject saline through the catheter until it begins to exit from the OUT Luer.
6. Using a 5 cc or larger syringe, flush the distal, proximal, and medial infusion Luers with sterile saline. Clamp or attach the injection caps to the proximal and medial infusion Luers. Leave the distal Luer uncapped for guidewire passage.

**Caution.** Always prime the catheter infusion Luers before inserting the catheter into the patient.

7. Remove the catheter membrane cover. If there is resistance in removing the membrane cover from the catheter, flush the membrane cover with sterile saline. Inspect the catheter to ensure that air has been purged from the heat exchange membrane. Inspect the catheter for leaks.

**Caution.** Avoid excessive wiping of the coated catheter. Avoid wiping the catheter with dry gauze, as this may damage the catheter coating. Avoid using alcohol, antiseptic solutions, or other solvents to pre-treat the catheter, because this may cause unpredictable changes in the coating, which could affect the device safety and performance.

**WARNING.** Do not cut the catheter to alter length.

### Inserting the catheter

**WARNING.** Use femoral vein approach only.

1. Obtain femoral venous access using standard percutaneous techniques. Access should be maintained with a 0.032" (0.81 mm) guidewire. See Guidewire Instructions for Use.

**WARNING.** Do not attempt to reinsert a partially or completely withdrawn OTN (over the needle) introducer needle from its catheter.

**Caution.** Do not use a guidewire larger than 0.032" (0.81 mm) with the catheter.

2. Holding the guidewire in place, remove the introducer catheter.  
**Caution.** Maintain a firm grip on the guidewire at all times.
3. Enlarge the cutaneous puncture site with the cutting edge of the scalpel positioned away from the guidewire.  
**WARNING.** Do not cut the guidewire. Use the vessel dilator to enlarge the site as required. Do not leave the vessel dilator in place as an indwelling catheter, to minimize the risk of a possible vessel wall perforation.
4. Thread the tip of the catheter over the guidewire. Maintain a sufficiently firm grip on the guidewire during catheter insertion. Grasping the catheter tip near the skin, advance the catheter into the vein. Continue to advance the catheter over the guidewire, placing your fingers just proximal to the balloon.
5. Using centimeter marks on the catheter as positioning reference points, advance the catheter to at least the minimum marker number to ensure the proximal infusion port is in the vessel.
6. Hold the catheter at the desired depth and remove the guidewire. If resistance is encountered when attempting to remove the guidewire after catheter placement, the guidewire may be kinked at the tip of the catheter. If resistance is encountered, withdraw the catheter relative to the guidewire about 2–3 cm and attempt to remove the guidewire. If resistance is encountered again, remove the guidewire and catheter simultaneously.  
**Caution.** Do not apply undue force to the guidewire.
7. Verify that the guidewire is intact upon removal.
8. Check catheter placement by attaching a syringe to the distal infusion Luer and aspirate until a free flow of venous blood is observed. Connect the infusion Luer to the appropriate Luer-Lock line as required. The unused infusion port may be locked through the injection cap using standard hospital protocol. A slide clamp is provided on the tubing to occlude flow through the infusion Luer during line and injection cap changes.  
**Caution.** To minimize risk of damage to the tubing from excessive pressure, the clamp must be opened prior to infusing through the Luer.
- Caution.** Do not clamp or occlude IN or OUT lines. This can cause line blockage and possible failure.
9. Secure and dress the insertion site and catheter temporarily.
10. Verify the catheter tip position by chest x-ray immediately after placement. X-ray examination must show the catheter located in the IVC with the distal end of the catheter parallel to the vena cava wall. If the catheter tip is malpositioned, reposition and reverify.
11. The proximal radiopaque marker indicates the proximal end of the balloon. Ensure that the balloon resides completely in the vessel. If the catheter is malpositioned, reposition and reverify.
12. Secure the catheter to the patient. Use the suture tab side wings as the primary suture site to minimize the risk of catheter migration.
13. The ZOLL suture tab and clip can also be used as an additional attachment point. Ensure that the catheter body is secure and does not slide.  
**Caution.** Use only the ZOLL suture tab and clip provided in the kit. Catheter damage may result if other tabs or clips are used.  
**Caution.** Do not suture directly to the outside diameter of the catheter, to minimize the risk of cutting or damaging the catheter or impeding catheter flow.
14. Dress the puncture site per hospital protocol. Maintain the insertion site with regular meticulous redressing using aseptic technique.

15. Record on the patient's chart the indwelling catheter length, using the centimeter marks on the catheter shaft as reference. Frequent visual reassessment should be made to ensure that the catheter has not moved.
16. Attach a primed Start-Up Kit to the catheter: Connect the male Luer of the Start-Up Kit to the female IN Luer of the catheter (labeled "IN"). Connect the female Luer of the Start-Up Kit to the male OUT Luer of the catheter (labeled "OUT"). White "ZOLL" tags are fitted loosely to the IN and OUT extension tubes to help identify them.  
**Note.** The Start-Up Kit IN and OUT Luers are intended to connect to the catheter IN and OUT Luers only and are not intended to connect to standard Luer Lock syringes. They have ZOLL custom fittings and are orange in color for easy identification.
17. Ensure that a sufficient amount of sterile saline is present at the ends of the Luers to make an air-free connection. Refer to the Coolgard/Thermogard operation manual.  
**WARNING.** Failure to connect the Start-Up Kit correctly to the catheter could result in catheter failure. Do not attach the Start-Up Kit (orange) Luers to the blue, white, or brown Luers.  
**Caution.** Do not attach the Start-Up Kit to the distal port.  
**Caution.** Do not place any stopcocks in line that may be inadvertently shut off. This can cause line blockage and possible failure.
18. Pump saline through the Start-Up Kit and catheter to ensure that all connections are secure and that there is no leaking. Allow any remaining air in the system to be purged out as described in the operation manual.

### Disconnecting the catheter from the console

1. Stop circulation of saline through the catheter.
2. Disconnect the Start-Up Kit from the catheter.
3. To maintain sterile connections, immediately cap off the Luer connectors of both the catheter and Start-Up Kit using sterile Luer caps, or connect the IN and OUT Luers together.

### Reconnecting the catheter to the console

1. Remove the Luer caps from the Luer connectors of the catheter and Start-Up Kit. Discard the Luer caps or disconnect the IN and OUT Luers from each other.
2. Attach the Start-Up Kit to the catheter: Connect the male Luer of the Start-Up Kit to the female IN Luer of the catheter. Connect the female Luer of the Start-Up Kit to the male OUT Luer of the catheter. The Start-Up Kit and catheter IN and OUT Luers are orange in color. Ensure that a sufficient amount of sterile saline is present at the ends of the Luers to make an air-free connection.  
**WARNING.** Failure to connect the Start-Up Kit correctly to the catheter could result in catheter failure.  
**WARNING.** Do not use the IN and OUT Luer fittings for standard central line infusion ports. They are for connection to the console only.
3. The Start-Up Kit IN and OUT Luers are only intended to connect to the catheter IN and OUT Luers. They have ZOLL custom fittings and are orange in color for easy identification.  
**Caution.** Do not place any extra stopcocks in line that may be inadvertently shut off. This can cause line blockage and possible failure.

### Removing the catheter

1. Stop pumping saline through the catheter.
2. Disconnect the Start-Up Kit from the catheter. Uncap or leave uncapped the IN and OUT Luers of the catheter. This allows residual saline within the circuit to be expressed. As the catheter is withdrawn, the balloons are compressed. Saline within the

balloons must be free to pass out of the balloon or the balloon will not deflate, making the catheter difficult to remove.

- Optionally, attach a 20 or 25 cc syringe to the catheter IN Luer. Pull and hold a vacuum for 15 seconds to allow residual saline to be removed from the catheter balloon section prior to removing the catheter.

**Note.** For convenience, a 20 or 25 cc syringe is included with the Start-Up Kit package. Hang it on the saline hook on the console until ready for use. Discard after each patient.

- Place the patient in a supine position. Remove the dressing. Remove the sutures from the suture site.

**WARNING.** Do not place a Luer cap on the OUT Luer.

- Slowly remove the catheter from the patient. As the catheter exits the site, apply pressure with a dressing impermeable to air (e.g. Vaseline gauze).

**WARNING.** Do not move the catheter if resistance is felt. Check to ensure that the IN and OUT Luers of the cooling circuit are NOT capped. If they are capped, uncap them, deflate the balloon, and try removing the catheter again. If resistance is still encountered, an x-ray should be performed to identify the reason for the resistance.

## MRI safety information



MR Conditional

The Quattro Intravascular Heat Exchange Catheter is MR Conditional. A patient with this catheter may be safely scanned under the following conditions. Failure to follow these conditions may result in injury to the patient.

Parameter	Condition
Nominal Values of Static Magnetic Field (T)	1.5 T and 3.0 T
Maximum Spatial Field Gradient (T/m and gauss/cm)	40 T/m (4,000 gauss/cm)
Type of RF Excitation	Circularly Polarized (CP) (i.e., quadrature-driven)
Transmit RF Coil Information	There are no transmit RF coil restrictions. Accordingly, the following may be used: body transmit RF coil and all other RF coil combinations (i.e., body RF coil combined with any receive-only RF coil, transmit/receive head RF coil, transmit/receive knee RF coil, etc.)
Operating Mode of MR System	Normal Operating Mode
Maximum Whole Body Averaged SAR	2-W/kg (Normal Operating Mode)
Limits on Scan Duration	Whole body averaged SAR of 2-W/kg for 60 minutes of continuous RF exposure (i.e., per pulse sequence or back to back sequences/series without breaks)
MR Image Artifact	The presence of this implant produces an imaging artifact. Therefore, carefully select pulse sequence parameters if the implant is located in the area of interest.
<b>WARNING</b>	The ZOLL Coolgard and Thermogard consoles are MR Unsafe and, thus, these consoles are not allowed in the MR system room. Therefore, the catheter must be disconnected from the console prior to moving the patient into the MR system room.

## Guidewire Instructions for Use

**Caution.** Federal law (USA) restricts this device to sale and use by or on the order of a physician.

**Note.** This information applies only to the use of guidewires in the Seldinger technique of catheter placement in the vasculature.

### Warnings

The supplied guidewire is designed for single use only. Do not resterilize or reuse. Do not reinsert, once removed from the patient.

Should resistance occur during insertion or withdrawal, do not continue to move the guidewire. Determine the cause under fluoroscopy and take action as needed.

Use extreme caution when moving a guidewire through a stent. Use of a guidewire in stented vessels creates additional patient risk.

### Cautions

Avoid withdrawing the guidewire through metal needles; the guidewire may shear.

Because of the delicate and fragile nature of guidewires, extra care in handling must be taken. Avoid bending or kinking. Do not use damaged guidewires.

During storage or procedures, avoid coiling the guidewire in less than 8 inch (20.32 cm) diameters, as smaller diameters place unnecessary stress on the guidewire and may cause it to kink. The provided dispenser is the best means of storage and handling of the guidewire.

Sufficient guidewire length must remain exposed to maintain a firm grip on the guidewire at all times.

### Dispenser

Every guidewire is provided in a dispenser package. Remove the guidewire anti-migration clip before dispensing the guidewire. Remove the guidewire protective cap immediately prior to guidewire use. Prepare the guidewire prior to insertion. It is recommended that the dispenser be filled with heparinized solutions (e.g. saline or dextrose) to bathe the guidewire during insertion.

The preformed "J" guidewire will resume its shape when removed from the product dispenser.

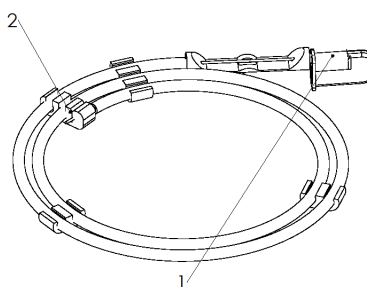

- Guidewire protector cap
- Guidewire anti-migration clip

### Inspection

Inspect the guidewire prior to use and discard if any deformities are present in the guidewire. Guidewire placement should be routinely monitored by x-ray or fluoroscopic procedure.

## Technique

1. Puncture the vessel.
2. Insert the guidewire into the needle hub and gently advance 5-10 cm of the guidewire into the punctured vessel. Navigate the guidewire to the desired position.

**Caution.** Avoid rough or overly vigorous manipulation of the guidewire to prevent damage to the guide or the vessel.

3. Remove the needle from the guidewire.
4. Dilate the tissue and vessel with the dilator using a slight rotary motion.
5. Remove the dilator (the vessel dilator is intended for vascular dilation only).
6. Introduce the catheter by sliding it over the guidewire.
7. Remove the guidewire.

## Quattro catheter

1. IN Luer
2. OUT Luer
3. Infusion ports
4. Distal Luer

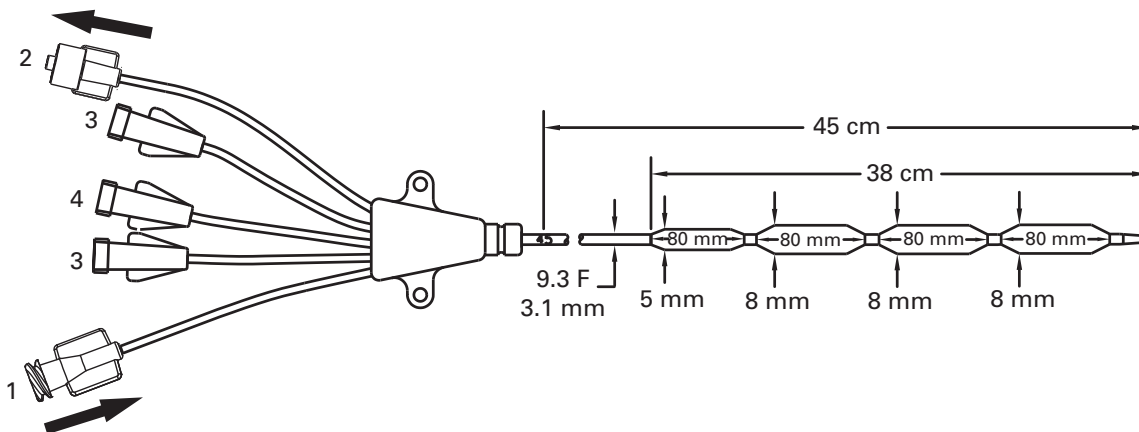

©2022 ZOLL Medical Corporation. All rights reserved. ZOLL and Quattro are trademarks or registered trademarks of ZOLL Medical Corporation and/or ZOLL Circulation Inc. in the United States and/or other countries. All trademarks are the property of their respective owners.

Patent: [www.zoll.com/patents](http://www.zoll.com/patents)

Cat. No. 260100 / 260100B NDC 054365-400-07  
Cat. No. 260103 / 260103B NDC 054365-400-08

## ChloroPrep® Single Swabstick / ChloroPrep® Triple Swabstick

2% w/v chlorhexidine gluconate (CHG) and 70% v/v isopropyl alcohol (IPA)  
Patient Preoperative Skin Preparation

Non-sterile Solution  
Applicator is non-sterile

1.75 ml APPLICATOR / 5.25 ml APPLICATOR

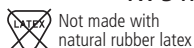

Not made with natural rubber latex

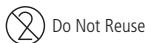

Do Not Reuse

Professional Use Only  
External Use Only

### Drug Facts

#### Active ingredients

Chlorhexidine gluconate 2% w/v ..... Antiseptic  
Isopropyl alcohol 70% v/v ..... Antiseptic

#### Purposes

**Use** for the preparation of the patient's skin prior to surgery or injection. Helps to reduce bacteria that potentially can cause skin infection.

#### Warnings

**For external use only. Flammable, keep away from fire or flame.**

- do not use with electrocautery procedures

#### Allergy Alert

This product may cause a severe allergic reaction. Symptoms may include:

- wheezing/difficulty breathing
  - shock
  - facial swelling
  - hives
  - rash
- If an allergic reaction occurs, stop use and seek medical help right away.

#### Do not use

- on patients allergic to chlorhexidine gluconate or any other ingredient in this product
- for lumbar puncture or in contact with the meninges
- on open skin wounds or as a general skin cleanser

## ChloroPrep® Single Swabstick / ChloroPrep® Triple Swabstick

2% w/v chlorhexidine gluconate (CHG) and 70% v/v isopropyl alcohol (IPA)

### Drug Facts (cont nued)

**When using this product** keep out of eyes, ears, and mouth. May cause serious or permanent injury if permitted to enter and remain. If contact occurs, rinse with cold water right away and contact a doctor.

**Stop use and ask a doctor** if irritation, sensitization, or allergic reaction occurs. These may be signs of a serious condition.

**Keep out of reach of children.** If swallowed, get medical help or contact a Poison Control Center right away.

#### Directions

- use with care in premature infants or infants under 2 months of age. These products may cause irritation or chemical burns.
- maximal treatment area using
  - one single swabstick applicator is approximately 2.5 in. x 2.5 in. (42 cm<sup>2</sup>)
  - three swabsticks sequentially is approximately 5 in. x 5 in. (160 cm<sup>2</sup>)
- tear pouch at side notch to reveal applicator handles. Do not touch foam applicator tip. Place foam flat side down on the treatment area.
- completely wet the treatment area with antiseptic
- dry surgical sites** (e.g., abdomen or arm): use gentle repeated back-and-forth strokes for 30 seconds (when using the triple swabstick applicators, use each swabstick sequentially within the 30 seconds). Allow the area to air dry for approximately 30 seconds. Do not blot or wipe away.
- moist surgical sites** (e.g., inguinal fold): use gentle repeated back-and-forth strokes for 2 minutes (when using the triple swabstick applicators, use each swabstick sequentially within the 2 minutes). Allow the area to air dry for approximately 1 minute. Do not blot or wipe away.
- discard the applicator after a single use along with any portion of the solution not required to cover the prep area. It is not necessary to use the entire amount available.

**Other information** ■ store between 15–30 °C (59–86 °F) ■ avoid freezing and excessive heat above 40 °C (104 °F)

**Inactive ingredient** USP purified water

**Questions?** ■ [www.chloroprep.com](http://www.chloroprep.com) ■ call 1-800-523-0502 (M-F 8 a.m.–5 p.m. CST)

CareFusion, El Paso, TX 79912 · Artwork No. 6-656900 · OXXXXXX · Made in the USA of US and imported parts

#### Precautions for Use

Suresite Window may be used on clinically infected wounds if the following precautions are followed:

- The patient should be under medical/clinical supervision.
- The dressing should be changed daily.
- The patient should be receiving suitable systemic treatment.

Immuno-compromised patients and diabetic patients may require extra supervision. Care should be taken to avoid skin damage from repeated applications on patients with thin or fragile skin.

Sterile. Single use. Do not use contents if package is opened or damaged. Store at room temperature, 59-86°F.

#### Ordering Information:

Item Number	Description	Pkg.
MSC2302	2 3/8" x 2 3/4"	100/bx
MSC2304	4" x 4 3/4"	50/bx

www.medline.com ©2004 Medline Industries, Inc.  
Medline is a registered trademark of Medline Industries, Inc.  
Made In USA for: Medline Industries, Inc.,  
Mundelein, IL 60060 USA 1-800-MEDLINE RID4PC1

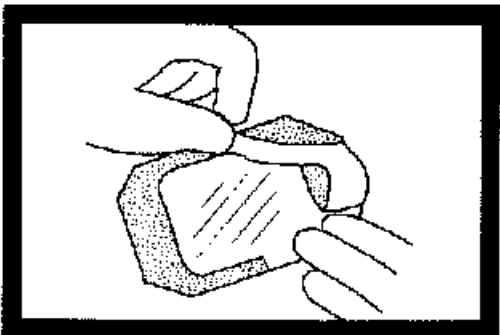
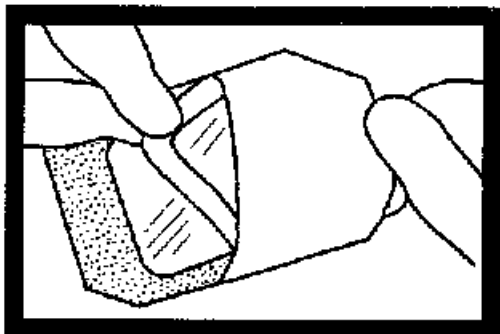

## Suresite® Window Transparent Film Dressing

#### Description

Suresite® Window Transparent Film Dressing consists of a polyurethane film with acrylic adhesive. The dressing is moisture vapor permeable, thus allowing oxygen and moisture vapor to pass through the dressing. When properly applied, Suresite is impermeable to liquids and bacteria.

#### Indications:

Suresite dressings are intended for minor abrasions, skin tears and to help prevent skin breakdown. May also be used on pressure ulcers (stages I & II) with minimal drainage, partial-thickness wounds, clean, closed surgical incisions, first and second degree burns and for autolytic debridement. Also indicated for the management of peripheral and central I.V. catheter sites.

#### Contraindication:

Suresite is contraindicated for use as a primary dressing on moderately to heavily draining wounds.

#### Application:

1. Prepare the site according to facility guidelines. Clip any excess hair at the site. Shaving is not recommended. Allow any skin preparation to dry completely.
2. Peel the liner from the dressing, exposing the adhesive surface.
3. Position the dressing over the site. If securing over an I.V., center the slit portion of the frame over the catheter hub.
4. Gently remove the paper frame, smoothing the dressing down as you pull the frame away.
5. For I.V. catheter sites, seal the dressing around and under the catheter hub.
6. Firmly smooth dressing from the center toward the edges.
7. Date and initial the label and apply to edge of dressing if desired.

#### Removal:

1. Gently grasp the edge and slowly peel the dressing from the skin in the direction of hair growth or grasp one edge of the dressing and gently pull it straight out to stretch and release adhesion.
2. An adhesive solvent can be used to facilitate dressing removal.



# SilvaSorb® Site Dressing

Antimicrobial Silver Percutaneous Site Dressing



## PRODUCT DESCRIPTION

SilvaSorb Site Dressing is a 1" circular pad with a 4 mm center saddle and radial slit. This size and style of dressing is designed to wrap snugly around vascular and non-vascular percutaneous devices such as IV catheters, central venous lines, arterial catheters, external fixator pins and others, providing an antimicrobial environment for up to 7 days.

SilvaSorb Site dressing is composed of super-absorbent polyacrylate and utilizes MicroLattice® patented technology to deliver antimicrobial, ionic silver continuously for up to 7 days. Easy to use, this dressing is self-regulating, requiring no wetting or rewetting to activate. It also provides broad spectrum bioburden control without cytotoxicity and no skin staining. Non-adherent material provides pain-free removal at dressing changes and is transparent to permit insertion-site visualization.

## INDICATIONS FOR USE

SilvaSorb® Silver Antimicrobial is an effective barrier to bacterial penetration and is effective against a broad range of micro-organisms and may help reduce infection in partial and full thickness wounds. Suggested applications include vascular and non-vascular percutaneous sites such as:

- IV Catheters, such as PICC sites
- Central Venous Lines
- Arterial Catheters
- External Fixator pins



## CONTRAINDICATIONS

- Individuals with known sensitivity to silver.



## DIRECTIONS FOR USE

1. Prepare the skin surrounding the site according to facility's protocol. Be sure any skin preparations or cleansers are completely dry before the next step.
2. Remove the SilvaSorb Site dressing from the foil pouch, and peel the dressing from the blue release liner.
3. Gently wrap the round patch snugly around the percutaneous device, placing either side of the dressing down against the skin. The two sides of the radial slit can then be brought back together and overlapped if necessary and should align beneath the device hub such as an IV Catheter. The slit edges must approximate each other to maximize efficacy.
4. Secure the catheter and SilvaSorb Site dressing to the skin with Suresite Transparent Film dressing.
5. Change the SilvaSorb Site dressing as necessary, in accordance with your facility's protocol or at a minimum of every 7 days. Dressing changes may be more frequent on highly exuding sites.
6. To remove the Suresite transparent film dressing, lift one edge and stretch the film laterally to the skin surface, while holding the catheter securely in place. Stretch, lift and peel away the dressing gently. The SilvaSorb Site dressing should lift away along with the film dressing.

## STORAGE INFORMATION

- Dressings are photosensitive and will darken with prolonged exposure to light. This does not affect the performance of the dressing.
- Store at room temperature.
- Do not resterilize.
- Do not use if package is damaged or opened.
- Single patient use only.

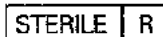

Federal law restricts this device to sale by or on the order of a physician.

## REORDER INFORMATION

Item	Number Description	Pkg.
MSC8310	SilvaSorb Site Dressings 1" circular pad with 4 mm saddle and radial slit	10/bx, 6 bx/cs

www.medline.com SilvaSorb is a registered trademark of AcryMed, Inc., US Patent# 6605751. Patents Pending. Manufactured in USA for: Medline Industries, Inc., Mundelein, IL 60068 USA 1-800-MEDLINE RLD4ACM

L-95

