

ZOLL®

Propaq® MD Operator's Guide



Includes Real CPR Help® and See-Thru CPR®

Use this guide with MP App software version 02.06.07.00 or higher.

The issue date for the Propaq MD Operator's Guide (**REF 9650-0806-05 Rev. B**) is **February, 2016**.

Copyright © 2016 ZOLL Medical Corporation. All rights reserved. AutoPulse, AED Plus, AED Pro, ExpressShock, CPR-D-padz, pedi-padz, OneStep, Real CPR Help, Rectilinear Biphasic, RescueNet, See-Thru CPR, stat-padz, SurePower, and ZOLL are trademarks or registered trademarks of ZOLL Medical Corporation in the United States and/or other countries. All other trademarks are the property of their respective owners.

Masimo, Rainbow, SET, SpCO, SpMet, SpHb, SpOC, and PVI are trademarks or registered trademarks of Masimo Corporation in the United States and/or other countries.

Propaq is a registered trademark of Welch Allyn Inc.

Oridion Microstream FilterLine[®] and Smart CapnoLine[®] are registered trademarks of Medtronic plc.



ZOLL Medical Corporation

269 Mill Road
Chelmsford, MA USA
01824-4105



ZOLL International Holding B.V.

Newtonweg 18
6662 PV ELST
The Netherlands



0123

Table of Contents

Chapter 1 General Information

Product Description	1-1
Propaq MD Optional Features	1-2
How to Use This Manual.....	1-3
Operator's Guide Updates	1-3
Unpacking.....	1-3
Symbols Used on the Equipment	1-3
Conventions.....	1-7
Propaq MD Indications for Use	1-7
Manual Defibrillation	1-8
Semiautomatic Operation (AED)	1-8
ECG Monitoring	1-9
CPR Monitoring	1-9
External Transcutaneous Pacing	1-9
Non-Invasive Blood Pressure Monitoring	1-9
Temperature Monitoring	1-9
SpO2 Monitoring	1-10
Respiration Monitoring	1-10
CO2 Monitoring	1-10
Invasive Pressure Monitoring	1-10
12-Lead Analysis	1-10
Propaq MD Product Functions.....	1-11
Defibrillator Function	1-11
Defibrillator Output Energy	1-11
External Pacemaker	1-11
ECG Monitoring	1-11
Electrodes	1-12
Batteries	1-13
Ready For Use (RFU) Indicator	1-14
Safety Considerations.....	1-15
Warnings.....	1-15
General	1-15
ECG Monitoring	1-17
Defibrillation	1-18
Pacing	1-19
CPR	1-20
Pulse Oximeter	1-20
Noninvasive Blood Pressure	1-21
IBP	1-21
CO2	1-22
Respiration	1-22
Ferromagnetic Equipment	1-22

Battery	1-22
Operator Safety	1-23
Patient Safety	1-24
Cautions.....	1-25
Restarting the Defibrillator	1-26
FDA Tracking Requirements.....	1-26
Notification of Adverse Events	1-27
Software License	1-27
Service.....	1-28
The ZOLL Serial Number.....	1-29

Chapter 2 Product Overview

Defibrillator Controls and Indicators.....	2-1
The Front Panel	2-2
Display Screen	2-5
Battery Status and Auxiliary Power Indicators	2-6
Patient Cables and Connectors	2-7
Propaq MD with AutoPulse Plus (optional)	2-11
External Paddles	2-13
Auxiliary Power Adapter	2-16
Navigating the Display Screen.....	2-17
Quick Access Keys	2-17
Navigation Keys	2-20
Display Brightness	2-20
Common Tasks	2-21
Setting the Date and Time	2-21
Changing the Display Brightness	2-22
Replacing a Battery Pack on the Propaq MD	2-23
Using Treatment Buttons	2-24

Chapter 3 Monitoring Overview

Propaq MD Monitoring Functions	3-1
ECG	3-2
Heart Rate	3-2
Respiration Rate	3-2
Temperature	3-2
Invasive Pressures (IBP)	3-2
Non-Invasive Blood Pressure (NIBP)	3-2
Capnography (CO ₂)	3-3
Pulse Oximetry (SpO ₂)	3-3
Monitoring Display Options.....	3-4
Configuring the Waveform Display	3-7

Chapter 4 Trends

Displaying the Trends Status Window	4-2
Printing Trend Information	4-3
Printing Trend Summary	4-3
Printing The 10 Most Recent Trend Snapshots	4-3
Printing an Individual Trend Snapshot	4-3
Printing Specific Trend Snapshots	4-3
Changing the Trends Status Window Display	4-4
Continuous Waveform Recording	4-5

Chapter 5 Alarms

Visual Alarm Indicators	5-2
Audible Alarm Indicators	5-2
Alarm Indicator Self-Test.....	5-2
Patient Alarm Display.....	5-3
Life Threatening Rhythm Alarms.....	5-3
Equipment Alert Display.....	5-4
Responding to Active Alarms -- Silencing the Alarm	5-5
Re-enabling an Alarm	5-5
Latching Alarms	5-5
Pausing (Suspending) Alarms	5-6
Alarm Reminders	5-6
Alarm Options	5-7
Selecting Default Alarm Limits	5-7
Setting Alarm Limits Relative to the Patient -- Stat Set Option	5-8

Chapter 6 Monitoring ECG

ECG Monitoring Setup.....	6-3
Preparing the Patient for Electrode Application	6-3
Applying Electrodes to the Patient	6-4
Connecting the ECG Cable To the Propaq MD Unit	6-6
Selecting ECG Waveforms for Display	6-6
Selecting the Waveform Trace Size	6-8
ECG Monitoring and Pacemakers	6-9
ECG System Messages.....	6-10

Chapter 7 Monitoring Respiration (Resp) and Heart Rate (HR)

Respiration/Breath Rate Meter	7-2
Using Impedance Pneumography to Measure Respiration	7-2
Configuring Respiration (RR/BR) Alarms and Settings.....	7-3
Enabling/Disabling RR/BR Alarms and Setting Alarm Limits	7-3
Using the Resp Parameter Control Panel	7-4
Heart Rate Meter	7-5
Configuring Heart Rate (HR) Meter Alarms	7-5
Enabling/Disabling HR Alarms and Setting Alarm Limits	7-5
Life Threatening Rhythm Alarms	7-6
Using the Heart Rate Parameter Control Panel	7-8
RESP System Message.....	7-8

Chapter 8 Monitoring Non-Invasive Blood Pressure (NIBP)

How does NIBP Work?	8-3
The NIBP Numeric Display	8-4
NIBP Setup and Use.....	8-4
Selecting the NIBP Cuff	8-5
Connecting the NIBP Cuff.....	8-6
Applying the Cuff to the Patient	8-9
Ensuring Correct Cuff Inflation Settings.....	8-10
Configuring NIBP Alarms and Settings	8-11
Enabling/Disabling NIBP Alarms and Setting Alarm Limits	8-11
Using the NIBP Parameter Control Panel	8-14
NIBP System Messages	8-16

Chapter 9 Monitoring CO₂

Overview	9-1
CO ₂ Monitoring Setup and Use	9-3
Selecting the CO ₂ Sampling Line	9-3
Connecting the CO ₂ Sampling Lines	9-4
Applying a FilterLine Set	9-5
Applying a Smart CapnoLine Nasal or Nasal/Oral Cannula	9-6
Measuring CO ₂	9-7
Setting CO ₂ and Respiration Rate Alarms	9-8
Enabling/Disabling Alarms and Setting CO ₂ Alarm Limits	9-8
Using the CO ₂ Parameter Control Panel	9-10
System Messages	9-11
Patents.....	9-12

Chapter 10 Pulse CO-Oximetry (SpO2)

Warnings -- SpO2 General	10-3
Cautions.....	10-5
SpO2 Setup and Use.....	10-6
Selecting the SpO2 Sensor	10-6
Applying the SpO2 Sensor	10-6
Applying a Two-Piece Single-Use Sensor/Cable	10-7
Applying a Reusable Sensor/Cable	10-9
Cleaning and Reuse of Sensors	10-9
Connecting the SpO2 Sensor	10-10
Displaying Measurements	10-10
Enabling/Disabling SpO2 Alarms and Setting Alarm Limits	10-11
Setting Upper and Lower SpO2 Alarm Limits	10-11
Setting Upper and Lower SpCO and SpMet Alarm Limits	10-12
Setting Upper and Lower SpHb Alarm Limits	10-12
Setting Upper and Lower SpOC Alarm Limits	10-13
Setting Upper and Lower PVI Alarm Limits	10-13
Setting Upper and Lower PI Alarm Limits	10-13
Using the SpO2 Parameter Control Panel.....	10-14
SpCO and SpMet, and SpHb, SpOC, PVI and PI Monitoring	10-14
Specifying the SpO2 Averaging Time	10-14
Selecting the SpO2 Sensitivity	10-14
Selecting SpHb Venous Mode	10-15
Specifying the SpHb Averaging Time	10-15
Selecting the Heart Rate/ Pulse Rate (HR/PR) Tone	10-15
SpO2 System Messages	10-15
Functional Testers and Patient Simulators.....	10-16
Patents.....	10-16

Chapter 11 Monitoring Invasive Pressures (IBP)

Invasive Pressure Transducers	11-1
IBP Setup.....	11-2
Attaching the Invasive Pressure Transducer	11-3
Zeroing the Transducer.....	11-4
Rezeroing a Transducer	11-5
Displaying IBP Measurements.....	11-5
Conditions Affecting IBP Measurements	11-5
Enabling/Disabling IBP Alarms and Setting Alarm Limits.....	11-6
Setting Upper and Lower Systolic (SYS) Alarm Limits	11-6
Setting Upper and Lower Diastolic (DIA) Alarm Limits	11-7
Setting Upper and Lower Mean Arterial Pressure (MEAN) Alarm Limits	11-7
Setting IBP Source Label	11-8
IBP System Messages.....	11-9

Chapter 12 Monitoring Temperature

Temperature Monitoring Setup	12-1
Selecting and Applying Temperature Probes	12-1
Connecting the Temperature Probe	12-2
Displaying Temperature	12-2
Enabling/Disabling Temperature Alarms and Setting Alarm Limits	12-3
Setting Upper and Lower Temperature Alarm Limits	12-3
Setting Upper and Lower Temperature Alarm Limits	12-4
Selecting the Temperature Label	12-4
Temperature System Messages	12-5

Chapter 13 Automated External Defibrillator (AED)

AED Operation	13-2
Determine Patient Condition Following Medical Protocols	13-2
Begin CPR Following Medical Protocols	13-2
Prepare Patient	13-3
1 Turn on unit	13-4
2 Analyze	13-5
3 Press SHOCK	13-7
ExpressShock	13-8
The Shock Conversion Estimator	13-8
Operating Messages	13-8
Audio and Display Messages	13-8
Switching to Manual Mode Operation	13-11

Chapter 14 12-Lead ECG Interpretive Analysis

Entering Patient Information	14-3
Entering the Patient Name and ID	14-4
Entering Patient Age and Gender	14-4
12-Lead ECG Monitoring Setup	14-5
Preparing the Patient for Electrode Application	14-5
Applying Electrodes to the Patient	14-6
Connecting the 12-Lead Cable	14-8
Observing the 12-Lead Waveform Traces	14-8
12-Lead Interpretive Analysis	14-9
Fault Conditions Affecting 12-Lead Interpretive Analysis	14-12
Printing 12-Lead Waveform Traces	14-13
12-Lead Print and Display Options	14-15
Selecting 12-Lead Acquire	14-15
Specifying the Number of 12-Lead Print Copies	14-15
Specifying the 12-Lead Print Format	14-15
Printing 10 Seconds of the Lead II Waveform Trace	14-16
Specifying the 12-Lead Frequency Response	14-16
Enabling 12-Lead Analysis	14-16

Chapter 15 Manual Defibrillation

Emergency Defibrillation Procedure with Paddles	15-1
Determine the Patient's Condition Following Local Medical Protocols	15-2
Begin CPR Following Local Medical Protocols	15-2
Turn On Unit	15-2
1 Select Energy Level	15-2
2 Charge Defibrillator	15-4
3 Deliver Shock	15-6
Emergency Defibrillation Procedure with Hands-Free Therapy Electrodes	15-7
Determine the Patient's Condition Following Local Medical Protocols	15-7
Begin CPR Following Medical Protocols	15-7
Prepare Patient	15-7
Turn On Unit	15-8
1 Select Energy Level	15-8
2 Charge Defibrillator	15-9
3 Deliver Shock	15-10
Internal Paddles.....	15-10
Verification Prior to Use	15-11
Synchronized Cardioversion.....	15-12
Synchronized Cardioversion Procedure	15-13
Determine the Patient's Condition and Provide Care Following Local Medical Protocols	15-13
Prepare Patient	15-13
Turn On Unit	15-13
Press the Sync Button	15-13
1 Select Energy Level	15-14
2 Charge Defibrillator	15-14
3 Deliver Shock	15-15

Chapter 16 Advisory Defibrillation

Advisory Defibrillation Procedure.....	16-2
Determine the Patient's Condition Following Local Medical Protocols	16-2
Begin CPR Following Local Medical Protocols	16-2
Prepare Patient	16-2
1 Turn on unit	16-3
2 Press ANALYZE	16-4
3 Press SHOCK button	16-5

Chapter 17 Analysis/CPR Protocol Defibrillation

Analysis/CPR Protocol Defibrillation Procedure	17-2
Determine the Patient's Condition Following Local Medical Protocols	17-2
Begin CPR Following Local Medical Protocols	17-2
Prepare Patient	17-2
1 Turn on unit	17-3
2 Press ANALYZE	17-4

3 Press SHOCK button	17-5
ExpressShock	17-6
The Shock Conversion Estimator	17-6

Chapter 18 External Pacing

External Pacing.....	18-2
Pacer Modes	18-2
Pacing in Demand Mode	18-2
Determine Patient Condition and Provide Care Following Local Medical Protocols.	18-2
Prepare the Patient	18-2
1 Turn On Unit	18-2
2 Apply ECG Electrodes/Hands-Free Therapy Electrodes	18-3
3 Press Pacer button	18-3
4 Set Mode	18-4
5 Set Pacer Rate	18-4
6 Turn On Pacer	18-4
7 Set Pacer Output	18-4
8 Determine Capture	18-5
9 Determine Optimum Threshold	18-5
Pacing in Fixed Mode	18-6
1 Turn On Unit	18-6
2 Apply ECG Electrodes/Hands-Free Therapy Electrodes	18-6
3 Press Pacer button	18-7
4 Set Mode	18-7
5 Set Pacer Rate	18-7
6 Turn On Pacer	18-7
7 Set Pacer Output	18-8
8 Determine Capture	18-8
9 Determine Optimum Threshold	18-8
Pediatric Pacing	18-9

Chapter 19 Real CPR Help

CPR Voice Prompts (Adult Only)	19-3
CPR Metronome	19-3
Constant Metronome Enabled	19-3
Constant Metronome Disabled	19-4
FULLY RELEASE Prompt	19-4
CPR Dashboard.....	19-5
CPR Rate and Depth Measurements	19-5
CPR Release Indicator (Adult Only)	19-6
Chest Compression Indicator (Adult Only)	19-6
CPR Countdown Timer	19-6
CPR Idle Time Display	19-7
CPR Compression Bar Graph (Adult Only)	19-7

Chapter 20 See-Thru CPR

Using See-Thru CPR	20-2
Examples	20-3

Chapter 21 Patient Data

Storing Data	21-1
Log Capacity Indicator	21-2
Capturing a Data Snapshot	21-2
Reviewing and printing snapshots	21-2
Treatment Summary Report	21-3
Printing Treatment Summary Report	21-3
Transferring Data to a USB Device	21-4
Clearing the Log	21-5

Chapter 22 Communications

The Wireless Icon	22-2
The Wireless Menu	22-4
Selecting a Pre-Configured Access Point Profile	22-5
Creating a Temporary Access Point Profile	22-6
Bluetooth Device Pairing	22-10
Sending a 12-Lead Report	22-13
Sending Disclosure Logs	22-14
Supervisor Communications Menu	22-15
Overview	22-15
Accessing the Communications Menu	22-15
WiFi Access Point Profiles	22-17
Setting up Cellular Communications	22-24
Setting up an Ethernet Connection	22-29
Configuring 12-Lead Report Transmissions	22-30
Configuring Disclosure Log Transmissions	22-31
Configuring Clock Synchronization	22-32
Communications System Messages	22-34
Transmission Status Icons	22-35

Chapter 23 Printing

Printing Patient Data	23-1
Printer Setup	23-2
Automatic Prints	23-2
Printing Waveforms	23-2
Printing Reports	23-3
Printing Trends	23-4

Chapter 24 Maintenance

Daily/Shift Check Procedure	24-2
Inspection	24-2
Defibrillator/Pacing Test with Hands-Free Therapy Electrodes.....	24-3
Defibrillator Testing with External Paddles.....	24-5
Recommended Minimum Preventive Maintenance Schedule	24-6
Annually	24-6
Guidelines for Maintaining Peak Battery Performance	24-6
Cleaning instructions	24-7
Cleaning the Propaq MD unit	24-7
Cleaning the NIBP Blood Pressure Cuff	24-7
Cleaning SpO2 Sensors	24-8
Cleaning Cables and Accessories	24-8
Loading Recorder Paper	24-8
Cleaning the Print Head	24-9

Appendix A Specifications

Defibrillator.....	A-2
Monitor/Display	A-14
Impedance Pneumography.....	A-15
Alarms.....	A-16
Recorder	A-17
Battery	A-17
General	A-18
Pacer	A-19
CO2	A-19
Pulse Oximeter	A-20
Non-Invasive Blood Pressure	A-22
Invasive Pressures	A-23
Temperature.....	A-24
Clinical Trial Results for the Biphasic Waveform	A-25
Randomized Multicenter Clinical Trial for Defibrillation of Ventricular Fibrillation (VF) and Ventricular Tachycardia (VT)	A-25
Randomized Multi-Center Clinical trial for Cardioversion of Atrial Fibrillation (AF)	A-26
Synchronized Cardioversion of Atrial Fibrillation	A-28
Electromagnetic Compatibility Guidance and Manufacturer's Declaration	A-29
Electromagnetic Immunity (IEC 60601-1-2)	A-30
Electromagnetic Immunity: Life-Supporting Functions	A-31
Electromagnetic Immunity: Non Life-Supporting Functions	A-32
ECG Analysis Algorithm Accuracy	A-35
Clinical Performance Results	A-35
Shock Conversion Estimator	A-37
Wireless Output Guidance and Manufacturer's Declaration.....	A-39

RF Transmission Emitted (IEC 60601-1-2)	A-39
FCC Notice	A-39
Canada, Industry Canada (IC) Notices	A-39

Appendix B Accessories

Chapter 1

General Information

Product Description

The ZOLL® Propaq® MD unit is an easy-to-use portable defibrillator that combines defibrillation and external pacing with the following monitoring capabilities: ECG, CO-Oximeter, Non-invasive Blood Pressure, IBP, CO₂, Temperature, and Respiration. It has been designed for all resuscitation situations and its rugged, compact, lightweight design makes it ideal for transport situations. It is powered by auxiliary power and an easily replaced battery pack that is quickly recharged in the device when it is connected to auxiliary power. In addition, the unit's battery may be recharged and tested using a ZOLL *SurePower™ Battery Charger Station*.

Note: The Propaq MD has defibrillation and pacing functionality, but some of the monitoring functions are optional features. See the complete list of options in Fig. 1-1. All features are included in this manual, but only purchased features will be available on your unit.

The product is designed for use in hospital, EMS, and rugged military environments. The device is a versatile automated external defibrillator with manual capabilities and may be configured to operate in Manual, Advisory or Semiautomatic modes. It can be configured to start up in Semiautomatic (AED) mode or manual mode.

When operating in manual configuration, the device operates as a conventional defibrillator where the device's charging and discharging is fully controlled by the operator. In Advisory and AED modes, some features of the device are automated and a sophisticated detection algorithm is used to identify ventricular fibrillation and determine the appropriateness of defibrillator shock delivery. Units may be configured to automatically charge, analyze, recharge, and prompt the operator to "PRESS SHOCK", depending on local protocols. The unit is switched from AED mode to Manual mode for ACLS use by pressing the appropriate key on the front panel.

The Propaq MD unit assists caregivers during cardiopulmonary resuscitation (CPR) by evaluating the rate and depth of chest compressions and providing feedback to the rescuer. Real CPR Help[®] requires the use of ZOLL OneStep[™] CPR electrodes, OneStep[™] Complete electrodes, or CPR-D-padz[®]. When using these pads, the displayed ECG waveforms can be adaptively filtered, using the See-Thru CPR[®] feature, to reduce the artifact caused by chest compressions.

The unit has a large colorful LCD display of numerics and waveform data that provides easy visibility from across the room and at any angle. ECG, plethysmograph, and respiration waveform traces can be displayed simultaneously, giving easy access to all patient monitoring data at once. The display screen is configurable, so you can choose the best visual layout to fit your monitoring needs. The Propaq MD includes a transcutaneous pacemaker consisting of a pulse generator and ECG sensing circuitry. Pacing supports both demand and fixed noninvasive pacing for adult patients and adolescent, child, and infant pediatric patients.

The Propaq MD has a patient data review and collection system that allows you to view, store, and transfer patient data. The Propaq MD unit contains a printer and USB port, which you can use to print the data and transfer it to a PC.

The Propaq MD unit can send data through a wireless connection to remote locations. The unit can send 12-lead report snapshots (including trend data) or Disclosure Logs to a recipient via a ZOLL server. In addition, full disclosure cases, which also contain trend data, can be automatically retrieved from the Propaq MD unit using ZOLL RescueNet[®] or ePCR software.

Propaq MD Optional Features

The following features are optional in the Propaq MD unit.

Note: All features are included in this manual, but only purchased features will be available on your unit.

Figure 1-1 Propaq MD Optional Features

Optional Feature
12-Lead ECG with Interpretation
SpO ₂ (Masimo [®]) with SpCO [®] and SpMet [®]
SpHb [®] (Masimo [®]) with SpOC [™] , PVI [®] and PI
NIBP (with Smartcuf [®] and SureBP [™])
EtCO ₂ (Oridion [®] Microstream [®])
Temperature (2 Channels)
Invasive Pressures (3 Channels)
Advanced CPR Help
Pacing
Wireless communications

How to Use This Manual

The Propaq MD Operator's Guide provides information operators need for the safe and effective use and care of the Propaq MD product. It is important that all persons using this device read and understand all the information contained within.

Please thoroughly read the safety considerations and warnings section.

Procedures for daily checkout and unit care are located in the Chapter 24, "Maintenance".

Operator's Guide Updates

An issue or revision date for this manual is shown on the front cover. If more than three years have elapsed since this date, contact ZOLL Medical Corporation to determine if additional product information updates are available.

All users should carefully review each manual update to understand its significance and then file it in its appropriate section within this manual for subsequent reference.






Product documentation is available through the ZOLL website at www.zoll.com. From the Products menu, choose Product Manuals.








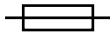






Unpacking















Carefully inspect each container for damage. If the shipping container or cushion material is damaged, keep it until the contents have been checked for completeness and the instrument has been checked for mechanical and electrical integrity. If the contents are incomplete, if there is mechanical damage, or if the defibrillator does not pass its electrical self-test, U.S.A. customers should call ZOLL Medical Corporation (1-800-348-9011). Customers outside of the U.S.A. should contact the nearest ZOLL authorized representative. If the shipping container is damaged, also notify the carrier.








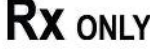





Symbols Used on the Equipment

Any or all of the following symbols may be used in this manual or on this equipment:

Symbol	Description
	Dangerous voltage.
	Attention, consult accompanying documents.
	Fragile, handle with care.
	Keep dry.
	This end up.

Symbol	Description
	Temperature limitation.
	Conformité Européenne Complies with medical device directive 93/42/EEC.
	Type B patient connection.
	Type BF patient connection.
	Type CF patient connection.
	Defibrillator-proof type BF patient connection.
	Defibrillator-proof type CF patient connection.
	Fusible link.
	Equipotentiality.
	Alternating current (ac).
	Direct current (dc).
	Auxiliary power adapter operation.
	Caution, high voltage.
	Earth (ground).

Symbol	Description
	Negative input terminal.
	Positive input terminal.
	Power On/Off
	Protective earth (ground).
	Contains lithium. Recycle or dispose of properly.
	Keep away from open flame and high heat.
	Do not open, disassemble, or intentionally damage.
	Do not crush.
	Do not discard in trash. Recycle or dispose of properly.
	Return to a collection site intended for waste electrical and electronic equipment (WEEE). Do not dispose of in unsorted trash.
	Date of manufacture.
	Use by.
	Latex-free.
	Do not reuse.

Symbol	Description
	Do not fold.
	Not sterile.
	Manufacturer.
	Authorized representative in the European Community.
	Serial Number.
	Catalogue number.
	Consult instructions for use.
	Prescription only.
	Alarm audio is currently off.
	Alarm audio is currently paused.
	Pacer indicator disabled.
	Battery charging status.
	Do not use device, cables, or probes in an MRI environment.

Conventions

This guide uses the following conventions:

Within text, the names and labels for physical buttons and softkeys appear in **boldface** type (for example, “Press the **Charge** button or press the **Pacer** button”).

This guide uses uppercase italics for audible prompts and for text messages displayed on the screen (for example, *LEAD FAULT*).

Warning! **Warning statements alert you to conditions or actions that can result in personal injury or death.**

Caution Caution statements alert you to conditions or actions that can result in damage to the unit.

Propaq MD Indications for Use

The Propaq MD is intended for use by trained medical personnel who are familiar with basic monitoring, vital sign assessment, emergency cardiac care, and the use of the Propaq MD. The Propaq MD is also intended for use by (or on the order of) physicians at the scene of an emergency or in a hospital emergency room, intensive care unit, cardiac care unit, or other similar areas of a hospital. The usage may be in an ambulance or at the scene of an emergency. It is also intended to be used during the transport of patients. The Propaq MD will be used primarily on patients experiencing symptoms of cardiac arrest or in post trauma situation. It may also be used whenever it is required to monitor any of those functions that are included (as options) in the device. The Propaq MD unit can be used on pediatric patients (as described in the following table) and on adult patients (21 years of age or older) with and without heart dysfunction.

Pediatric Patient Subpopulation	Approximate Age Range
Newborn (neonate)	Birth to 1 month of age.
Infant	1 month to 2 years of age.
Child	2 to 12 years of age.
Adolescent	12 to 21 years of age.

When the pediatric patient is less than 8 years of age or weighs less than 55 lbs. (25 kg.), use ZOLL pediatric defibrillation electrodes. Do not delay therapy to determine the patient’s exact age or weight.

Manual Defibrillation

Use of the Propaq MD in the manual mode for external and internal defibrillation is indicated on victims of cardiac arrest where there is apparent lack of circulation as indicated by:

- Unconsciousness.
- Absence of breathing.
- Absence of pulse.

This product should be used only by qualified medical personnel for converting ventricular fibrillation and rapid ventricular tachycardia to sinus rhythm or other cardiac rhythms capable of producing hemodynamically significant heart beats.

The unit can also be used for synchronized cardioversion of certain atrial or ventricular arrhythmias. Qualified medical personnel must decide when synchronized cardioversion is appropriate.

Note: Synchronized cardioversion is disabled when the Propaq MD unit is connected to the AutoPulse Plus® and the AutoPulse Plus is compressing.

The patient population will range from newborn (neonate) to adult.

Semiautomatic Operation (AED)

Propaq MD products are designed for use by emergency care personnel who have completed training and certification requirements applicable to the use of a defibrillator where the device operator controls delivery of shocks to the patient.

They are specifically designed for use in early defibrillation programs where the delivery of a defibrillator shock during resuscitation involving CPR, transportation, and definitive care are incorporated into a medically-approved patient care protocol.

Use of the Propaq MD in the Semiautomatic mode for defibrillation is indicated on victims of cardiac arrest where there is apparent lack of circulation as indicated by:

- Unconsciousness.
- Absence of breathing.
- Absence of pulse.

Specifications for the ECG rhythm analysis function are provided in the section “ECG Analysis Algorithm Accuracy” on page A-35.

When the patient is less than 8 years of age or weighs less than 55 lbs. (25 Kg), you must use ZOLL pediatric defibrillation electrodes. Do not delay therapy to determine patient’s exact age or weight.

ECG Monitoring

The Propaq MD is intended for use to monitor and/or record 3-, 5-, or 12-lead ECG waveform and heart rate, and to alarm when heart rate is above or below limits set by the operator. The patient population will range from newborn (neonate) to adult, with and without heart dysfunction.

CPR Monitoring

The CPR monitoring function provides visual and audio feedback designed to encourage rescuers to perform chest compressions at the AHA/ERC recommended rate of 100 compressions per minute. Voice and visual prompts encourage a minimum compression depth of at least 1.5 (3.8 cm) or 2.0 inches (5.0 cm), depending on the configuration, for adult patients.

External Transcutaneous Pacing

This product can be used for temporary external cardiac pacing in conscious or unconscious patients as an alternative to endocardial stimulation.

The purposes of pacing include:

- Resuscitation from standstill or bradycardia of any etiology:
- As a standby when standstill or bradycardia might be expected:
- Suppression of tachycardia.
- Pediatric pacing.

Non-Invasive Blood Pressure Monitoring

The Propaq MD NIBP option is intended for use to make non-invasive measurements of arterial pressure and heart rate, and to alarm if either parameter is outside of the limits set by the user. Measurements are made using an inflatable cuff on the patient's arm or leg. The patient population will range from newborn (neonate) to adult.

Temperature Monitoring

The Propaq MD is intended for use to make continuous temperature measurements of rectal, esophageal, or surface temperatures, and to alarm if the temperature is outside of the limits set by the user. The patient population will range from newborn (neonate) to adult.

SpO₂ Monitoring

The Propaq MD pulse CO-oximeter with Masimo Rainbow® SET® technology is intended for use for continuous noninvasive monitoring of functional oxygen saturation of arterial hemoglobin (SpO₂), pulse rate, carboxyhemoglobin saturation (SpCO), and/or methemoglobin saturation (SpMet), total hemoglobin (SpHb), oxygen content (SpOC), pleth variability index (PVI), and/or perfusion index (PI). The pulse CO-oximeter and accessories are indicated for use on adult, pediatric, and neonatal patients during both no motion and motion conditions, and for patients who are well or poorly perfused, in hospitals, hospital-type facilities, or in mobile environments.

Respiration Monitoring

The Propaq MD is intended for use to continuously monitor respiration rate and to alarm if the rate falls outside of the range set by the operator. Because the measurement method actually measures respiratory effort, apnea episodes with continued respiratory effort (such as obstructive apnea) may not be detected. It is not intended to be used as an apnea monitor. The patient population will range from newborn (neonate) to adult.

CO₂ Monitoring

The Propaq MD is intended for use to make continuous noninvasive measurement and monitoring of carbon dioxide concentration of the expired and inspired breath and breath rate. The patient population will range from newborn (neonate) to adult.

Invasive Pressure Monitoring

The Propaq MD is intended for use to display and make continuous invasive pressure measurements from any compatible pressure transducer. The primary intended uses are arterial blood pressure, central venous pressure and intracranial pressure monitoring. Any contraindications of the particular transducer selected by the user shall apply. The patient population will range from newborn (neonate) to adult.

12-Lead Analysis

The 12-lead ECG Analysis is intended for use in acquiring, analyzing and reporting ECG data, and to provide interpretation of the data for consideration by caregivers. The interpretations of ECG data offered by the device are only significant when used in conjunction with caregiver overread as well as consideration of all other relevant patient data. The 12-lead ECG Analysis is intended for use on adults (> 18 years of age).

Propaq MD Product Functions

Defibrillator Function

The Propaq MD contains a direct current (dc) defibrillator capable of delivering up to 200 joules. It may be used in synchronized mode to perform synchronized cardioversion using the patient's R-wave as a timing reference. The unit uses paddles or disposable, pregelled electrodes for defibrillation.

Defibrillator Output Energy

Propaq MD defibrillators can deliver biphasic energy from 1 joule to 200 joules. The energy delivered through the chest wall, however, is determined by the patient's transthoracic impedance. An adequate amount of electrolyte gel must be applied to the paddles and a force of 10 to 12 kilograms (22 to 26.4 pounds) must be applied to each paddle in order to minimize this impedance. If hands-free therapy electrodes are used, make sure that they are properly applied. (Refer to the instructions on the electrode package).

External Pacemaker

Propaq MD defibrillators include a transcutaneous pacemaker consisting of a pulse generator and ECG-sensing circuitry. Noninvasive transcutaneous pacing (NTP) is an established and proven technique. This therapy is easily and rapidly applied in both emergency and nonemergency situations when temporary cardiac stimulation is indicated.

The output current of the pacemaker is continuously variable from 10 to 140 mA (the output current is 0 mA when paused). The rate is continuously variable from 30 to 180 pulses per minute (ppm), by increments of 5 ppm (10 bpm when greater than 100 ppm).

The pacing output pulse is delivered to the heart via ZOLL hands-free defibrillation/pacing electrodes placed on the patient's back and the precordium.

Proper operation of the device, together with correct electrode placement, is critical to obtaining optimal results. Every operator must be thoroughly familiar with these operating instructions.

ECG Monitoring

The patient's ECG is monitored by connecting the patient to the unit via a 3-, 5-, or 12-lead patient cable or hands-free therapy electrodes. The ECG waveform is presented on the display along with the following information:

- averaged heart rate, derived by measuring R to R intervals
- lead selection - I, II, III, aVR, aVL, aVF, V1, V2, V3, V4, V5, V6 (with ECG cable), PADDLES, or PADS (APLS if connected to AutoPulse® Plus).
- ECG size - 0.125, 0.25, 0.50, 1.0, 2.0, 4.0 cm/mV, AUTO
- status messages

The ECG bandwidth is user selectable.

Electrodes

The Propaq MD units will defibrillate, cardiovert, and monitor ECG using hands-free therapy electrodes. The Propaq MD unit will pace using ZOLL hands-free therapy electrodes.

Energy Select, Charge and Shock controls are located on the paddles and front panel. When using hands-free therapy electrodes, you must use the controls on the front panel of the unit. To switch between paddles and hands-free therapy electrodes, remove the multifunction cable (MFC or OneStep) from the apex paddle and connect the hands-free therapy electrodes to the cable.

You should always check the expiration date on the electrode packaging. Do not use expired electrodes, which might result in false patient impedance readings and affect the level of delivered energy, or cause burns.



This symbol on the electrode package is accompanied by the expiration date.

For stat-padz® II, this symbol does not appear; the expiration date appears on the lower right corner of the label, below the lot number.

Note: ZOLL electrodes contain no hazardous materials and may be disposed of in general trash unless contaminated with pathogens. Use appropriate precautions when disposing of contaminated electrodes.

When the patient is less than 8 years old or weighs less than 55 lb. (25 kg), use ZOLL OneStep Pediatric defibrillation electrodes. Do not delay therapy to determine the patient's exact age or weight.

Batteries

Propaq MD models use an easily replaced rechargeable lithium-ion battery pack (the *SurePower II* Battery Pack). A new, fully charged battery pack typically delivers more than 6 hours of ECG monitoring. Use of other functions (such as the defibrillator, printer, or pacemaker) reduces this time.

When a *LOW BATTERY* icon appears on the display and the unit emits three beeps in conjunction with the displayed battery icon, the battery must be replaced and recharged.


You can charge the battery by either of the following methods:

- **Internal charging** — plug the Propaq MD into an auxiliary power adapter to automatically begin charging the installed battery pack. The front panel battery indicator operates as follows:

When the indicator is:	It means:
Steady yellow	Battery is charging.
Steady green	Battery is charged.
Alternating yellow and green	The charge state cannot be determined or a battery charging fault has been detected.
Not lit	No battery in device.

Note: Upon power up, it takes approximately 45 seconds for the LEDs on the battery to accurately display run time.

- **External charging** — use the ZOLL SurePower Battery Charger with the Propaq MD battery adapter to charge the battery pack and test the battery's capacity. For details, refer to the *SurePower II Battery Pack Guide*.



The Recalibration LED icon () lights for approximately 10 seconds (after you press and release the **Display** button) if the battery needs to be calibrated. If the Recalibration LED lights, the runtime indicator will not display run time for that battery. For best performance of the battery, you should recalibrate the battery as soon as possible.

To manually recalibrate the SurePower II Battery Pack, you can insert the battery into the SurePower Charger Station and perform a Manual Test (for more information, see the ZOLL *SurePower Charger Station Operator's Guide*).

After you recalibrate the battery, the Recalibration LED will only flash when you press the **Display** button.

Ready For Use (RFU) Indicator

The Propaq MD has an RFU indicator on the front panel that indicates if the device is ready for use. The RFU indicator has three states which are described in the following table.

State	Description	Action
Ready for Use 	<p>The device is ready for use. Patient monitoring, defibrillation, and pacing parameters are functional and the battery is above the low battery capacity.</p> <p>Note: If the device is plugged into the auxiliary power adapter, the Ready for Use indicator may display even if the battery is depleted. Check the status of the battery before removing the device from the auxiliary power adapter.</p>	None required.
Flashing	<p>One or more of the following has occurred:</p> <ul style="list-style-type: none"> • The battery is not properly installed. • A low battery is installed. • A battery fault has occurred. • There is no battery installed while connected to auxiliary power. • One or more patient monitoring parameters have failed self-test (NIBP, SpO₂, CO₂, IBP, or Temp). • The front panel button self-test failed. • The speech database self-test failed. 	Install a fully charged battery in the unit and check the RFU indicator again. If the RFU indicator continues to flash, remove the unit from service and contact the appropriate technical personnel or the ZOLL Technical Service Department.
Do Not Use 	<p>One or more of the following has occurred:</p> <ul style="list-style-type: none"> • The battery is not properly installed. • No battery is installed and auxiliary power is not present. • A very low battery (below software shutdown limit) was installed. • ECG, defibrillator, or pacer self-tests have failed, or other critical self-tests have failed. 	Install a fully charged battery in the unit and check the RFU indicator again. If the RFU indicator continues to display the Do Not Use symbol, remove the unit from service and contact the appropriate technical personnel or the ZOLL Technical Service Department.

Safety Considerations



All operators should review these safety considerations before using the Propaq MD unit.

Propaq MD units are high-energy defibrillators capable of delivering 200 joules. To completely deactivate the unit, press the power switch to turn the unit off.

To manually disarm a charged (or charging) defibrillator, do one of the following:

- Press the **Disarm** quick access key.
- Change the selected energy.
- Press the power switch to turn the unit off.

For safety, the Propaq MD automatically disarms if left charged for more than 60 seconds if the **Shock** button (⚡) is not pressed.

Warnings

General

Federal (U.S.A.) law restricts this defibrillator to sale by or on the order of a physician.

Only appropriately trained, skilled personnel who are familiar with equipment operation should perform emergency defibrillation. The prescribing physician should determine what training, such as Advanced Cardiac Life Support (ACLS) or Basic Life Support (BLS) certification, is appropriate.

Only skilled personnel trained in Advanced Cardiac Life Support (ACLS) and who are familiar with equipment operation should perform synchronized cardioversion. The precise cardiac arrhythmia must be determined before attempting defibrillation.

These operating instructions describe the functions and proper operation of the Propaq MD products. They are not a substitute for a formal patient care training course. Operators should obtain formal training from an appropriate authority before using this defibrillator for patient care.

Proper operation of the unit and correct electrode placement is critical to obtaining optimal results. Operators must be thoroughly familiar with proper device operation.

The use of external pacing/defibrillation electrodes, accessories, or adapter devices from sources other than ZOLL is not recommended. ZOLL makes no representations or warranties regarding the performance or effectiveness of its products when used with pacing/defibrillation electrodes or adapter devices from other sources. Defibrillator failures attributable to the use of pacing/defibrillation electrodes or adapters not manufactured by ZOLL might void ZOLL's warranty.

At receipt of shipment, check pacing/defibrillation electrodes to ensure compatibility.

Allow ample slack in cables to make sure that cables do not tug at electrodes.

Do not disassemble the unit. A shock hazard exists. Refer all problems to authorized service personnel.

Follow all recommended maintenance instructions. If a problem occurs, obtain service immediately. Do not use the defibrillator until it has been inspected by appropriate personnel.

The Propaq MD unit might not perform to specifications when stored at the upper or lower extreme limits of storage temperature and then immediately put into use. The Propaq MD unit should not be stored or used outside of the environmental limits provided in Appendix A of this manual.

Avoid using the Propaq MD adjacent to, or stacked on, other equipment. If unavoidable, verify that the unit operates normally in this configuration before clinical use.

The Propaq MD unit should be installed and put into service according to the EMC information in Appendix A of this manual.

Do not use internal paddles while the Propaq MD unit's auxiliary power source is connected to an aircraft AC power operating at a frequency of 400 Hz.

The use of accessories, transducers, and cables other than those specified in this manual and related Propaq MD option manual inserts may result in increased emissions or decreased immunity of the Propaq MD.

Perform functional test of internal paddles prior to use.

Do not use or place the unit in service if the Ready For Use indicator (at the upper right of the front panel) displays a red circle with a line through it.

Carefully route patient cables to avoid tripping over them, or inadvertently pulling the unit onto the patient.

Always inspect the unit for damage if it has been dropped.

Only authorized personnel should use the Supervisor menus.

If uncertain about the accuracy of any measurement, first check the patient's vital signs by alternate means, and then make sure the monitor is functioning correctly.

Before disposing of equipment, in order to avoid contaminating or infecting personnel, the environment, or other equipment, it is important to disinfect and decontaminate the monitor/defibrillator and any appropriate device accessories appropriately and remove the batteries. Then dispose of the device and accessories in accordance with your country's regulations for equipment containing electronic parts.

ECG Monitoring

Implanted pacemakers might cause the heart rate meter to count the pacemaker rate during incidents of cardiac arrest or other arrhythmias. Dedicated pacemaker detection circuitry may not detect all implanted pacemaker spikes. Check the patient's pulse; do not rely solely on heart rate meters. Patient history and physical examination are important factors in determining the presence of an implanted pacemaker. Pacemaker patients should be carefully observed. See "Pacemaker Pulse Rejection:" on page A-15 of this manual for disclosure of the pacemaker pulse rejection capability of this instrument.

Use only ECG electrodes that meet the AAMI standard for electrode performance (AAMI EC-12). Use of electrodes not meeting this AAMI standard could cause the ECG trace recovery after defibrillation to be significantly delayed.

Prior to attempting synchronized cardioversion, ensure the ECG signal quality is good and that sync markers are displayed above each QRS complex.

Do not place electrodes directly over an implanted pacemaker.

The Propaq MD unit detects ECG electrical signals only. It does not detect a pulse (effective circulatory perfusion). Always verify pulse and heart rate by physical assessment of the patient. Never assume that the display of a nonzero heart rate means that the patient has a pulse.

Excessive artifact can result due to improper skin preparation of the electrode sites. Follow skin preparation instructions in Chapter 6: "Monitoring ECG."

Equipment such as electrocautery or diathermy equipment, RFID readers, electronic article surveillance (EAS) systems, or metal detectors that emit strong radio frequency signals can cause electrical interference and distort the ECG signal displayed by the monitor, thereby preventing accurate rhythm analysis. Ensure adequate separation between such emitters, the device, and the patient when performing rhythm analysis.

Shock Hazard: Use of accessories, other than those specified in the operating instructions, may adversely affect patient leakage currents.

Certain line-isolation monitors may cause interference on the ECG display and may inhibit heart rate alarms.

Monitoring ECG through the paddles may result in inaccurate heart rate display due to artifact.

Defibrillation

The ZOLL Propaq MD can deliver 200 joules of electrical energy. If this electrical energy is not discharged properly, as described in this manual, the electrical energy could cause personal injury or death to the operator or bystander.

To avoid possible damage to the Propaq MD unit, turn off pacing before defibrillating the patient with a second defibrillator.

After a synchronized cardioversion, the SYNC mode may be cleared after each shock or disarm. The user may have to reselect (press) the **SYNC** button after each synchronized cardioversion shock performed on a patient. In Defib/Pacer Default settings in the Supervisor Setup menu, the Propaq MD can be configured to remain in the SYNC mode after each synchronized cardioversion.

Synchronized cardioversion can be performed in the paddle monitoring mode. However, it is possible that artifact can be produced by the moving paddles, which could cause the defibrillator to trigger on the artifact. It is recommended that monitoring in leads I, II or III be used during synchronized cardioversion. Paddle monitoring should not be used for elective cardioversions procedures.

To avoid stress to the defibrillator or the tester, never attempt to repeatedly charge and discharge the defibrillator in rapid succession. If a need for repetitive testing arises, allow a waiting period of at least 2 minutes after every third discharge.

In the SYNC mode, the defibrillator does not discharge without a command signal (R-wave detection) from the ECG monitor indicated by a SYNC marker on the trace and a flashing SYNC indicator.

If conductive gel forms a continuous path between the defibrillator electrodes, delivered energy may be dramatically reduced to zero. In this case, reposition the electrodes to eliminate the shunting path before attempting additional shocks.

Improper defibrillation technique can cause skin burns. To limit possible skin burns, use only ZOLL defibrillation gel on paddles, ensure the gel covers the entire paddle surface and press firmly against patient's chest.

If a new energy level is selected after the **CHARGE** button is pushed and while the defibrillator is charging or charged, the defibrillator will disarm. The **CHARGE** button will need to be pressed again to charge to the new energy level.

Prior to defibrillation, disconnect from the patient any medical electronic device that is not labeled "defibrillation protected."

Before charging the defibrillator, verify that the energy selected on the display is the desired output.

Defibrillation takes priority over external pacing. Should the defibrillator be charged during the administration of external pacing, the pacer turns off and the defibrillator charges to the selected energy.

If the Propaq MD unit is in a shock-ready state, and you have to change the patient mode, wait until the unit disarms itself. Pressing the **SHOCK** button immediately after changing the patient mode may result in the delivery of energy that is incorrect for the newly selected patient type.

When using external or internal paddle sets, the Propaq MD unit may display the *RELEASE SHOCK BUTTON* message while the unit is charging. If you are pressing the paddles' shock buttons when the *RELEASE SHOCK BUTTON* message appears, you must release the shock buttons for the unit to become shock-ready. If you are not pressing the paddles' shock buttons when the *RELEASE SHOCK BUTTON* message appears, then the paddles are defective -- replace the defective paddles immediately with either another set of paddles or a multifunction electrode. **DO NOT** attempt to deliver therapy using the defective paddles by pressing the **SHOCK** button on the face of the Propaq M unit -- pressing the **SHOCK** button will **NOT** deliver therapy; pressing the **SHOCK** button will, however, cause the Propaq MD unit to remove the *RELEASE SHOCK BUTTON* message from the display.

Pacing

Ventricular fibrillation does not respond to pacing and requires immediate defibrillation. Therefore, the patient's dysrhythmia must be determined immediately, so that you can employ appropriate therapy. If the patient is in ventricular fibrillation and defibrillation is successful but cardiac standstill (asystole) ensues, you should use the pacemaker.

Ventricular or supraventricular tachycardias can be interrupted with pacing, but in an emergency or during circulatory collapse, synchronized cardioversion is faster and more certain.

Pulseless electrical activity (PEA) can occur following prolonged cardiac arrest or in other disease states with myocardial depression. Pacing might then produce ECG responses without effective mechanical contractions, making other effective treatment necessary.

Pacing can evoke undesirable repetitive responses, tachycardia, or fibrillation in the presence of generalized hypoxia, myocardial ischemia, cardiac drug toxicity, electrolyte imbalance, or other cardiac diseases.

Pacing by any method tends to inhibit intrinsic rhythmicity. Abrupt cessation of pacing, particularly at rapid rates, can cause ventricular standstill and should be avoided.

Noninvasive temporary pacing can cause discomfort of varying intensity, which occasionally can be severe and preclude its continued use in conscious patients.

Similarly, unavoidable skeletal muscle contraction might be troublesome in very sick patients and might limit continuous use to a few hours. Erythema or hyperemia of the skin under the hands-free therapy electrodes often occurs; this effect is usually enhanced along the perimeter of the electrode. This reddening should lessen substantially within 72 hours.

There have been reports of burns under the anterior electrode when pacing adult patients with severely restricted blood flow to the skin. Prolonged pacing should be avoided in these cases and periodic inspection of the underlying skin is advised.

There are reports of transient inhibition of spontaneous respiration in unconscious patients with previously available units when the anterior electrode was placed too low on the abdomen.

The pacing rate determination can be adversely affected by artifact. If the patient's pulse and the heart rate display are significantly different, external pacing pulses may not be delivered when required.

Artifact and ECG noise can make R-wave detection unreliable, affecting the HR meter and the demand mode pacing rate. Always observe the patient closely during pacing operations. Consider using asynchronous pacing mode if a reliable ECG trace is unobtainable.

Transcutaneous pacing should not be used to treat V FIB (ventricular fibrillation). In cases of V FIB, immediate defibrillation is advised.

Transcutaneous pacing may cause discomfort ranging from mild to severe, depending on the patient's tolerance level, muscle contractions and electrode placement. In certain cases, discomfort may be decreased by slightly relocating the pacing pads.

It is important to monitor the patient closely to verify that both mechanical and electrical capture are occurring. Electrical capture can be verified by observing the presence of a large ectopic beat after the pacing pulse is delivered. The size and morphology of the beat are dependent on the patient. In some instances the beat may appear as a relatively normal looking QRS pulse. Mechanical capture can be verified by checking for signs of increased blood flow i.e., reddening of the skin, palpable pulses, increased blood pressure, etc. Continuously observe the patient during pacing administration, to insure capture retention. Do not leave the patient unattended when administering external pacing therapy.

Warning! This device can only be used for external pacing of patients and cannot be used for internal pacing. Do not connect internal pacing lead wires to the Propaq MD defibrillator.

CPR

Place the patient on a firm surface before performing CPR.

The patient must be motionless during CPR for accurate CPR measurements.

Pulse Oximeter

Keep the ZOLL finger probe clean and dry.

SpO₂ measurements may be affected by certain patient conditions: severe right heart failure, tricuspid regurgitation or obstructed venous return.

SpO₂ measurements may be affected when using intravascular dyes, in extreme vasoconstriction or hypovolemia or under conditions where there is no pulsating arterial vascular bed.

SpO₂ measurements may be affected in the presence of strong EMI fields, electrosurgical devices, IR lamps, bright lights, improperly applied sensors; the use of non-ZOLL sensors, or damaged sensors; in patients with smoke inhalation, or carbon monoxide poisoning, or with patient movement.

Tissue damage can result if sensors are applied incorrectly, or left in the same location for an extended period of time. Move sensor every 4 hours to reduce possibility of tissue damage.

Do not use any oximetry sensors during MRI scanning. MRI procedures can cause conducted current to flow through the sensors, causing patient burns.

Do not apply SpO₂ sensor to the same limb that has an NIBP cuff. The SpO₂ alarm may sound when the arterial circulation is cut off during NIBP measurements, and may affect SpO₂ measurements.

In some instances, such as obstructed airway, the patient's breathing attempts may not produce any air exchange. These breathing attempts can still produce chest size changes, creating impedance changes, which can be detected by the respiration detector. It is best to use the pulse oximeter whenever monitoring respirations, to accurately depict the patient's respiratory condition.

Noninvasive Blood Pressure

Only a physician can interpret pressure measurements.

Blood pressure measurement results may be affected by the position of the patient, his or her physiological condition and other factors.

Substitution of a component different from that supplied by ZOLL (e.g., cuff, hoses, etc.) may result in measurement error. Use only ZOLL-approved cuffs and hoses. To avoid the risk of intravenous line misconnection and possible introduction of air into a patient's blood, do not modify the NIBP system or hoses with Luer Lock adapters.

Do not use a blood pressure cuff on the limb being used for IV infusion or for SpO₂ monitoring.

Accurate pressure readings may not be achieved on a person experiencing arrhythmias, shaking, convulsions or seizures. Medication may also affect pressure readings. The correct size cuff is essential for accurate blood pressure readings.

Blood pressure hoses must be free of obstructions and crimps.

If the patient's cuff is not at heart level, an error in measurement may result.

When monitoring blood pressure at frequent intervals, observe the cuffed extremity of the patient for signs of impeded blood flow.

Do not monitor one patient's NIBP while monitoring another patient's ECG.

Blood pressure measurement may be inaccurate if taken while accelerating or decelerating in a moving vehicle.

If an NIBP measurement result is questionable or "motion" indication is displayed, repeat the measurement. If the repeated measurement result is still questionable, use another blood pressure measurement method.

Do not use the NIBP on cardiopulmonary bypass patients.

IBP

To ensure compatibility and electrical safety, accessory pressure sensors should comply with ANSI/AAMI BP-22 and IEC 60601-2-34 for IBP or ANSI/AAMI NS28 for ICP.

Follow instructions supplied with any accessory pressure sensor regarding calibration and removal of trapped air.

Avoid touching metal parts of any transducer while it is in contact with the patient.

Do not reuse any components that are labeled for single use only.

Transducers should be rated to withstand an accidental drop of at least a meter onto a hard surface.

Transducers that are subject to immersion in liquids should be rated as watertight.

CO₂

During MRI scanning, the monitor must be placed outside the MRI suite. When the monitor is used outside the MRI suite, EtCO₂ monitoring can be implemented using a long FilterLine[®] which permits placement of the monitor outside the MRI suite.

When using the monitor with anesthetics, nitrous oxide or high concentrations of oxygen, connect the gas outlet to a scavenger system.

Use only Oridion Microstream CO₂ sampling lines.

Microstream CO₂ sampling lines are labeled for single patient use only. Do not reuse sampling lines.

If using the CO₂ Monitor for extended critical care, replace the airway adapter every 24 hours or when it becomes occluded.

CO₂ readings and respiratory rate can be affected by sensor application errors, certain ambient environmental conditions, and certain patient conditions.

Respiration

Do not operate the Propaq MD with any other monitor with respiration measurements on the same patient. The two devices could affect the respiration accuracy.

The device should not be used as an apnea monitor.

Ferromagnetic Equipment

Biomedical equipment and accessories, such as ECG electrodes, cables, and oximeter probes contain ferromagnetic materials. Ferromagnetic equipment must not be used in the presence of high magnetic fields created by magnetic resonance imaging (MRI) equipment.

The large magnetic fields generated by an MRI device can attract ferromagnetic equipment with an extremely violent force, which could cause serious personal injury or death to persons between the equipment and the MRI device.

Battery

Although the device can operate with auxiliary power alone, ZOLL strongly recommends that you operate the unit with a battery installed at all times. Operating the unit with a battery provides a backup in case of AC power shortage, and results in faster charge time. The battery can be automatically recharged while it is installed in the unit. Keep a fully charged spare battery pack with the defibrillator at all times.

Test battery packs regularly. A battery that does not pass the ZOLL charger's capacity test might cause the Propaq MD unit to shut down unexpectedly.

If the Low Battery indication occurs at any time during operation, immediately replace the battery pack.

If the *LOW BATTERY* icon appears, plug the Propaq MD unit into a power source or install a fully charged battery pack. When the warning low battery shutdown prompt appears, immediately replace the battery pack with a fully charged pack or plug the Propaq MD unit into a power source, as unit shut down due to a low battery condition is imminent.

If mistreated, a battery pack might explode. Do not disassemble a battery pack or dispose of it in fire.

Operator Safety



The Propaq MD can deliver 200 joules of electrical energy. If this electrical energy is not discharged properly, as described in this manual, the electrical energy could cause personal injury or death to the operator or bystanders.

Do not use the Propaq MD in the presence of oxygen-rich atmospheres, flammable anesthetics, or other flammable agents (such as gasoline). Using the unit in such environments might cause an explosion.

Do not use the unit near or within standing water. Electrical safety might be compromised when the defibrillator is wet.

Never discharge the unit with the defibrillation electrodes or paddles shorted together or in open air.

Do not discharge the defibrillator except as indicated in the instructions. Discharge the defibrillator only when defibrillation electrodes or paddles are properly applied to the patient.

To avoid the risk of electrical shock, this equipment must only be connected to AC mains with protective earth.

To avoid risk of electrical shock, do not touch the gelled area of the hands-free therapy electrodes during pacing or defibrillation.

To avoid risk of electrical shock, do not allow electrolyte gel to accumulate on hands or paddle handles.

To avoid risk of electrical shock, do not allow patient connectors to contact other conductive parts, including earth.

For defibrillation using paddles, use only high-conductivity electrolyte gel specified for such use by the manufacturer.

When using paddles for defibrillation, use your thumbs to operate the **SHOCK** buttons. Doing so avoids inadvertent shock to the operator.

The use of accessory equipment that does not comply with the equivalent safety requirements of the Propaq MD defibrillator could reduce the level of safety of the combined system. When choosing accessory equipment, consider the following:

- Use of the accessory in the patient vicinity.
- Evidence that the safety certification of the accessory has been performed in accordance with the appropriate IEC (EN) 60601-1 and/or IEC (EN) 60601-1-1 harmonized national standards.

Always check that the equipment functions properly and is in proper condition before use.

Disconnect all electro-medical equipment that is not defibrillation-protected from the patient prior to defibrillation.

Before discharging the defibrillator, warn everyone to **STAND CLEAR** of the patient.

Do not touch the bed, patient, or any equipment connected to the patient during defibrillation. A severe shock can result. To avoid hazardous pathways for the defibrillation current, do not allow exposed portions of the patient's body to touch any metal objects, such as a bed frame.

To avoid risk of electrical shock, do not allow printer to come into contact with other conductive parts, such as equipment connected to the USB port.

Patient Safety



The AutoPulse Plus is only intended for use on adults 18 years of age or older.

Inappropriate defibrillation or cardioversion of a patient (for example, with no malignant arrhythmia) may precipitate ventricular fibrillation, asystole, or other dangerous arrhythmias.

Defibrillation without proper application of electrodes or paddle electrolyte gel might be ineffective and cause burns, particularly when repeated shocks are necessary. Erythema or hyperemia of the skin under the paddles, or electrodes often occurs; this effect is usually enhanced along the perimeter of the paddles or electrodes. This reddening should diminish substantially within 72 hours.

This equipment should be connected to only one patient at a time.

Use only OneStep Pediatric electrodes to defibrillate patients under 8 years of age. Use of adult electrodes, or pediatric electrodes other than OneStep Pediatric electrodes, can result in the delivery of excessive energy doses.

Neonatal and pediatric defibrillation energy level settings should be based on site-specific clinical protocols.

To ensure patient safety, do not place the monitor in any position that might cause it to fall on the patient.

To ensure patient safety, connect the Propaq MD only to equipment with circuits that are electrically isolated.

Use only high-quality ECG electrodes. ECG electrodes are for rhythm acquisition only; you cannot use ECG electrodes for defibrillation or pacing.

Do not use therapy or ECG electrodes if the gel is dried, separated, torn or split from the foil; patient burns may result from using such electrodes. Poor adherence and/or air pockets under therapy electrodes can cause arcing and skin burns.

Check the expiration date on the electrode packaging. Do not use electrodes after their expiration date.

Excessive body hair or wet, diaphoretic skin can inhibit electrode coupling to the skin. Clip excess hair and dry any moisture from the area where an electrode is to be attached.

Therapy electrodes should be replaced periodically during continuous pacing. Consult electrode directions for proper replacement instructions.

Prolonged pacing (more than 30 minutes), particularly in neonates or adults with severely restricted blood flow, may cause burns. Periodically inspect the skin under the electrodes.

Carefully route the patient cables away from the patient's neck to reduce the possibility of patient entanglement or strangulation.

To avoid electrosurgery burns at monitoring sites, ensure proper connection of the electrosurgery return circuit so that a return path cannot be made through monitoring electrodes or probes.

During electrosurgery, observe the following guidelines to minimize electrosurgery unit (ESU) interference and provide maximum operator and patient safety:

- Keep all patient monitoring cables away from earth ground, ESU knives, and ESU return wires.
- Use electrosurgical grounding pads with the largest practical contact area.

Always ensure proper application of the electrosurgical return electrode to the patient.

Check electrical leakage levels before use. Leakage current might be excessive if more than one monitor or other piece of equipment is connected to the patient.

Cautions

If the unit is to be stored longer than 30 days, remove the battery pack.

Do not sterilize the defibrillator, or its accessories unless the accessories are labelled as sterilizable.

Do not immerse any part of the defibrillator in water.

Do not use the defibrillator if excessive condensation is visible on the device. Wipe only the outside with a damp cloth.

Do not use ketones (such as acetone or MEK) on the defibrillator.

Avoid using abrasives (including paper towels) on the display window.

To achieve the specified level of protection against spilled or splashed liquids, thoroughly dry all exposed surfaces of this device prior to operation or connections to auxiliary power.

If liquids enter the device connectors, remove all liquid from the connectors and allow the device to dry thoroughly prior to use.

Grounding reliability can be achieved only when the equipment is connected to a receptacle marked "HOSPITAL ONLY," "HOSPITAL GRADE," or equivalent. If the grounding integrity of the line cord or ac receptacle is questionable, operate the defibrillator using battery power only.

Do not connect to an electrical outlet controlled by a wall switch or dimmer.

To protect the unit from damage during defibrillation, for accurate ECG information, and to protect against noise and other interference, use only internal current-limiting ECG cables specified or supplied by ZOLL.

For continued safety and EMI performance, use only the line cord supplied by ZOLL.

Electrical installation of the room or the building in which the monitor is to be used must comply with regulations specified by the country in which the equipment is to be used.

Dispose of battery packs in accordance with national, regional and local regulations. Battery packs should be shipped to a reclamation facility for recovery of metal and plastic compounds as the proper method of waste management.

Do not place the device where the controls can be changed by the patient.

Restarting the Defibrillator

Certain events require the Propaq MD products to be restarted after they shut off or become inoperative (for example, when the battery runs down and the unit shuts off).

In such a case, always try to restore defibrillator operation as follows:

1. Press the power switch on the top of the unit to turn it off.
2. If necessary, replace a depleted battery with a fully charged pack, or connect the defibrillator to auxiliary power.
3. Press the power switch on the top of the unit to turn it back on.

This sequence is necessary to restart the defibrillator and can also be used to clear some fault messages when immediate use of the defibrillator is required.

If the Propaq MD unit is powered off for less than 2 minutes, all patient monitoring parameter settings will be retained. If the unit has been powered off for at least two minutes, it will be considered a New Patient and all of the patient-specific parameters (alarm limits, defibrillator energy, etc.) will be reset to their default values.

FDA Tracking Requirements

U.S. Federal Law (21 CFR 821) requires the tracking of defibrillators. Under this law, owners of this defibrillator must notify ZOLL Medical Corporation if this product is

- received
- lost, stolen, or destroyed
- donated, resold, or otherwise distributed to a different organization

If any such event occurs, contact ZOLL Medical Corporation in writing with the following information:

1. Originator's organization – Company name, address, contact name, and contact phone number
2. Model number, and serial number of the defibrillator
3. Disposition of the defibrillator (for example, received, lost, stolen, destroyed, distributed to another organization), new location and/or organization (if known and different from originator's organization) – company name, address, contact name, and contact phone number
4. Date when the change took effect

Please address the information to:

ZOLL Medical Corporation
Attn: Tracking Coordinator
269 Mill Road
Chelmsford, MA 01824-4105

Fax: +1-978-421-0025

Telephone: +1-978-421-9655

Notification of Adverse Events

As a health care provider, you may have responsibilities under the Safe Medical Devices Act (SMDA), for reporting to ZOLL Medical Corporation, and possibly to the FDA, the occurrence of certain events.

These events, described in 21 CFR Part 803, include device-related death and serious injury or illness. In addition, as part of our Quality Assurance Program, ZOLL Medical Corporation requests to be notified of device failures or malfunctions. This information is required to ensure that ZOLL Medical Corporation provides only the highest quality products.

Software License

Note: Read this Operator's Guide and License agreement carefully before operating any of the Propaq MD products.

Software incorporated into the system is protected by copyright laws and international copyright treaties as well as other intellectual property laws and treaties. This software is licensed, not sold. By taking delivery of and using this system, the Purchaser signifies agreement to and acceptance of the following terms and conditions:

1. **Grant of License:** In consideration of payment of the software license fee which is part of the price paid for this product ZOLL Medical Corporation grants the Purchaser a non-exclusive license, without right to sublicense, to use the system software in object-code form only.
2. **Ownership of Software/Firmware:** Title to, ownership of and all rights and interests in the system software and all copies thereof remain at all times vested in the manufacturer, and Licensors to ZOLL Medical Corporation and they do not pass to purchaser.
3. **Assignment:** Purchaser agrees not to assign, sublicense or otherwise transfer or share its rights under the license without the express written permission of ZOLL Medical Corporation.
4. **Use Restrictions:** As the Purchaser, you may physically transfer the products from one location to another provided that the software/firmware is not copied. You may not disclose, publish, translate, release or distribute copies of the software/firmware to others. You may not modify, adapt, translate, reverse engineer, decompile, crosscompile, disassemble or create derivative works based on the software/firmware.

NO IMPLIED LICENSE

Possession or purchase of this device does not convey any express or implied license to use the device with replacement parts which would, alone, or in combination with this device, fall within the scope of one or more of the patents relating to this device.

Service

The Propaq MD only requires recalibration of the CO₂ module. Service is required after 20,000 hours of use of the CO₂ module. Appropriately trained and qualified personnel should, however, perform periodic tests of the defibrillator functionality to verify proper operation.

If a unit requires service, contact the ZOLL Technical Service Department.

For customers In the U.S.A.		For customers outside the U.S.A.
Telephone:	1-800-348-9011 1-978-421-9655	Call the nearest authorized ZOLL Medical Corporation representative.
Fax:	1-978-421-0010	To locate an authorized service center, contact the International Sales Department at ZOLL Medical Corporation 269 Mill Road Chelmsford, MA 01824-4105 Telephone: 1-978-421-9655

When requesting service, please provide the following information to the service representative:

- Unit serial number
- Description of the problem
- Department using the equipment and name of the person to contact
- Purchase order to allow tracking of loan equipment
- Purchase order for a unit with an expired warranty
- Sample ECG or other stripcharts demonstrating the problem (if available and applicable), less any confidential patient information.

Returning a unit for service

Before sending a unit to the ZOLL Technical Service Department for repair, obtain a service request (SR) number from the service representative.

Remove the battery pack from the unit. Pack the unit with its cables and battery in the original containers (if available) or equivalent packaging. Be sure the assigned service request number appears on each package.

For customers	Return the unit to
In the U.S.A.	ZOLL Medical Corporation 269 Mill Road Chelmsford, MA 01824-4105 Attention: Technical Service Department (<i>SR number</i>) Telephone: 1-800-348-9011
In Canada	ZOLL Medical Canada Inc. 1750 Sismet Road, Unit #1 Mississauga, ON L4W 1R6 Attention: Technical Service Department (<i>SR number</i>) Telephone: 1-866-442-1011
In other locations	The nearest authorized ZOLL Medical Corporation representative. To locate an authorized service center, contact the International Sales Department at ZOLL Medical Corporation 269 Mill Road Chelmsford, MA 01824-4105 Telephone: 1-978-421-9655

The ZOLL Serial Number

Each ZOLL product displays a serial number that contains information about that product. From left to right, ZOLL serial numbers are structured as follows:

- A two-character product code
- A three-character date-of-manufacture code
- A product serial number of six or more alphanumeric characters

The first two characters of the date-of-manufacture code give the last two digits of the year (for example, “06” appears for products manufactured in 2006). The last character of the date-of-manufacture code gives the month in which the product was manufactured. The month appears in the form of a single alphanumeric character: “A” for January, “B” for February, “C” for March, and so on through “L” for December.

The product serial number is a unique set of alphanumeric characters that ZOLL assigns to each individual unit.

Chapter 2

Product Overview

Defibrillator Controls and Indicators

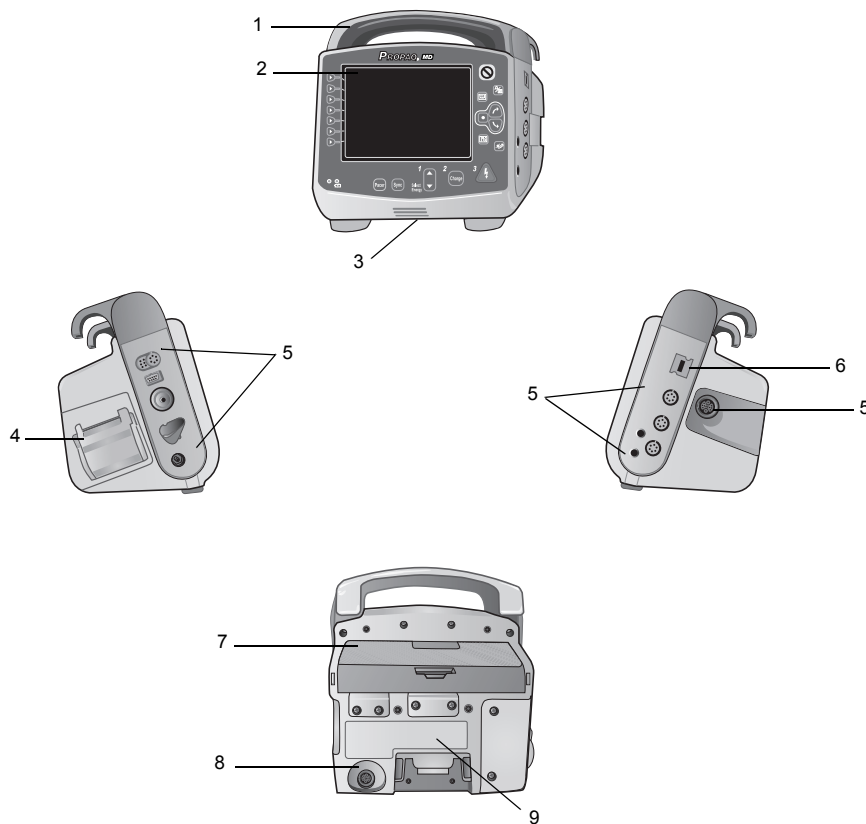


Table 2-1. Propaq MD Unit Features

	Item	Description
1	Handle	Integrated carrying handle.
2	Front panel	Includes the display screen and primary controls.
3	Speaker	Emits R-wave detection beeps and alarm tones.
4	Paper Compartment	Holds the paper for the printer.
5	Patient connectors	For details, refer to “Patient Cables and Connectors” on page 2-7.
6	USB device connector	For connecting the Propaq defibrillator to a USB device. For details, refer to “Transferring Data to a USB Device” on page 21-4.”
7	Battery compartment	Holds a rechargeable lithium ion battery pack.
8	Auxiliary power connector	For connecting the device to an auxiliary power adapter.
9	Dock connector	For connecting the device to a docking station.

The Front Panel

The front panel of the Propaq MD device includes the display screen, quick access keys, battery and auxiliary power indicators, Ready For Use (RFU) indicator, and the defibrillation front panel buttons: **Pacer**, **Sync**, **Select Energy**, **Charge**, and **Shock** (⚡). See Figure 2-1. Refer to Table 2-2 on page 2-3 for information about the controls and indicators.

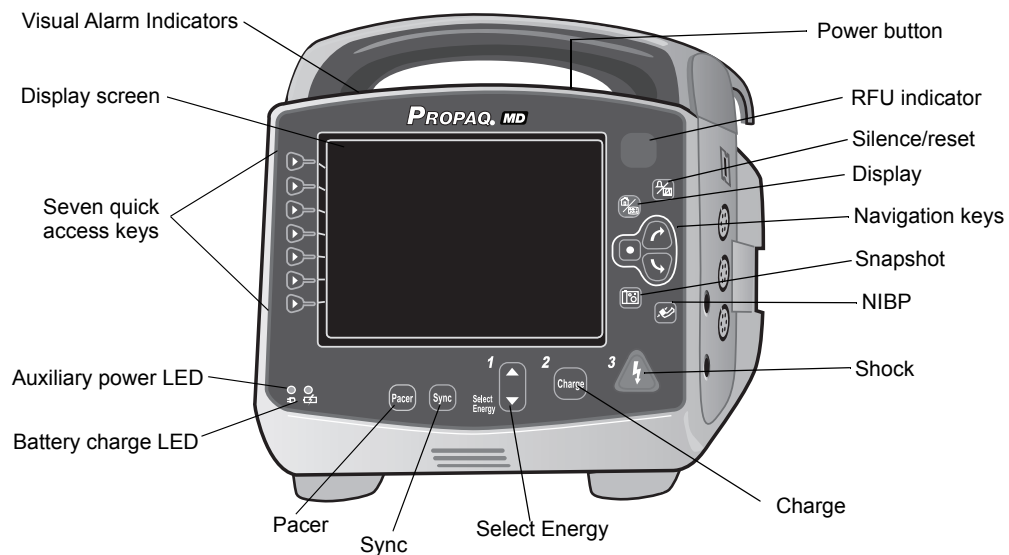


Figure 2-1. Propaq MD Front Panel

Table 2-2. Propaq MD Controls and Indicators















Control or Indicator	Description
Display screen	Shows therapeutic settings, physiological waveforms and other information for each monitored parameter, messages, time, and quick access key labels.
Quick access keys	Seven buttons control different functions of the unit. Labels for the quick access keys appear on the monitor display to the right of each key.
Auxiliary power LED	Illuminated when the unit is plugged in to an auxiliary power adapter.
Battery charge LED	Indicates battery status: Steady yellow: Battery is charging. Steady green: Battery is charged. Alternating green and yellow: The charge state cannot be determined or a battery charging fault has been detected. No light: Battery is not installed.
Visual alarm indicators	Red, yellow, and green lights located on the top of the unit that flash on and off when the unit is powered up and are used to indicate a patient alert, equipment alert, and data transfer.
Pacer button 	Displays pacer settings window to start/stop pacing activity or change the rate, output, or mode settings.
Sync button 	Activates the synchronized cardioversion mode.
Select Energy buttons 	Two sets of up-down arrow buttons control the selection of defibrillator energy; one set is located on the front panel and the other set is located on the STERNUM paddle.
Charge Button 	Charges the defibrillator to the selected energy. In addition to the Charge button on the front panel, there is one located on the APEX paddle handle.
Shock Button 	The front panel Shock button is only active when using hands-free therapy electrodes or internal defibrillation paddles without a discharge button. The Shock button illuminates when the device is charged and ready. To discharge the defibrillator when using paddles (internal or external) with discharge buttons, press and hold the SHOCK buttons on the paddles.
NIBP button 	Starts/stops an NIBP measurement.
Snapshot button 	Records 24 seconds of numeric and waveform data.

Table 2-2. Propaq MD Controls and Indicators (Continued)

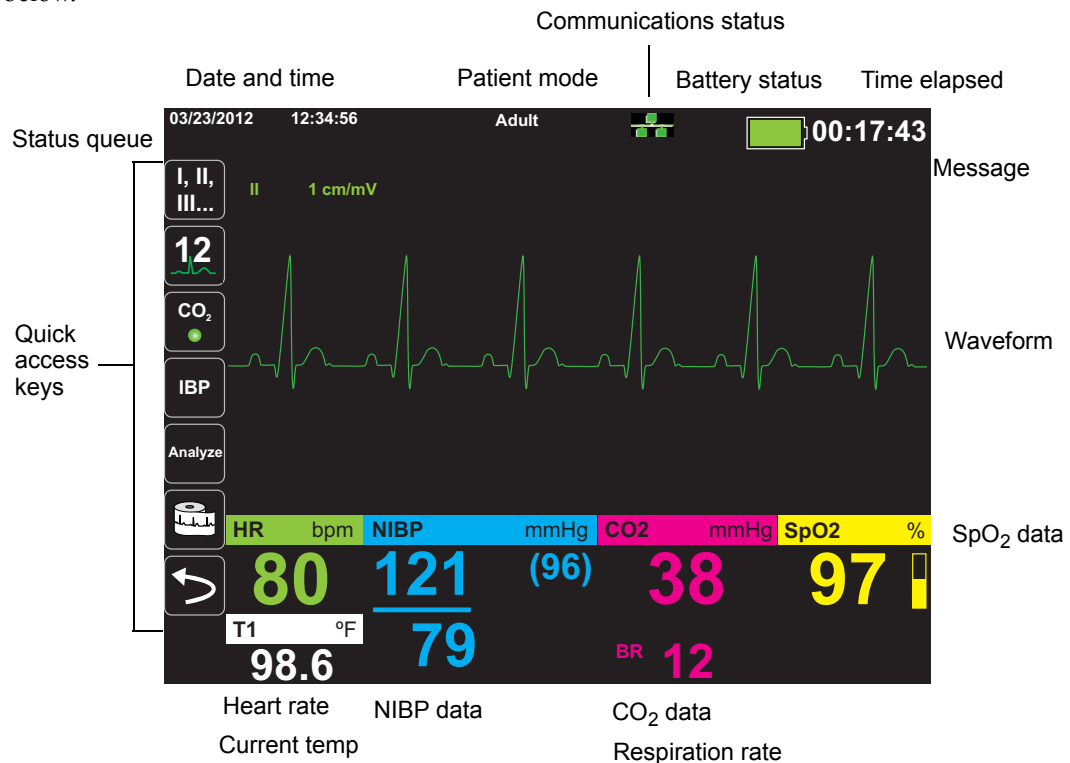
Control or Indicator	Description
Navigation keys 	<p> The up (clockwise) arrow will cause the cursor to travel in an upward direction if the cursor is being used to navigate through a vertical list or in a clockwise direction if the cursor is being used to navigate around the full screen. Likewise, the down (counterclockwise) arrow will cause the cursor to travel in a downward direction if the cursor is being used to navigate through a vertical list or in a counterclockwise direction if the cursor is being used to navigate around the full screen. The up (clockwise) and down (counterclockwise) arrows may also be used to modify parameter settings.</p> <p> The Select button acts based on what is highlighted.</p>
Display/Home button 	Cycles through three available display modes or functions as an Home button when in a menu.
Audio Pause (Silence)/Reset button 	Use to acknowledge a current alarm and pause (silence) the alarm audio for 90 seconds. Pressing Audio Pause (Silence)/Reset button before the Audio Pause (Silence) period has expired resets the alarm.
RFU indicator  Ready Do Not Use	Shows the status of the unit, based on its most recent readiness check. A red circle with a line through it indicates that the unit's readiness has been compromised and that it may not be ready for therapeutic use.
Power button 	Located on the top of the unit, this button turns the unit on and off. Note: The Propaq MD unit may display the message <i>Check Sensor or searching...</i> when the unit is powered on, but the SpO2 sensor has not yet been connected to the patient. If SpO2 monitoring is desired, connect the SpO2 sensor to the patient. See Chapter 10, "Pulse CO-Oximetry (SpO2)" for information on SpO2 monitoring.
Charge Indicator Light (not shown)	Located on the APEX paddle, this light turns on when the defibrillator is charged and ready.

Display Screen

The front panel includes a color display which shows:

- Date and time
- Patient mode
- Battery status indicator
- Time elapsed (since unit was turned on)
- Quick access keys
- Waveform source
- Color-coded waveforms and ECG lead identifiers
- SpO₂ numeric data
- Heart rate numeric data
- Respiration rate numeric data
- Temperature numeric data
- Non-invasive blood pressure numeric data
- EtCO₂ numeric data
- Invasive pressure numeric data
- The selected energy, charging status, and delivered energy for defibrillation and synchronized cardioversion
- Communications status (wireless or Ethernet connection)
- The output current and stimulus rate for pacing
- Messages and prompts

The layout of parameter values, waveforms, system data, and quick access key labels are shown below.








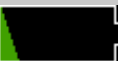




Color coding

To differentiate information for various parameters, the unit displays each type of information in a specific user-configurable color.

Battery Status and Auxiliary Power Indicators

The battery status indicator displays various battery icons to indicate the approximate remaining unit run time based on the charged state of the battery. Additionally, these icons provide indications of the status of the battery connection and communication with the unit. The auxiliary power indicator indicates that the unit is being powered by the auxiliary power adapter.

Note: Upon powering up the Propaq MD unit, the battery capacity will be displayed within approximately 15 seconds under normal conditions. Under some circumstances, such as activating the defibrillator immediately after the unit is turned on, the battery icon may display less than one hour battery capacity for up to two minutes after exiting the defibrillation mode.

Icon	Status	Indication/Action
	Auxiliary power adapter is connected	The unit is being powered by the auxiliary power adapter.
	No battery detected	Either there is no battery in the unit while it is being powered by the auxiliary power adapter, or the device cannot detect that the battery is connected.
	Low battery capacity	Replace the battery soon.
	Communication failure	The unit is unable to establish communication with the battery and the battery capacity is unknown. Check the battery contacts.
	Battery fault	A battery fault has been detected. Replace the battery.
	Battery Level 1	The battery has less than one hour of remaining battery capacity.
	Battery Level 2	The battery has greater than one hour of remaining battery capacity.
	Battery Level 3	The battery has greater than two hours of remaining battery capacity.
	Battery Level 4	The battery has greater than three hours of remaining battery capacity.
	Battery Level 5	The battery is fully charged.

Patient Cables and Connectors

The left and right sides of the unit include sets of connectors for patient cables.

Note: The SpO₂, NIBP, CO₂, Temperature, and IBP functions are optional. If your unit does not include these options, it does not have the applicable connectors.

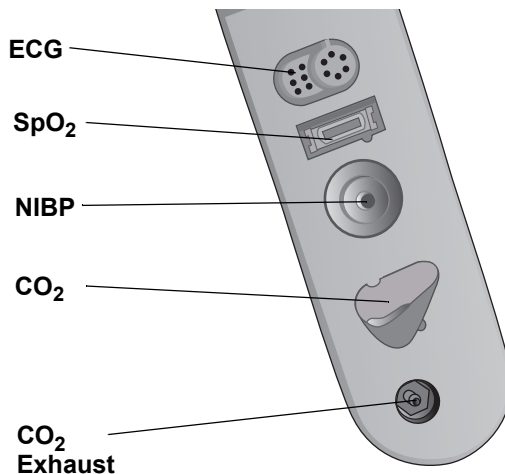


Figure 2-2. Patient Cable Connectors on Left Side of Unit

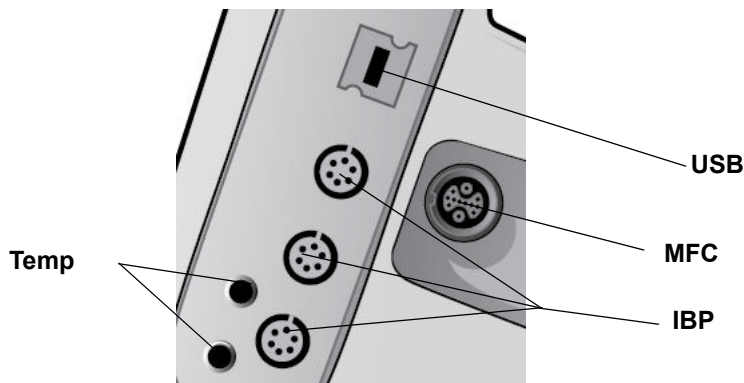


Figure 2-3. Patient Cable Connectors on Right Side of Unit

Connector	Description
ECG	For connecting 3- or 5-lead ECG cable (12-lead monitoring is optional).
SpO ₂	For connecting Masimo SpO ₂ /CO cable.
NIBP	For connecting NIBP hose.
CO ₂	For connecting CO ₂ sampling line.
Temp	For connecting temperature probe(s).
Multifunction Cable (MFC)	For connecting paddles or ZOLL hands-free therapy and pacing electrodes.
USB	For connecting the Propaq MD defibrillator to a USB device.
IBP	For connecting IBP cable(s).

Multifunction Cable (MFC)

The unit ships with an MFC that is used to defibrillate the patient. Any other cables that ship with your unit depend on the options you have purchased. See “ZOLL Cables and Compatible Accessories” on page 2-10 for a list of compatible accessories.

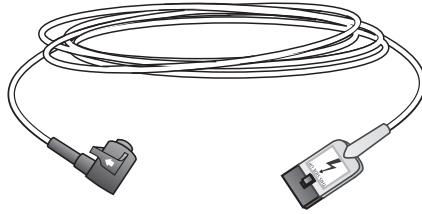


Figure 2-4. MFC

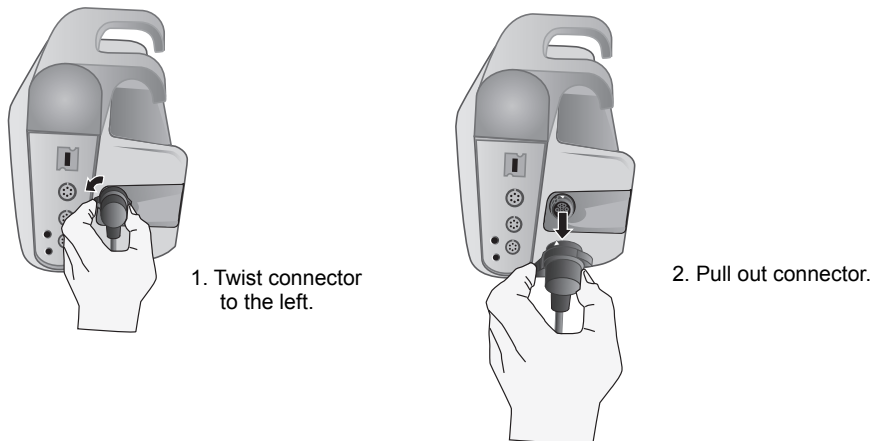
Inserting Cables into Unit

Plug the cable connector into the therapy input connector on the right side of the unit. Push the connector in with the arrows aligned. The connector will click when it locks into place.



Removing Cables from Unit

Twist the connector to the left to unlock it, and pull out the cable connector.



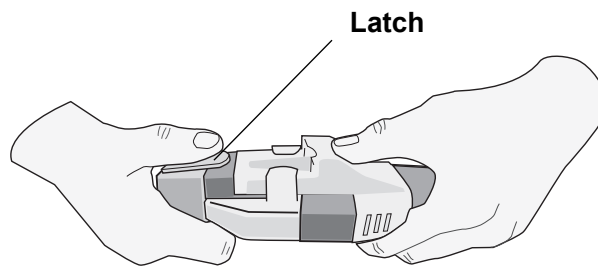
OneStep Cable (optional)

The OneStep™ cable is used with OneStep electrodes for ECG monitoring and for use with Real CPR Help. See “ZOLL Cables and Compatible Accessories” on page 2-10 for a list of compatible accessories.

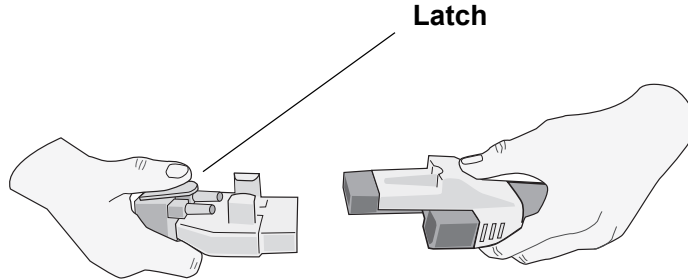


Figure 2-5. OneStep Cable

When connecting a OneStep electrode to the OneStep cable, push the two connectors together until the latch clicks, as shown.

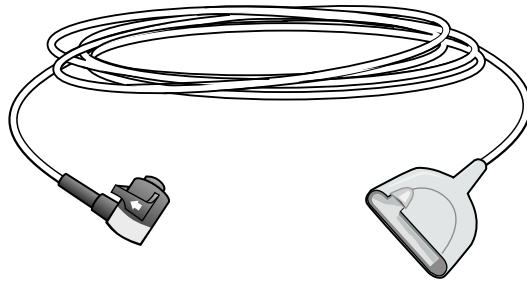


When disconnecting the OneStep electrode and OneStep cable, press down the latch with your thumb as shown.



MFC with CPRD Connector (optional)

The MFC with CPRD connector is used for ECG monitoring and for use with Real CPR Help. See the table below for a list of compatible accessories.



ZOLL Cables and Compatible Accessories

Cable Description	Internal Paddles	External Paddles	Stat-Padz	Pedi -Padz II	CPR-D Padz	CPR-Stat-Padz
MFC	√	√	√	√ With MFC - CPRD adapter	√ With MFC - CPRD adapter	√ With MFC - CPRD adapter
OneStep Cable	√	√	√			
MFC with CPRD Connector			√	√	√	√

Propaq MD with AutoPulse Plus (optional)

The Propaq MD with the AutoPulse option allows for the integration of ZOLL's non-invasive AutoPulse Plus cardiac support pump with the Propaq MD unit to provide the administration of uninterrupted, full-force compressions that are coordinated with timed shock delivery. This integration enables you to monitor the ECG; administer defibrillation at the optimal point in the compression cycle with virtually uninterrupted, continuous CPR; and enhance shock success while maintaining circulatory support. AutoPulse Plus operation is available in AED, Manual, and Advisory defibrillation modes.

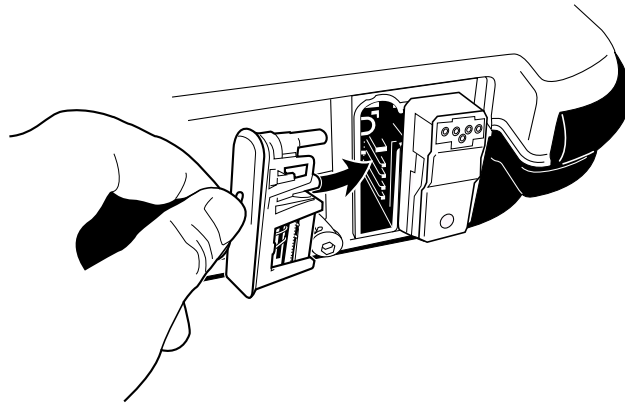
Note: For information on using the AutoPulse Plus device see the *AutoPulse Resuscitation System Model 100 User Guide*.

Warning! **The AutoPulse Plus is only intended for use on adults 18 years of age or older.**

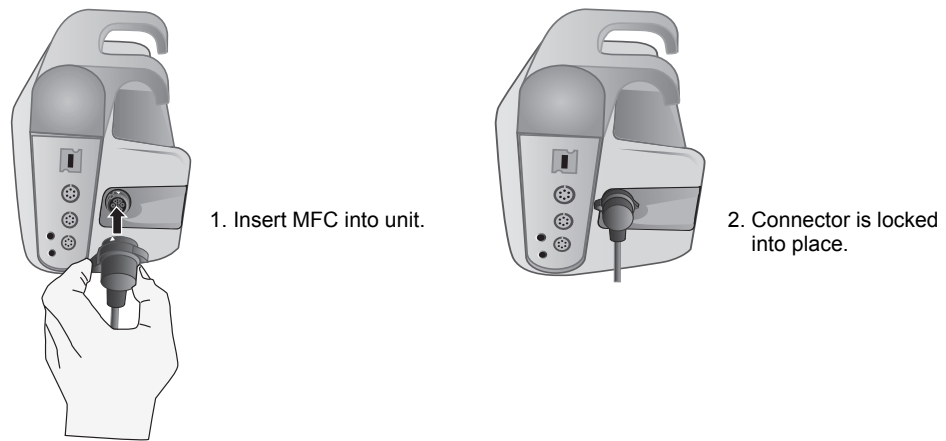
To connect to the AutoPulse Plus:

1. Plug the electrodes into the Connector Site located on at the top of the AutoPulse Plus device next to the Battery bay as shown below. The Electrodes Connector should be firmly seated into the Connector Site.

Note: The AutoPulse Plus option is compatible with CPR-D Padz™, Stat-Padz II® CPR Stat-Padz™ electrodes.

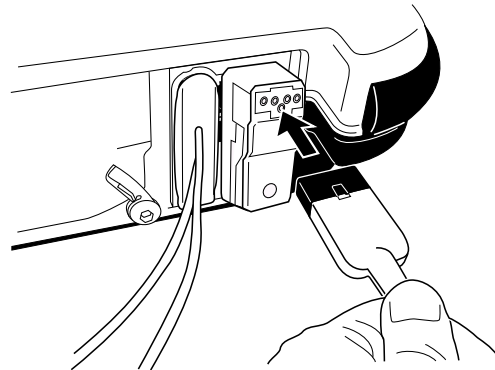


2. Plug the Multifunction Cable (MFC) or the OneStep Cable connector into the therapy input connector on the right side of the Propaq MD unit. Push the connector in with the arrows aligned. The connector will click when it locks into place.



3. Plug the other end of the MFC or OneStep cable into the Connector Site on at the top of the AutoPulse Plus as shown below. The cable should be firmly seated into the Connector Site.

Note: The MFC or OneStep cable plugs in to an AutoPulse Adapter installed at the Connector Site. For information on attaching the AutoPulse Adapter to the Connector Site on the AutoPulse Plus see the *Instructions for Use* that ship with the adapter.



When the Propaq MD connects to the AutoPulse Plus, the APLS icon appears on the Propaq MD display in place of the Pads icon. If APLS icon does not appear on the Propaq MD display, check that the Propaq MD and AutoPulse Plus are properly connected. If APLS still does not appear, or a PADDLE FAULT occurs, discharge energy internally by changing the energy selection, disconnect the Multi-Function Cable and PADS from the AutoPulse Plus, and connect the Multi-Function Cable directly to the PADS.

When the Propaq MD is connected to the AutoPulse Plus device, the ECG signal will travel from the Electrodes, passing through the AutoPulse Plus and continue onto the Propaq MD unit. Similarly, a defibrillation shock can be sent from the Propaq MD unit, passing through the AutoPulse Plus, and continuing onto the Electrodes.

External Paddles



Paddles are defibrillation-proof Type BF equipment.

The external paddles on the Propaq MD device are used for defibrillation and synchronized cardioversion.

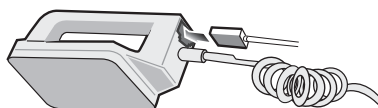
Caution

You cannot use paddles for external transcutaneous pacing.

Attaching the MFC cable

Attach the MFC from the Propaq MD unit to the connector at the base of the APEX paddle.

1. Align MFC as shown.



2. Insert MFC into APEX handle.

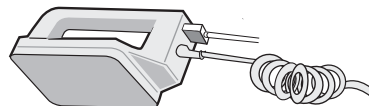


Figure 2-6. Attaching the MFC to the APEX Paddle

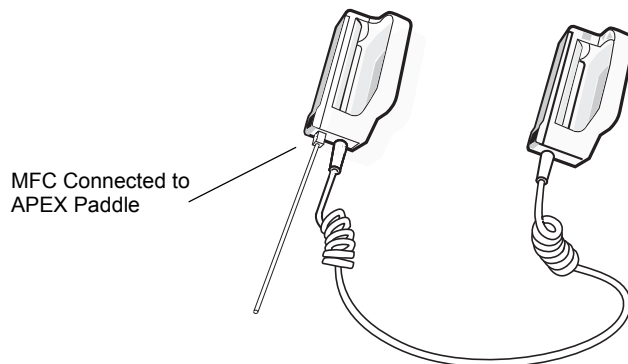
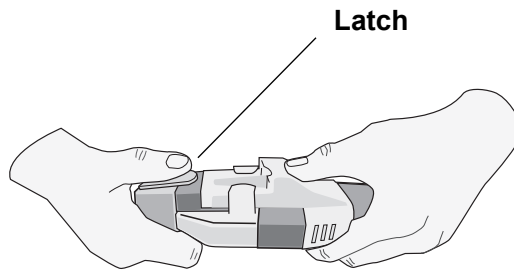


Figure 2-7. MFC Connected to APEX Paddle

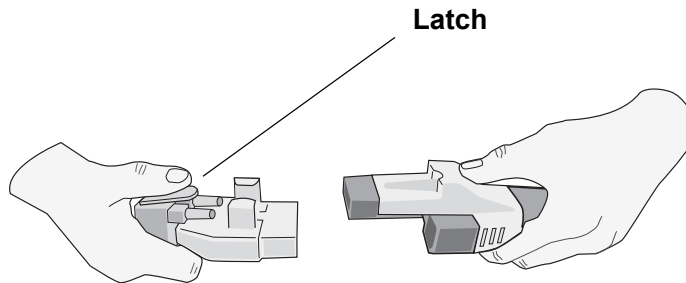
If you need to detach the MFC from the APEX paddles, push the **RELEASE** button (see Figure 2-10) in the direction of the arrow and unplug the MFC.

Attaching the OneStep Cable

When connecting a OneStep electrode to the OneStep cable, push the two connectors together until the latch clicks, as shown.

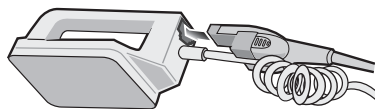


When disconnecting the OneStep electrode and OneStep cable, press down the latch with your thumb as shown.



When attaching the OneStep cables to paddles, attach the OneStep cable from the Propaq MD unit to the connector at the base of the apex paddle.

1. Align OneStep cable as shown.



2. Insert OneStep cable into APEX paddle.

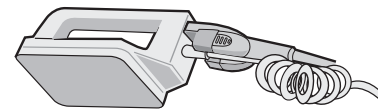


Figure 2-8. Attaching the OneStep Cable to the APEX Paddle

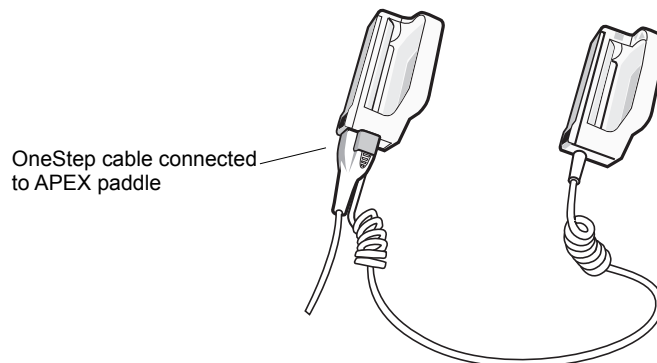


Figure 2-9. OneStep Cable Connected to APEX Paddle

If you need to detach the OneStep cable from the APEX paddles, push the **RELEASE** button (see Figure 2-10) in the direction of the arrow and unplug the OneStep cable.

Refer to , “Manual Defibrillation” before using paddles for defibrillation. The paddles include controls for selecting defibrillation energy, charging, and delivering a shock.

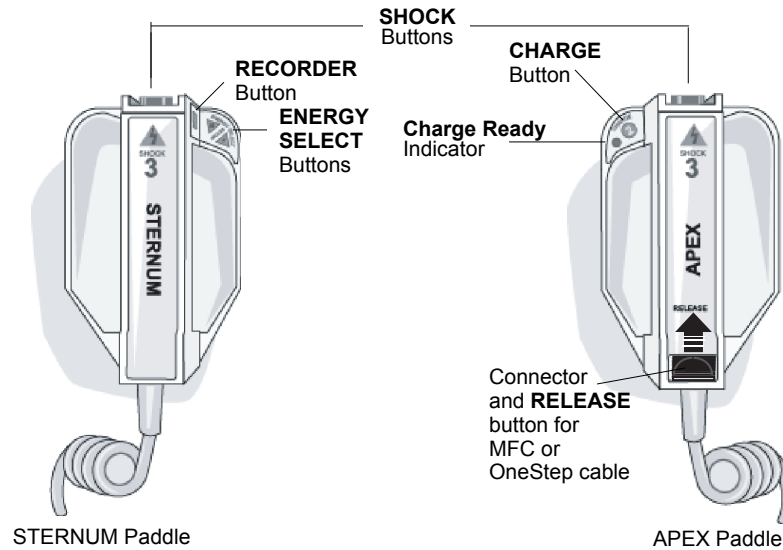
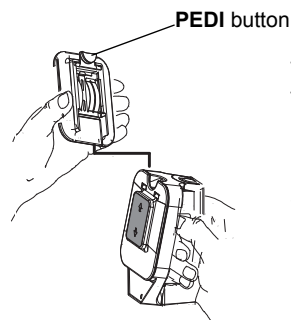


Figure 2-10. External Paddles

Pediatric-size electrodes are built in to the paddle assembly beneath the standard electrode plates. The user must manually adjust energy settings to pediatric levels consistent with their institution’s protocols.



To expose the pediatric plate, press the **PEDI** button at the top of the paddle, then slide the Adult plate upward.

Before replacing the Adult plate, be sure to clean the pediatric plate and surrounding area thoroughly.

Slide the Adult plate onto the paddle until it locks into place.

Figure 2-11. Pediatric Plate

Note: The Propaq MD defibrillator also supports ZOLL autoclavable internal handles for use during open chest defibrillation procedures.

Auxiliary Power Adapter

The auxiliary power adapter is used as backup power to operate the Propaq MD unit. When it is connected to the unit, it powers the unit and charges the battery that is installed inside it. When the power cord is plugged in and the auxiliary power connector is inserted into the back of the Propaq MD unit, the auxiliary power LED on the front panel illuminates and the auxiliary power icon displays at the top of the display screen.

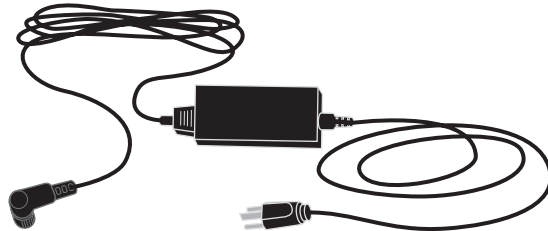


Figure 2-12. Auxiliary Power Adapter

Caution Allow access to AC power cord as a means of disconnecting from AC mains power.

To connect the auxiliary power adapter, align the white arrow of the auxiliary power cable with the white dot on the input connector on the back of the unit and push it in. To disconnect the auxiliary power adapter, grasp the connector and pull it out.

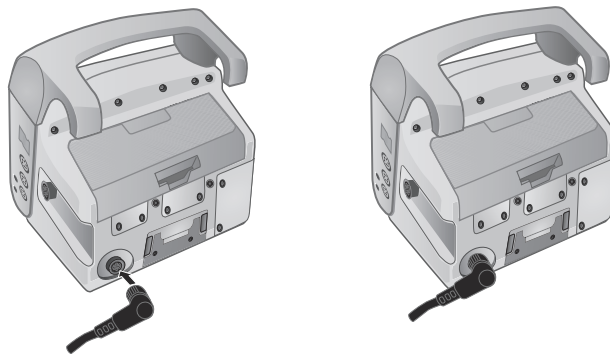


Figure 2-13. Connecting the Auxiliary Power Adapter

Navigating the Display Screen

You can access the Propaq MD functions using the quick access keys that are located on the left side of the display screen, and the navigation keys that are located on the right side of the front panel.

Quick Access Keys

The seven quick access keys on the left side of the display screen are an easy way to access the functionality of the Propaq MD. When you press the last key (left arrow), five more keys are displayed.

First level keys Second level keys

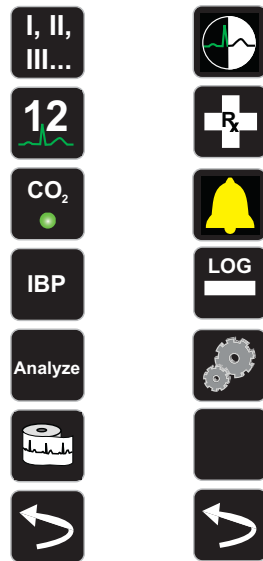


Table 2-3. Propaq MD Quick Access Keys






Quick access key	Description
Lead 	Selects the ECG input source for the first waveform trace.
12 lead 	Displays the 12-lead monitoring screen.
CO ₂ 	Turns CO ₂ on and off.
IBP 	Displays IBP setup and zero buttons.
Analyze 	Begins the analysis of the patient's ECG rhythm.

Table 2-3. Propaq MD Quick Access Keys































Quick access key	Description
Print 	Starts or stops a continuous chart print.
More/Back 	Goes to the next or previous level of quick access keys.
Brightness 	Changes the brightness setting -- toggles through high contrast display (white background), color display (black background), and night vision goggle (NVG) friendly display.
Treatment 	Displays the current clinical treatment options.
Alarms 	Displays the Limits option to allow the user to view/set all parameter alarm limits and the alarm suspend button.
Log 	Opens the Log Control panel.
Setup 	Displays the Setup menu to allow the user to configure settings such as ECG, display/volume, printer, trends, operational checklist, and supervisor.
Treatment Summary 	Displays treatment summary cases, which you can print.
Manual Mode 	Allows user to change from AED Mode to Manual Mode.
Pause 	Allows user to Pause the rescue cycle.
Print Trends 	Prints the trends that are displayed in the Trend Summary window.
Trend Settings 	Displays settings for trend display format, trend on interval, and trend on alarm.
Transfer Log 	Transfers the current data in the log to a USB drive.
Disclosure Log Transfer 	Use to transfer the Disclosure logs for up to 15 cases at a time to a remote server for subsequent retrieval.
Clear Log 	Deletes the current data in the log.
Acquire 	Collects 10 seconds of 12-lead data for print or transmission.

Table 2-3. Propaq MD Quick Access Keys

Quick access key	Description
Stop Acquisition 	Stops acquisition of 12-lead data.
Patient Information 	Allows you to enter information to accompany 12-lead data: patient name, age, gender, and ID.
Row Up 	Allows you to move to the previous row when entering patient information.
Row Down 	Allows you to move to the next row when entering patient information.
12-Lead Review 	Reviews all your 12-lead captured data.
12-Lead Review Next 	Goes to the next page of the 12-lead snapshot you are reviewing.
Transmit 	Transmits 12-lead data.
Exit 12-Lead 	Exits the 12-lead monitoring screen.
Stat Set 	Sets all alarm limits relative to the patient's current vital signs.
Alarm Cancel 	Pauses (suspends) alarm audio.
Limits 	Displays the current alarm settings.
Disarm 	Safely discharges the defibrillator internally. No energy is delivered to the patient.
IBP Setup 	Brings up the IBP Control Panel for the corresponding channel (P1, P2, or P3).
IBP Zero 	Zeroes the IBP transducer for the corresponding channel (P1, P2, or P3).

Navigation Keys

Use the navigation keys (up/clockwise arrow, down/counterclockwise arrow, and select button) to navigate through windows and make selections.

Using Up/Clockwise and Down/Counterclockwise Arrows

Use the up/clockwise down/counterclockwise arrows to do the following:

- Move clockwise and counterclockwise through the main display windows.
- Move up and down in a window.
- Change parameter settings.

Using the Select Button

Use the **Select** button to do the following:

- Display the settings window while a parameter is highlighted in the main window.
- Select options from a window.

Display Brightness

The monitor can display in two different brightness modes:

- high contrast with white background (for optimal display in bright sunlight)
- color with black background (numerics and waveforms are easy to read)
- night vision goggle (NVG) friendly (display and alarm LEDs prevent interference with goggles)

Common Tasks

The section contains procedures for the following tasks:

- “Setting the Date and Time” on page 2-21
- “Changing the Display Brightness” on page 2-22.
- “Replacing a Battery Pack on the Propaq MD” on page 2-23.
- “Using Treatment Buttons” on page 2-24

Setting the Date and Time

The Propaq MD Set Date and Time screen allows you to set the date the Propaq MD will use and its internal real time clock.

To set the Propaq MD unit’s date and time:

1. On the Propaq MD display screen navigate to and select the **Date and Time** field. The Set Date and Time screen displays.

Set Date And Time	
Month	04
Day	14
Year	2015
Hour	11A
Minute	16
Seconds	00
Set Date And Time	
←	

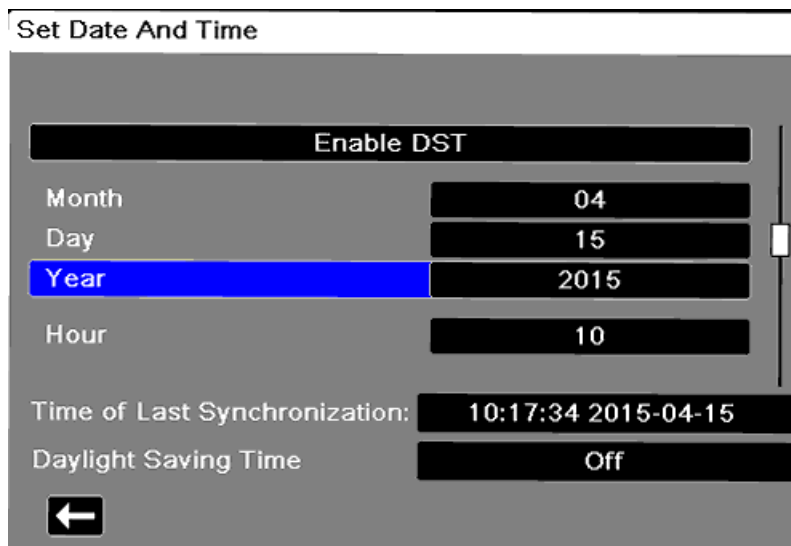
2. Specify the date by navigating to the date fields (**Month, Day and Year**) and adjusting as necessary.
3. Specify the unit’s time by navigating to the time fields (**Hour, Minute, Seconds**) and adjusting as necessary. The selections available in the **Hour** field depend on whether your unit is configured for a 12 or 24 hour (default) clock.

Note: For systems with Clock Synchronization enabled, avoid changing the unit’s time manually except at initial configuration.

4. When you are done indicating the date and time, select the **Set Date and Time** field to apply your selections.


Set Date and Time Screen with Clock Synchronization

For systems with the Clock Synchronization feature enabled, the Set Date and Time screen indicates the date and time of the last synchronization to an external time source and allows you to adjust the clock for Daylight Saving Time. You can choose whether to enable Daylight Saving Time or not by selecting the **Enable/Disable DST** field as appropriate. Adjustments to Daylight Saving Time take effect immediately and must be manually adjusted at every transition between Standard Time and Daylight Saving Time. If enabled the clock will be adjusted forward by 1 hour. These fields only display on systems with the Clock Synchronization feature enabled. For information on Clock Synchronization, see “Configuring Clock Synchronization” on page 22-32.



Changing the Display Brightness

The following procedure shows how to select the different brightness options.

1. Press the power switch to turn the unit on.
2. Press the **Brightness** quick access key () repeatedly to toggle through the brightness options until you find your selection.

Note: Selecting a higher brightness setting (such as 70%) will deplete the battery pack at a faster rate than when choosing a lower brightness setting (such as 30%). To select the brightness setting, go to the Setup>Display/Volume>Display Brightness menu to adjust the display percentage.

Replacing a Battery Pack on the Propaq MD

This section describes how to replace a battery pack on the Propaq MD.

Replacing a Battery Pack on the Propaq MD

To remove a battery pack, use your fingers to grasp and raise the latch and pull the battery pack out of the compartment.

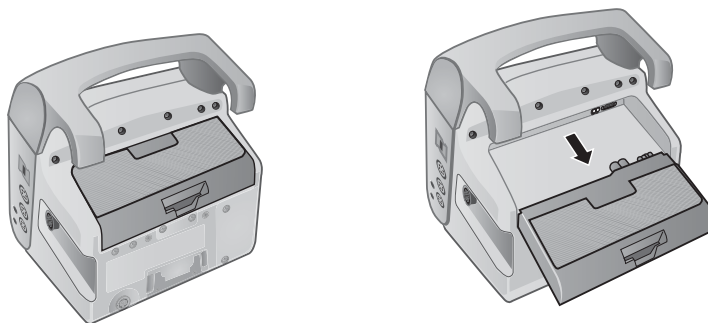


Figure 2-14. Removing a Battery Pack

To install a battery pack:

1. Line up the battery so it will slide into the battery well.
2. Push the battery into place.

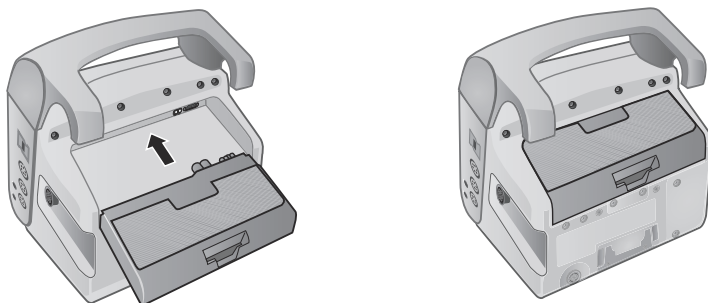




Figure 2-15. Installing a Battery Pack

Using Treatment Buttons

Pressing the **Treatment** quick access key () causes the unit to display preconfigured buttons that contain clinical actions. These buttons allow you to add a treatment snapshot (which itemizes drugs or treatments administered to the patient) to a Treatment Summary Report. You can do this by selecting **Print on Treatment Snapshot** from Setup>Supervisor>Printer. The following is a list of preconfigured treatment buttons:

- O2
- ASA
- Nitro
- Morph
- IV
- B Block
- Lido
- MgSO4
- Valium
- Sedate

Customizing Treatment Buttons

You can also customize up to 9 treatment buttons by pressing the Setup quick access key () and then selecting Supervisor>Log>Treatment Options. Highlight **Define Custom Labels**, and then can customize up to 9 buttons.

Chapter 3

Monitoring Overview

This chapter provides an overview of the Propaq MD unit's monitoring functions. It describes the types of vital sign monitoring that Propaq MD provides, and the flexibility that the Propaq MD unit gives you in displaying a patient's vital signs information.

Propaq MD Monitoring Functions

The Propaq MD unit provides an array of standard, and optional, monitoring functions, and allows you to view the vital signs measurements that these functions provide in a variety of formats. The Propaq MD unit also allows you to set alarm limits for each monitoring function. Should a patient's vital signs measurements go outside of these limits, the Propaq MD issues an audible alarm tone and displays visual alarm indications to alert you.

If the Propaq MD unit is powered off for less than 2 minutes, all patient monitoring parameter settings are retained. If the Propaq MD unit is powered off for 2 minutes or longer, the unit operates as if there is a New Patient and all patient-specific parameters (alarm limits, defibrillator energy, etc.) are reset to their default values.

The Propaq MD unit can monitor the following patient vital signs:

- ECG
- Heart Rate
- Respiration Rate
- Temperature
- Invasive Pressures (IBP)
- Non-invasive Blood Pressure (NIBP)
- Capnography (CO₂)
- Pulse Oximetry (SpO₂)

ECG

An ECG waveform trace appears at the top of the display area. You can specify that the unit display the waveform trace of any available ECG source, such as **Pads**, ECG Leads **I**, **II**, or **III**, and so on, in this area. You can configure the Propaq MD unit to display up to four ECG waveform traces. In addition to being able to specify the ECG source for each waveform trace, you can adjust the display scale of those traces to make them easier to view.

Heart Rate

A Heart Rate meter gives the patient's heart rate in Beats Per Minute (**bpm**). By default, the Propaq MD unit derives the heart rate from the patient's ECG, but can be configured to use other monitoring functions to derive the patient's heart rate.

Respiration Rate

A Respiration Rate meter gives the patient's respiration rate in Breaths Per Minute (**br/min**). The Propaq MD unit can be configured to derive the respiration rate from the patient's ECG or from the optional CO₂ monitoring function.

Temperature

The Temperature (**Temp**) meter can display temperature measurements from up to two temperature probes. The Propaq MD unit provides two separate temperature monitoring channels and, if both are used, displays the monitored temperatures, in degrees F or C, one after the other, followed by the difference between those temperatures.

Invasive Pressures (IBP)

The Propaq MD unit provides three separate channels for monitoring arterial, venous, or intracranial pressure using internal probes. The pressure measurements for each pressure channel appear in a labeled (**P1**, **P2**, **P3**) numeric display.

Non-Invasive Blood Pressure (NIBP)

The Propaq MD unit provides patented Smartcuf motion-tolerant technology for NIBP monitoring. NIBP monitoring measures the patient's systolic, diastolic, and mean blood pressure through an inflatable blood pressure cuff that the Propaq MD unit inflates/deflates. NIBP measurements can be taken automatically or on-demand by pressing the **NIBP** button (☞) on the front panel of the Propaq MD unit. The blood pressure measurements appear in a labeled (**NIBP**) numeric display. You can also specify that the Propaq MD unit display non-invasive pressure waveforms in the waveform trace area.

Capnography (CO₂)

CO₂ monitoring measures the CO₂ concentration in a patient's exhaled breath (End Tidal Carbon Dioxide --EtCO₂). CO₂ monitoring can also measure a patient's breath rate and the CO₂ concentration in the gasses supplied to intubated patients (Fractional Inspired Carbon Dioxide -- FiCO₂). Since FiCO₂ represents the amount of CO₂ present during inhalation, it also serves as an indicator for rebreathing in non-intubated patients. CO₂ monitoring can be used for both intubated and non-intubated patients.


The EtCO₂, breath rate, and FiCO₂ measurements appear in a labeled (**EtCO2**) numeric display. The EtCO₂ and FiCO₂ measurements can appear as values given in millimeters of mercury (mmHg). You can also specify that the Propaq MD unit display a CO₂ capnogram in the waveform trace display area.

Pulse Oximetry (SpO₂)

Pulse Oximetry monitoring measures the oxygen saturation (SpO₂) of arterial blood at a peripheral site such as a finger or toe. If the optional features SpCO (carboxhemoglobin saturation) and SpMet (methemoglobin saturation) or SpHb (total hemoglobin), SpOC (oxygen content), PVI (pleth variability index) and PI (perfusion index) are installed, the Propaq MD unit also monitors these parameters.

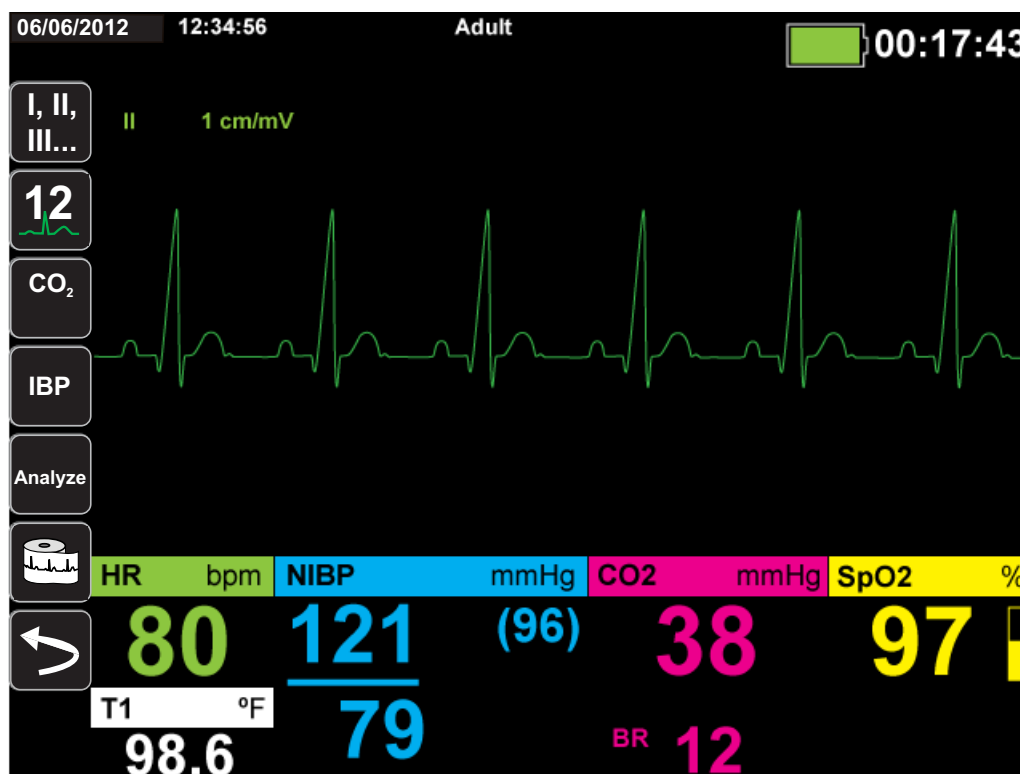
SpO₂ monitoring determines the ratio of oxygenated hemoglobin to total hemoglobin in arterial blood and displays this ratio as percent SpO₂ in a labeled (**SpO2**) numeric display. If the optional features SpCO and SpMet or SpHB, SpOC, PVI and PI are installed, these values alternate and display under the SpO₂ display. You can also specify that the Propaq MD unit display an SpO₂ plethysmograph in the waveform trace display area.

Monitoring Display Options

The Propaq MD unit gives you great flexibility in how you display a patient's vital signs information. By pressing the **Display/Home** button () on the front panel, you can successively display the patient's vital signs information in these three windows:

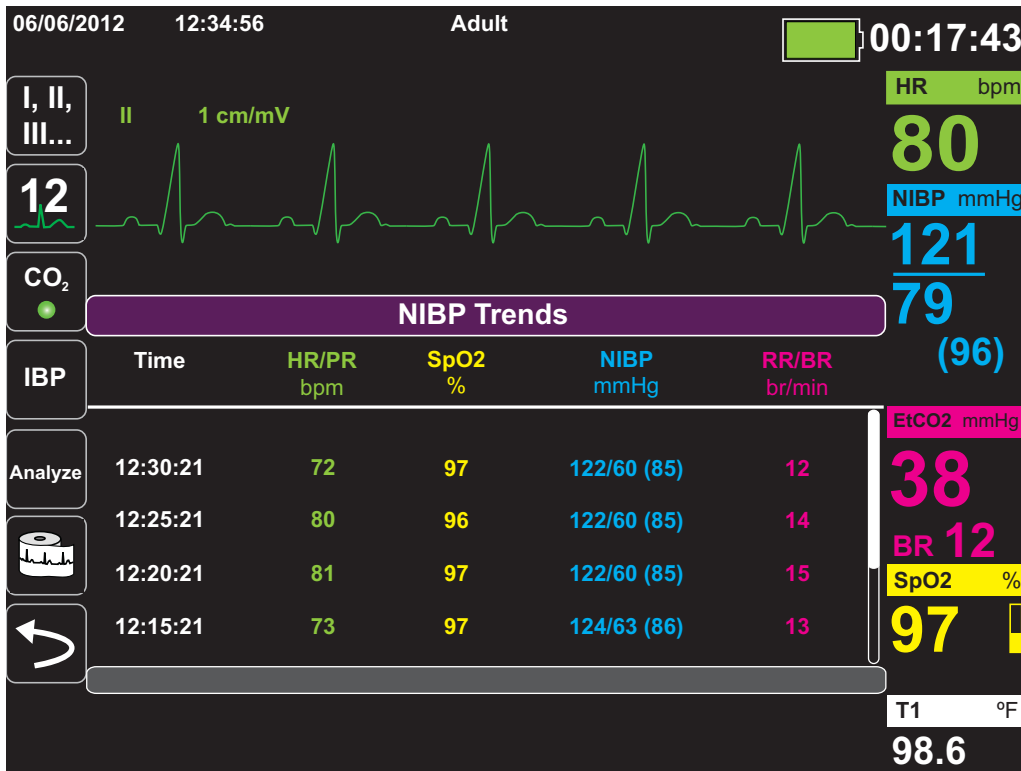
- **Waveform Display window**, which initially displays an ECG waveform trace and numeric displays for each monitoring function.
- **Trends Status window**, which displays a report listing vital signs measurements that the Propaq MD unit logs automatically, and the primary ECG waveform trace.
- **Large Numerics Display window**, on which large numeric displays of all vital signs measurements appear.

The Waveform Display window appears when you power on the Propaq MD unit. Initially, the Waveform Display window displays a single ECG waveform trace. All other monitored values appear in numeric display areas at the bottom of the screen:

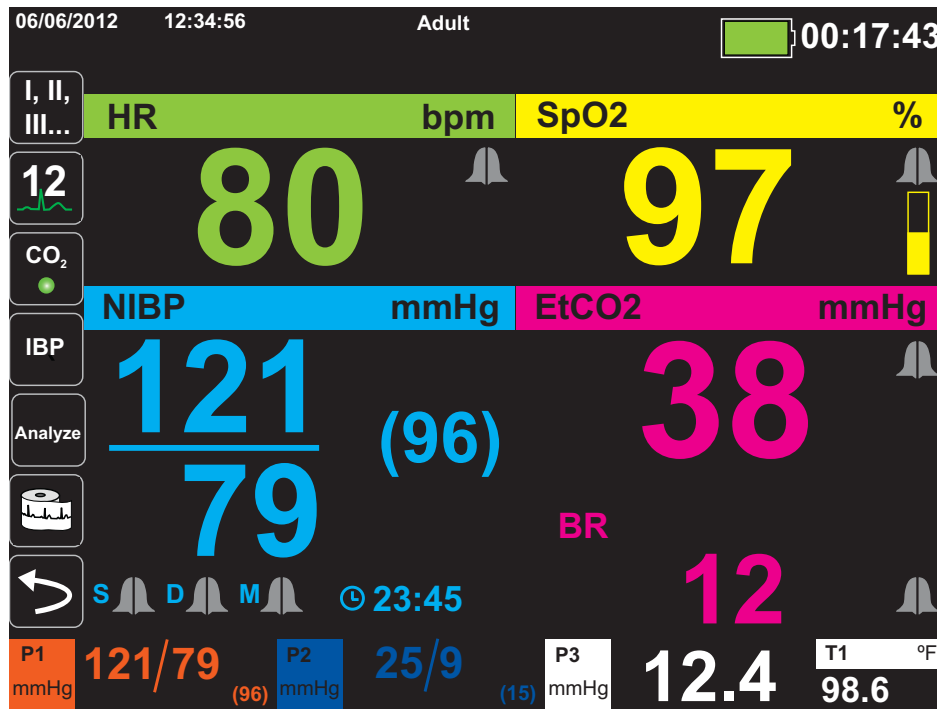


You can display up to four waveform traces that you specify on the Waveform Display window. You will determine how to add waveform traces to this window later in this chapter.

Press the **Home/Display** button when viewing the Waveform Display window, and the unit displays the Trends Status window. The Trends Status window reports the patient’s vital sign measurements, which the Propaq MD logs automatically at a configurable interval (see the following chapter, *Trends*, for more detailed information about the Trends Status window). The primary ECG waveform trace appears above the Trends report:



Press the **Home/Display** button when viewing the Trends Status window and the Large Numerics Display window appears. The patient's vital signs measurements appear in large labeled numeric displays; no waveform trace appears on this screen:



Press the **Home/Display** button to redisplay the Primary Display window.

Note: When the Propaq MD unit is displaying the Defibrillation or Pacing Control panels, the unit will not allow the display the Large Numerics Display window.

Configuring the Waveform Display

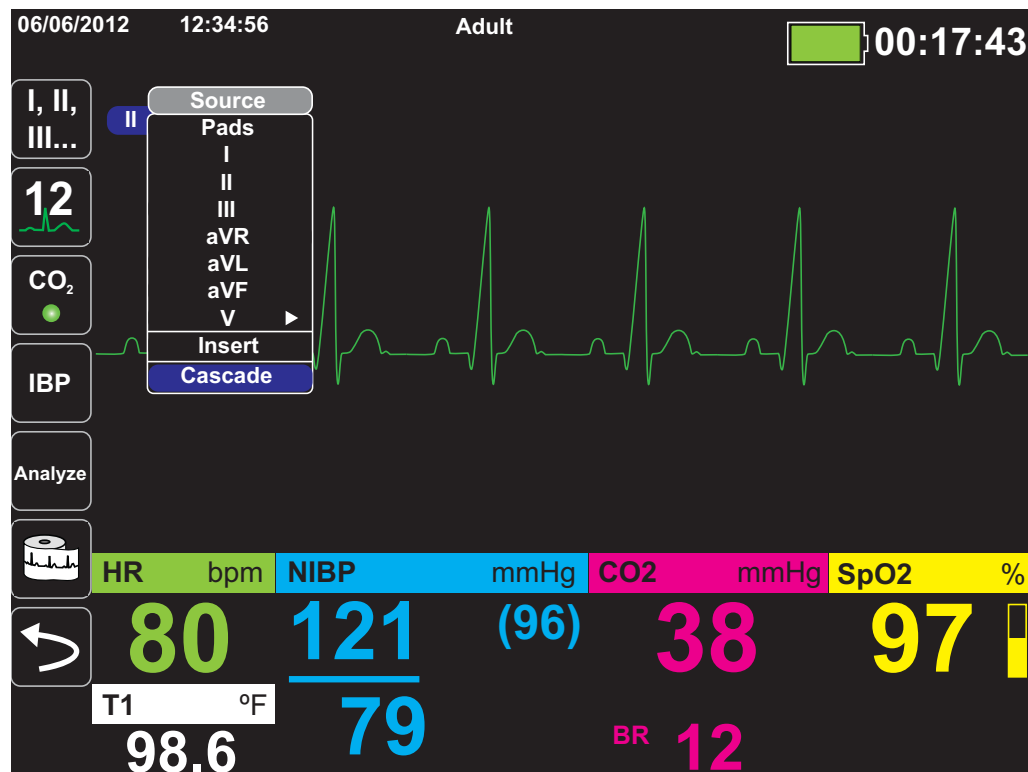
You can display up to four waveform traces on the Waveform Display window. The first waveform trace always uses an ECG lead as its source (such as **Pads** or Leads **I, II, or III**, and so on. The default is **Pads**). If **Pads** are not connected, the unit can be configured to automatically default to another ECG lead for the first trace. As you insert the remaining three traces, you can specify that the traces use an ECG lead as the waveform source, or that the trace derive its waveform from other available monitoring functions (such as **Resp**, **CO2**, **SpO2** or IBP channels **P1**, **P2**, or **P3**).

Note: For Propaq MD units with the AutoPulse Plus option available, the text APLS displays next to the first waveform trace in place of Pads when the Propaq MD unit is connected to pads through an AutoPulse Plus.

If configured, the unit can display four ECG traces on startup, when no other monitoring devices are attached.

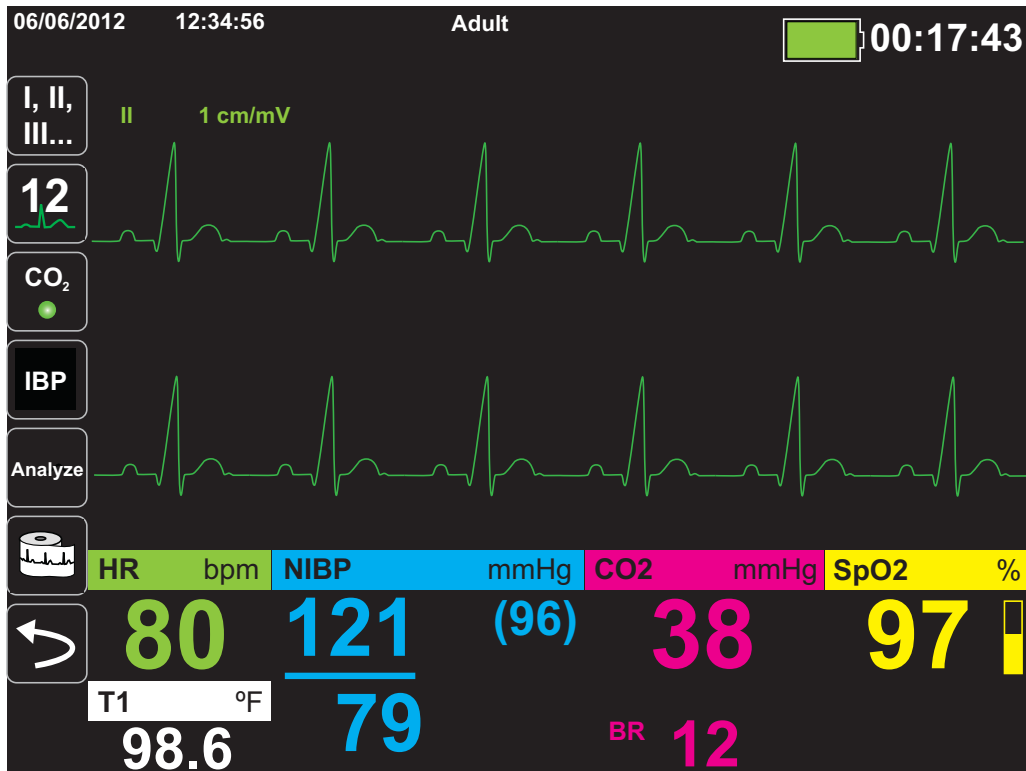
The Propaq MD unit can also cascade a trace onto the adjoining trace area to double the duration of the trace display.

On the Waveform Display window, to insert a new trace (**Insert**) or cascade (**Cascade**) a displayed trace, highlight and select the trace label above the trace. In the following example, the unit is configured to cascade the ECG Lead I trace:



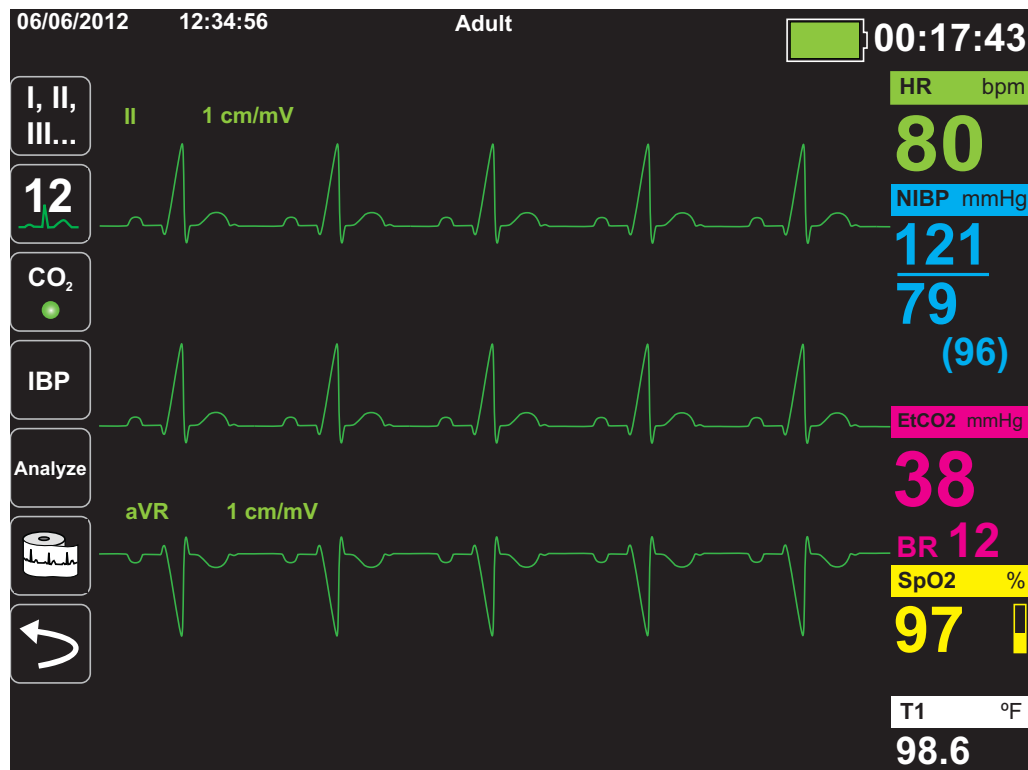
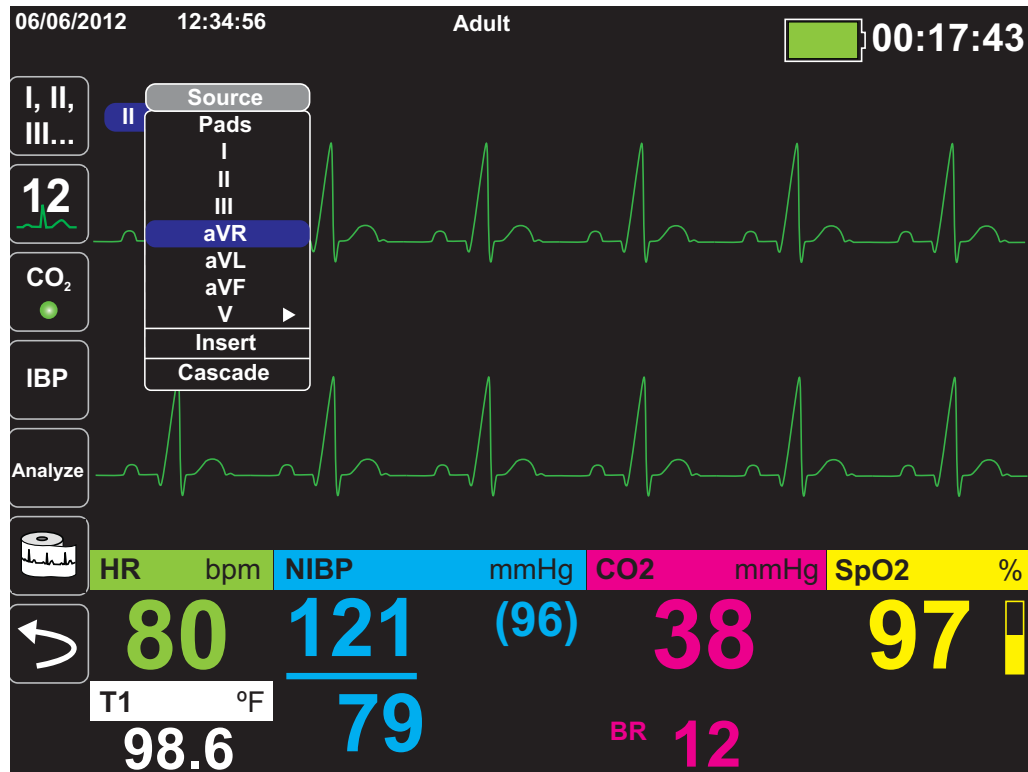
Note: The Propaq MD unit automatically inserts a new waveform when you turn on a parameter (CO₂) or a new sensor signal is present (SPO₂, IBP). The Propaq MD unit automatically removes a waveform when you turn off a parameter or remove a sensor and the unit displays the resulting equipment alert.

When the unit cascades the ECG Lead II trace, the Waveform Display window appears as follows:

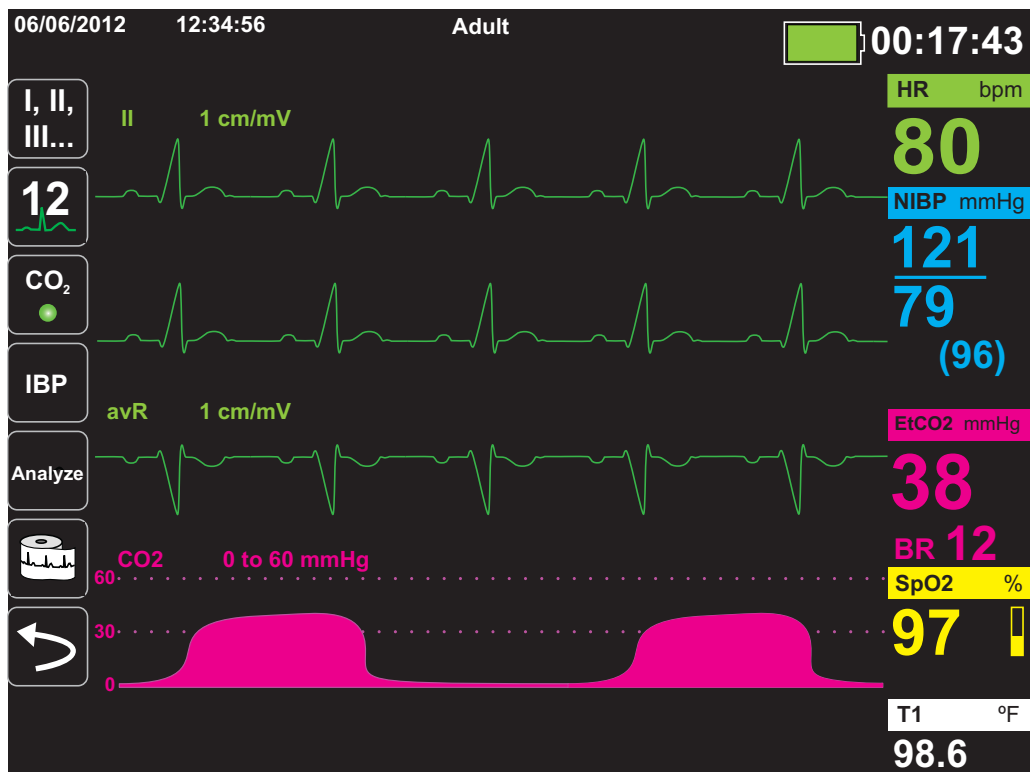


The following screens demonstrate how to insert two more waveform traces into the window. A third trace is inserted for ECG lead **aVR**, and fourth trace for **EtCO2** (a capnogram). Notice that when the third trace is inserted, the numeric displays move to the right side of the window to allow more room for the waveform traces.

Inserting a third waveform trace for ECG lead **aVR**:




Inserting a capnogram (CO₂) into the fourth trace area:



Chapter 4


Trends

The Propaq MD unit accumulates a patient's trend information by logging all monitored vital sign measurements to memory at a user-configurable interval. It also logs *all* monitored vital sign measurements when the following occurs:

- An NIBP measurement is taken and the **Trend on NIBP** option is on
- You press the **Snapshot** button () on the front panel
- A patient alarm occurs and the **Trend on Alarm** option is on

The Propaq MD unit can store at least 24 hours of trend information when logged at a 1 minute trend interval. You can view, print, or save to external memory all logged trend information.

Displaying the Trends Status Window

The Propaq MD unit displays the logged trend information in the Trends status window. Press the **Display/Home** button () to display the Trends window, the primary ECG trace, and the small numeric displays for each monitoring function:

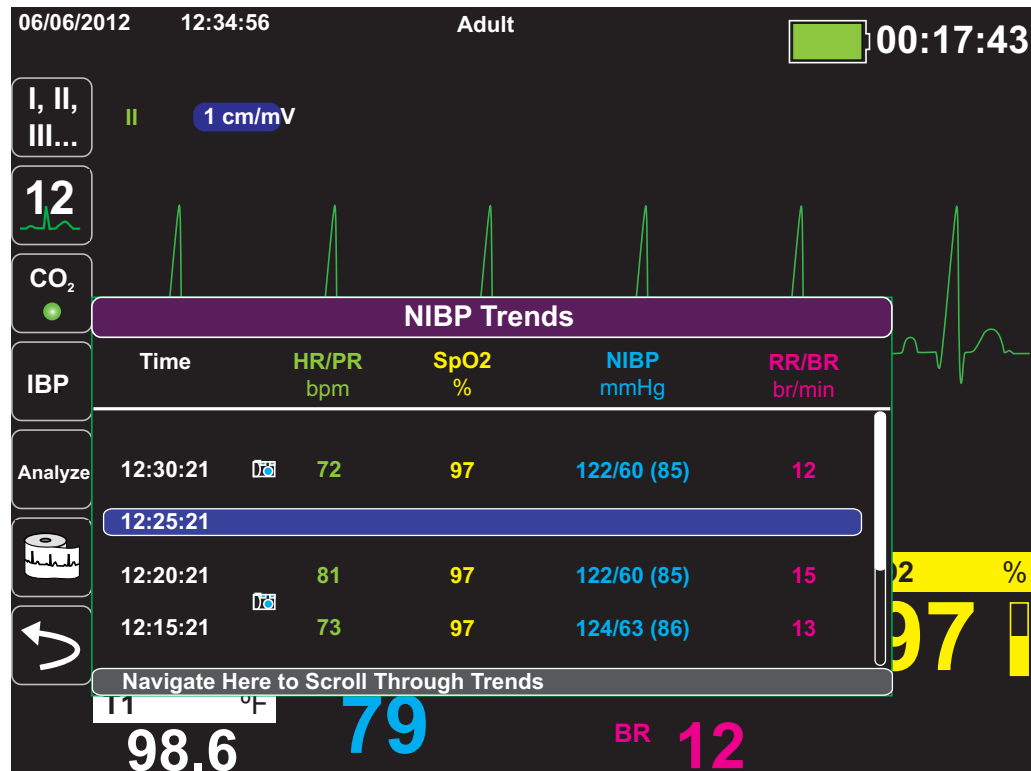



Figure 4-1 Trends Status window

The Trends status window displays the logged trend information and the time at which the trend measurements were logged. While trend measurements are logged to memory at a 30-second interval, the Trends status window can display the logged information at an interval that you specify, with the exception of NIBP measurements, which are logged and reported at the times they are taken. The Trends status window reports the trends information at 5-minute intervals.

To navigate in the Trends status window:

1. Use the navigation keys to highlight the **Navigate Here to Scroll Through Trends** bar, then press **Select**.
2. Press the **Up/Down** buttons () to scroll through the trend information.

Printing Trend Information

Printed trends are useful for reviewing the patient's vital signs over the last several minutes to the last five hours. You can print vital signs data at one selected time or a trend summary showing vital signs values acquired during the current case (up to the last 24 hours).



Printing Trend Summary

To print a trend summary of all trends for the current patient:

1. Use the navigation keys to highlight the **NIBP Trends** field and press **Select**. The Trend Settings menu displays. Highlight the **Print Trend Summary** field and press **Select**. The Trend Summary Report begins printing.
2. To cancel the report, highlight **Cancel Report** and press **Select**.

Printing The 10 Most Recent Trend Snapshots

To print the 10 most recent trends for the current patient:

1. Press the **Log** quick access key () then press the **Print Trends** button (). The Trend Summary menu displays.
2. Navigate to and select the **Select 10 Most Recent** button.
3. Navigate to and select the **Print Trend Summary** button. The 10 most recent trends print for the current patient.



Printing an Individual Trend Snapshot

To print an individual trend snapshot:


1. Highlight the **Press the Select Button to Start Scrolling** at the bottom of the Trends window and press **Select**.
2. Using the navigation keys, select the trend snapshot you want to print and press **Select**.
3. Highlight **Print this Trend** and press **Select**. The trend snapshot begins printing.



Printing Specific Trend Snapshots

To print a trend summary for one or more cases:

1. Press the **Log** quick access key () then press **Print Trends** (). The Trend Summary menu displays.
2. Use the navigation keys to select the case or cases you want to print and press **Select**. A check mark displays next to the selected case(s).
3. Highlight the **Print Trend Summary** field and press **Select**. The trend data for all the selected cases begins printing.


Changing the Trends Status Window Display

By default, the Trends status window displays all logged trend information. It displays the numeric information for all monitoring functions, which the unit logs at a 30-second interval, and when you take NIBP measurements, when a patient alarm occurs, and when you press .

To configure the display of the Trends status window, press () and press the **Trend Settings** quick access key () to display the Trends Settings control panel. On the Trends Settings control panel, select **Trend Display Format** to specify the following monitored vital signs that appear in the Trends status window:

Trend Format	Vital Signs Displayed
Resp	HR, SpO2, RR, EtCO2, FiCO2
SpO2	HR, SpO2, SpCO, SpMet
SpHb	HR, SpO2, SpHb, SpOC, PVI
NIBP	HR, SpO2, NIBP, RR
IBP1	HR, SpO2, IBP1, RR
IBP2	HR, SpO2, IBP2 RR
IBP3	HR, SpO2, IBP3, RR
Temp	HR, SpO2, T1, T2, ΔT

Continuous Waveform Recording

Continuous waveform recording allows you to record continuous waveforms to a full disclosure case log for the patient being monitored. This feature needs to be enabled by a supervisor. The supervisor can access this feature by pressing the **Setup** quick access key () and then selecting Supervisor>Log>Waveform Recording. In this menu, the following settings can be customized:

- **Record Displayed Waveforms** – Record only the top waveform that is displayed or record all waveforms that are displayed.
- **Record Additional Waveforms** – Always record the CO₂ waveform or always record the IBP and the CO₂ waveforms.

There is an additional waveform that can be enabled in the Waveform Recording menu. This option, **Record Pads Imp. Waveform**, measures the patient's impedance between defibrillation electrodes.

Note: When Continuous waveform recording is disabled, no waveforms (except snapshots) are recorded.

The full disclosure case can, at a minimum, concurrently store the following information:

- 32 monitor snapshots
- 500 non-ECG events
- 24 hours of continuous ECG (4 waveforms), Capnography, IBP (3 channels), and Pads Impedance

The actual information that is stored depends on usage. Also, the specific combination of stored continuous waveform data depends on how the waveform recording settings are configured in the Supervisor menu.

Chapter 5

Alarms

The Propaq MD unit supports the detection and indication of *patient alarms* and *technical alerts*.

A patient alarm is any alarm condition that is caused by a monitored patient-related variable, such as a measured vital sign that falls outside of a configured alarm limit. *You can configure patient alarm limits for each of the physiologic monitoring functions.*

A technical alert is monitored equipment-related variable that the Propaq MD unit can detect, such as a disconnected sensor, internal diagnostics failures, and so on. *Technical alerts are always enabled and are not user-configurable.*

Patient alarms are always classified as high-priority alarms. Urgent technical alerts are classified as medium priority alarms. Other equipment status messages are classified as information signals.

Alarm conditions from patient alarms and technical alerts are stored in the Event Log and retained with normal power down or total loss of power.

Visual Alarm Indicators

In addition to status messages that appear on the display, the Propaq MD unit lights the red or yellow LED on the front panel to indicate the priority level of the highest-priority active alarm. The Propaq MD LEDs indicate the priority level of the highest-priority active alarm as shown in the following table.

Active Alarm/Alert Priority	Visual Alarm/Alert Indicator
High Priority -- Patient Alarm	Flashing Red LED
Medium Priority -- Technical Alert	Flashing Yellow LED
Information Signal; -- Equipment Status Message	Visual message only. No LED indicator

Audible Alarm Indicators

The Propaq MD unit sounds an audible alarm to indicate the priority level of highest-priority active alarm. The Propaq MD indicates the priority level of the highest-priority active alarm by sounding the audible alarm tones described in the following table.

Active Alarm/Alert Priority	Audible Alarm/Alert Indicator	Alarm/Alert Volume (measured in accordance with ISO 3744)
High Priority -- Patient Alarm	Two sets of five short beep tones, repeated at 15-second intervals	Adjustable range: Maximum Level \geq 69 dB(A) Minimum Level \geq 61 dB(A)
Medium Priority -- Technical Alert	One set of three longer beep tones, repeated at 30-second intervals	Adjustable range: Maximum Level \geq 66 dB(A) Minimum Level \geq 59 dB(A) Volume is 3 to 12 dBA below high priority alarm
Information Signal-- Equipment Status Message	A single short beep tone, not repeated	Volume is at least 6 dBA below the medium priority alert

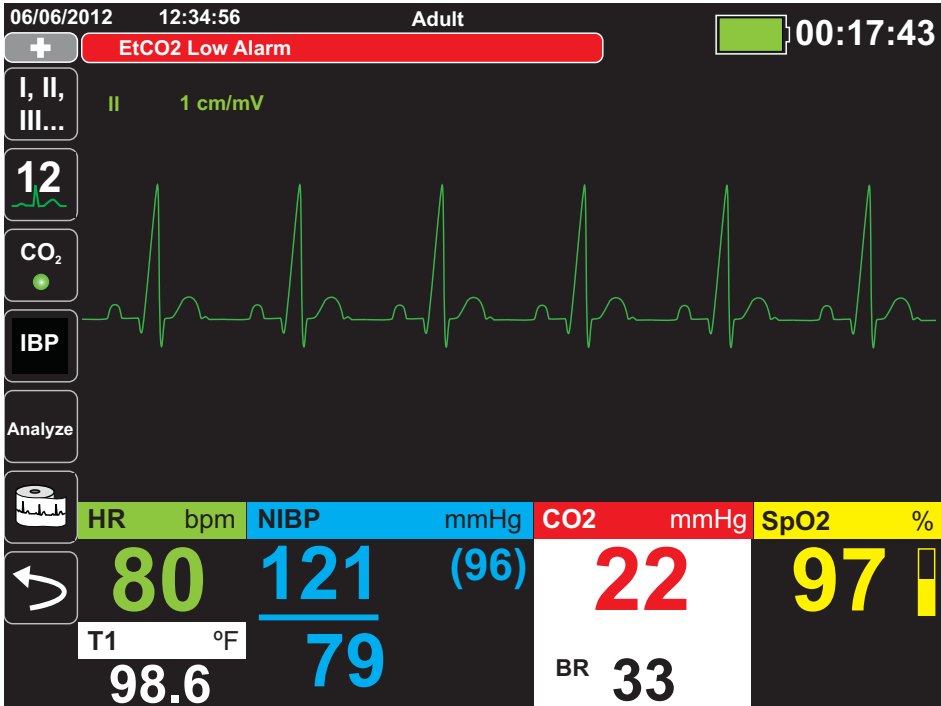
Alarm Indicator Self-Test

The Propaq MD unit performs a self-test of the audio and visual alarm indicators upon power-up. To ensure that the alarms and alerts are functioning properly, verify that two alarm tones are heard and the green, yellow, and red LEDs are illuminated upon power up.

Patient Alarm Display

When a patient’s vital signs measurements trigger an alarm, in addition to sounding the patient alarm, the Propaq MD unit displays an alarm message, and changes the display characteristics of the monitoring function’s numeric display (the alarming parameter appears in red against a white background).

In the following example, the EtCO₂ measurement (**22** mmHg) has dropped below the lower alarm limit (**EtCO₂ Low Alarm**):



Life Threatening Rhythm Alarms

When LTA monitoring is enabled, the Propaq MD will monitor for the following life threatening ECG rhythms: asystole, ventricular fibrillation, ventricular tachycardia, extreme bradycardia, and extreme tachycardia.

Depending upon configuration of the unit, it generates visible and audible alarms as needed.

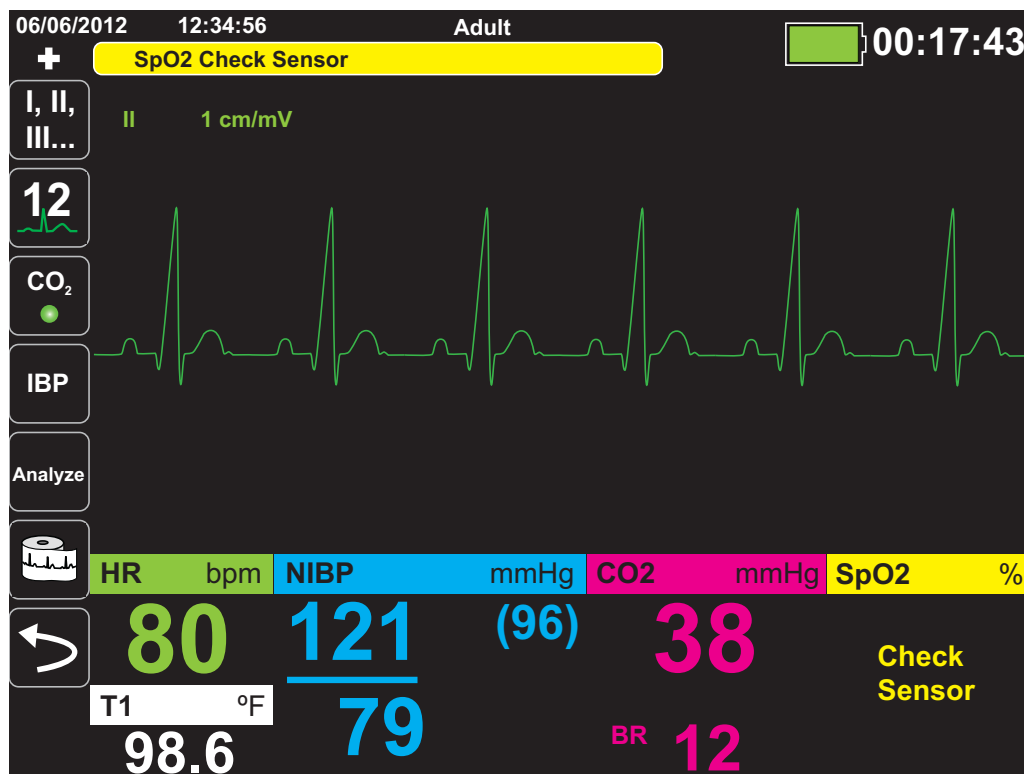
Note: LTA monitoring is not available in AED mode.

Equipment Alert Display

When a problem with the Propaq MD unit or an attached sensor triggers an alert, in addition to sounding an equipment alert, the Propaq MD unit displays an alert message (yellow background, black text).


Warning! Always respond immediately to a system alarm since the patient may not be monitored during certain alert conditions.


In the following example, an equipment alert message indicates that the SpO₂ sensor has become unattached (**SpO₂ Check Sensor**) from the unit:




Responding to Active Alarms -- Silencing the Alarm

When a patient alarm is triggered and the alarm tone sounds:

1. Check the patient and provide appropriate care.
2. Press the **Alarm Pause/Reset** () button on the Propaq MD unit's front panel to acknowledge the alarm and briefly pause (silence) the alarm (90 seconds).
3. After caring for the patient, check that the appropriate alarms are set (for more information about setting alarms, see appropriate monitoring chapters later in this manual).

Note: Pressing the **Alarm Pause/Reset** () button pauses (silences) the alarm tone briefly for all active alarms. If the patient's vital signs measurements trigger another, different alarm, the patient alarm tone will sound, even if the first pause (silence) period hasn't expired.

Re-enabling an Alarm

To re-enable an alarm before the alarm pause (silence) period has expired, press the **Alarm Pause/Reset** () button.

-
- Warning!**
- Do not pause (silence) the audible alarm if patient safety may be compromised.
 - Do not adjust alarm signal volume lower than the ambient noise level if this may impede operator recognition of alarm signals.
-

Latching Alarms

High priority patient alarms can be configured to be latching or non-latching (default). When alarms are configured to be latching, alarm indicators (sound, message, color) remain whether or not the condition is present. Life Threatening Rhythm Alarms (LTA) are always latching. Latched alarms must be acknowledged even if the condition no longer exists. Latching alarms are useful in situations where the patient may not be continuously attended by the clinical operator as they make you aware of patient alarm conditions whether or not they are still occurring.







When alarms are configured as non-latching alarm indicators clear when the alarm condition ends, whether or not the alarm was Paused (Silenced).


Latching alarms are enabled or disabled (default) in the Setup>Supervisor>Alarms>General>menu.

Pausing (Suspending) Alarms

If you want to temporarily prevent potential or current patient alarms and equipment alert alarms from sounding when caring for a patient, you can pause (suspend) alarm audio for 2, 4, or 15 minutes (depending on your unit configuration) or you can pause (suspend) the alarm audio indefinitely (Audio Off). Alarms automatically resume after the configured pause (suspend) time is up.

To pause (suspend) patient alarms:

1. Press the **More** quick access key () to access the second set of quick access keys.
2. Press the **Alarms** quick access key ().
3. If you would like to pause (suspend) alarms for the configured amount of time, press  quick access key once. The Alarm Audio Paused icon ( 14:55) appears at the top of the display next to the message area along with a timer indicating the amount of time the alarms will be paused.
4. If you would like to turn the alarm audio off indefinitely, press the  quick access key a second time. The Alarm Audio Off icon ( On) appears on the top of the display next to the message area to indicate alarm audio is paused indefinitely for this unit.

Note: Press the  quick access key a third time to clear the display and resume alarm audio.

No alarms will sound while alarms are paused (suspended); however, if an alarm occurs during the suspension period, the Propaq MD unit will display visual alarm indicators -- alarm messages in the message area (white text on a red background) and red/white numeric displays).

Note: Your Propaq MD unit may be set up to not allow pausing (suspending) alarms.



Warning! When audible alarms are disabled, make sure that the patient is closely observed.

Alarm Reminders

Your Propaq MD unit may be configured to sound a Reminder Alarm at specified intervals. When the Reminder Alarm is enabled an alarm will sound every 5 (default), 10 or 15 minutes (depending on configuration) if an Audio Off condition persists. When Reminder Alarm is disabled, no reminders are issued if the Audio Off condition continues. You enable or disable the Reminder Alarm in the Setup>Supervisor>Alarms>General>menu.

Alarm Options

The Propaq MD unit provides alarm options that you can specify through the Supervisor parameter control panel (access to Supervisor is passcode-controlled).

Press the **More** quick access key () , press the **Setup** quick access key () , and select **Supervisor**. Using the navigation keys, select the four digits in the Supervisor passcode. Press **SAVE** when you are finished. Once you have entered your supervisor passcode, you will be able to access the configurable options in the Supervisor menu.

Select **Alarms** to display the alarms parameter control panel:

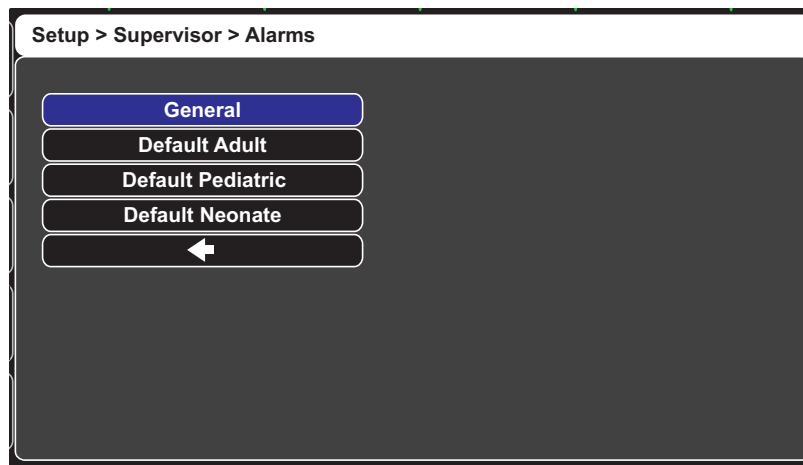


Figure 5-1 Alarms Parameter Control Panel

Selecting Default Alarm Limits

The three options -- **Default Adult**, **Default Pediatric**, **Default Neonate** -- allow you to set *all* alarm limits to the Propaq MD unit's factory-specified default values, by patient type.

-
- Warning!**
- A potential hazard exists if different alarm limits are used for the same or similar equipment in any single area.
 - **Confirm the alarm limits are appropriate for the patient each time there is a new patient case.**
 - **Do not set alarm limits to such extreme values that render the alarm system useless.**
-

Setting Alarm Limits Relative to the Patient -- Stat Set Option

The Propaq MD unit also allows you to set all alarm limits relative to the patient's current vital signs measurements by performing the following actions:

1. Press .
2. Press the **Alarm** quick access key (.
3. Press the **Stat Set** quick access key (). The Propaq MD unit sets all parameters to a new value based on the current values as follows:

Parameter (units)	Range	Upper Limit Calculation	Lower Limit Calculation	
HR/PR (bpm)	Numeric < 26	Limit is unchanged	Limit = 25	
	$26 \leq \text{Numeric} \leq 99$	Limit = Numeric x 1.2	Limit = Numeric x 0.8	
	$100 \leq \text{Numeric} \leq 250$	Limit = Numeric + 20	Limit = Numeric - 20	
IBP (mmHg)	Numeric > 250	Limit = 250	Limit is unchanged	
	Numeric < 26	Limit = Numeric + 5	Limit = Numeric - 5	
	$26 \leq \text{Numeric} \leq 99$	Limit = Numeric x 1.2	Limit = Numeric x 0.8	
NIBP (mmHg)	Numeric > 99	Limit = Numeric + 20	Limit = Numeric - 20	
	Numeric < 26	Limit = Numeric + 5	Limit = Numeric - 5	
	$26 \leq \text{Numeric} \leq 99$	Limit = Numeric x 1.2	Limit = Numeric x 0.8	
RR/BR (/min)	Numeric > 99	Limit = Numeric + 20	Limit = Numeric - 20	
	Numeric < 26	Limit = Numeric + 5	Limit = Numeric - 5	
	$26 \leq \text{Numeric} \leq 99$	Limit = Numeric x 1.2	Limit = Numeric x 0.8	
SpO₂ (%)	Numeric > 99	Limit = Numeric + 20	Limit = Numeric - 20	
	Entire range	Limit = 100 (Adult and Pediatric) Limit = Numeric + 5 (Neonate)	Limit = Numeric - 5	
	SpCO (%)	Entire range	Limit = Numeric + 2 Upper limit 40	Limit = Numeric - 2 Lower limit 0
SpMet (%)		Entire range	Limit = Numeric + 2 Upper limit 15	Limit = Numeric - 2 Lower limit 0
		SpHb (g/dL)	Entire range	Limit = Numeric + 2
	SpHb (mmol/L)		Entire range	Limit = Numeric + 1
SpOC (ml/dL)			Entire range	Limit = Numeric + 2
		PVI (%)	Entire range	Limit = Numeric + 5

PI (%)	Entire range	Limit = Numeric + 2	Limit = 0
EtCO₂ (mmHg)	Entire range	Limit = Numeric + 10	Limit = Numeric - 5 mmHg <i>unless</i> the numeric falls below the lower alarm limit range, in which case Stat Set sets the lower limit to 15 mmHg.
FiCO₂ (mmHg)	Entire range	Limit = Numeric + 5	N/A
Temp (°C)	Entire range	Limit = Numeric + 0.5	Limit = Numeric - 0.5
Temp (°F)	Entire range	Limit = Numeric + 0.9	Limit = Numeric - 0.9

Chapter 6

Monitoring ECG

This chapter describes how to use the Propaq MD unit to monitor ECG.

Propaq MD units can perform ECG monitoring through 3-, 5-, or 12-lead ECG patient cables, Multi-Function Pads, or standard defibrillation paddles. The use of an ECG patient cable and electrodes is required, however, to monitor ECG during pacing.

OneStep cables and electrodes cannot be used for ECG monitoring.

You can use a 3-lead, 5-lead, or 12-Lead wire configuration for ECG monitoring (see Chapter 14, “12-Lead ECG Interpretive Analysis” for more information on 12-lead monitoring).

- Warning!**
- Excessive body hair or wet, sweaty skin may interfere with electrode adhesion. Remove the hair and/or moisture from the area where the electrode is to be attached.
 - Use only electrodes that are well within the expiration date indicated on the package.
 - Remove ECG electrodes from their sealed package immediately prior to use. Using previously opened or out-of- date electrodes may degrade the ECG signal quality.
 - Monitoring electrodes may become polarized during defibrillator discharge, causing the ECG waveform to briefly go off screen. ZOLL Medical Corporation recommends the use of high quality silver/silver chloride (Ag/AgCl) electrodes to minimize this effect; the circuitry in the instrument returns the trace to the monitor display within a few seconds.
 - To assure protection against the effects of defibrillator discharge, use only ZOLL-approved accessories.
 - To avoid a shock hazard and interference from nearby electrical equipment, keep electrodes and patient cables away from grounded metal and other electrical equipment.
 - To avoid electrosurgery burns at monitoring sites, ensure proper connection of the electrosurgery return circuit so that the return paths cannot be made through monitoring electrodes or probes.
 - Check the operation and integrity of the Propaq MD unit and ECG cable regularly by performing the Daily Operational Verification Test.
 - Implanted pacemakers may cause the heart rate meter to count the pacemaker rate during incidents of cardiac arrest or other arrhythmias. Carefully observe pacemaker patients. Check the patient's pulse; do not rely solely on heart rate meters. Dedicated pacemaker detection circuitry may not detect all implanted pacemaker spikes. Patient history and physical exam are important in determining the presence of an implanted pacemaker.
-

ECG Monitoring Setup

The proper application and placement of electrodes is essential for high quality ECG monitoring. Good contact between the electrode and skin minimizes motion artifact and signal interference.

The following procedure describes how to monitor a patient's ECG using 3- and 5-Lead ECG cables. For information on the application and use on MultiFunction Pads and External Paddles, which you can also use to monitor ECG, see , “Manual Defibrillation.”

To monitor a patient's ECG using 3- and 5-Lead ECG cables, perform the following steps:

1. Prepare the patient's skin for electrode application:
2. Apply the electrode pads to the patient.
3. Connect each lead of the ECG cable to the appropriate electrode.
4. Insert the patient cable plug into the ECG input connector on the Propaq MD unit.
5. Select the ECG waveforms to be displayed on the waveform trace display screen.
6. Observe the patient's electrocardiogram on the display, and adjust size of the ECG waveform trace, as necessary.

Preparing the Patient for Electrode Application

The proper application of electrodes is essential for high quality ECG monitoring. Good contact between the electrode and skin minimizes motion artifact and signal interference.

Before applying electrodes, prepare the patient's skin, as necessary:

- Shave or clip excess hair at electrode site.
- Clean oily skin with an alcohol pad.
- Rub site briskly to dry.

Applying Electrodes to the Patient

The following sections show where to place electrodes when using 3- and 5-Lead cables to perform ECG monitoring. For 3-Lead ECG cables, apply electrodes as in Figure 4-1, *3-Lead Electrode Placement*. For 5-Lead ECG cables, apply electrodes as in Figure 4-2, *5-Lead Electrode Placement*.

Avoid placing electrodes over tendons and major muscle masses.

Make sure that the ECG electrodes are placed to allow defibrillation, if necessary.

3-Lead Electrode Placement

Depending upon local usage, the ECG leads are marked either RA, LA, and LL (or R, L, and F). The following table shows the markings and color codes for the different lead sets.

AHA Color Coding	IEC Color Coding	Placement of Electrodes
RA/White Electrode	R/Red Electrode	Place near patient's right mid-clavicular line, directly below clavicle.
LA/Black Electrode	L/Yellow Electrode	Place near patient's left mid-clavicular line, directly below clavicle.
LL/Red Electrode	F/Green Electrode	Place between 6th and 7th intercostal space on patient's left mid-clavicular line.

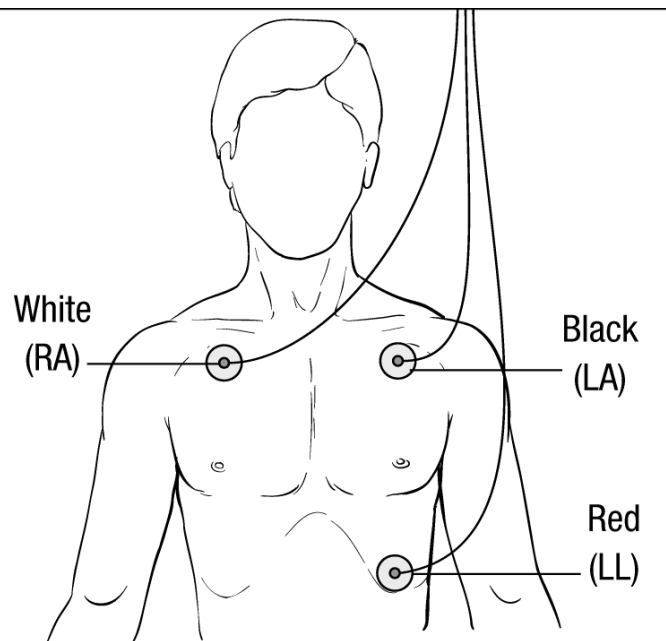


Figure 6-1 3-Lead Electrode Placement

5-Lead Electrode Placement

Depending upon local usage, the ECG leads are marked either RA, LA, LL, RL, and V or R, L, F, N and C. The following table shows the markings and color codes for the different lead sets.

AHA Color Coding	IEC Color Coding	Placement of Electrodes
RA/White Electrode	R/Red Electrode	Place near patient's right mid-clavicular line, directly below clavicle.
LA/Black Electrode	L/Yellow Electrode	Place near patient's left mid-clavicular line, directly below clavicle.
LL/Red Electrode	F/Green Electrode	Place between 6th and 7th intercostal space on patient's left mid-clavicular line.
RL/Green* Electrode	N/Black* Electrode	Place between 6th and 7th intercostal space on patient's right mid-clavicular line.
V/Brown* Electrode	C/White* Electrode	<p>Single movable chest electrode. Place this electrode in one of the positions, V1 - V6, as shown in the following figure.</p> <p>V1 -- 4th intercostal space at right sternal margin.</p> <p>V2 -- 4th intercostal space at left sternal margin.</p> <p>V3 -- Midway between V2 and V4 leads.</p> <p>V4 -- 5th intercostal space at mid-clavicular line.</p> <p>V5 -- Same transverse level as V4 at left anterior-axillary line.</p> <p>V6 -- Same transverse level as V4 at left mid-axillary line.</p>

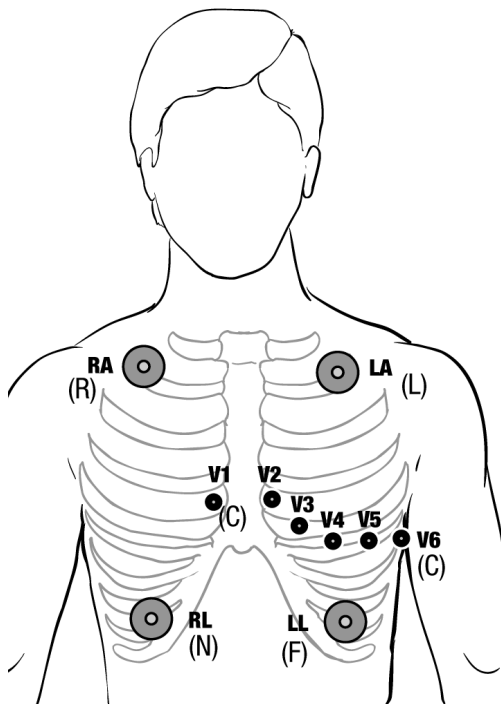


Figure 6-2 5-Lead Electrode Placement

Connecting the ECG Cable To the Propaq MD Unit

The Propaq MD unit accepts Welch Allyn Propaq[®] ECG cables as well as ZOLL Propaq MD ECG cables. Connect the ECG cable to the ECG connector on the left side of the Propaq MD unit as follows:

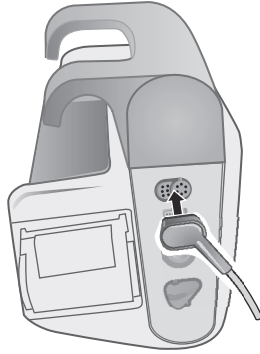
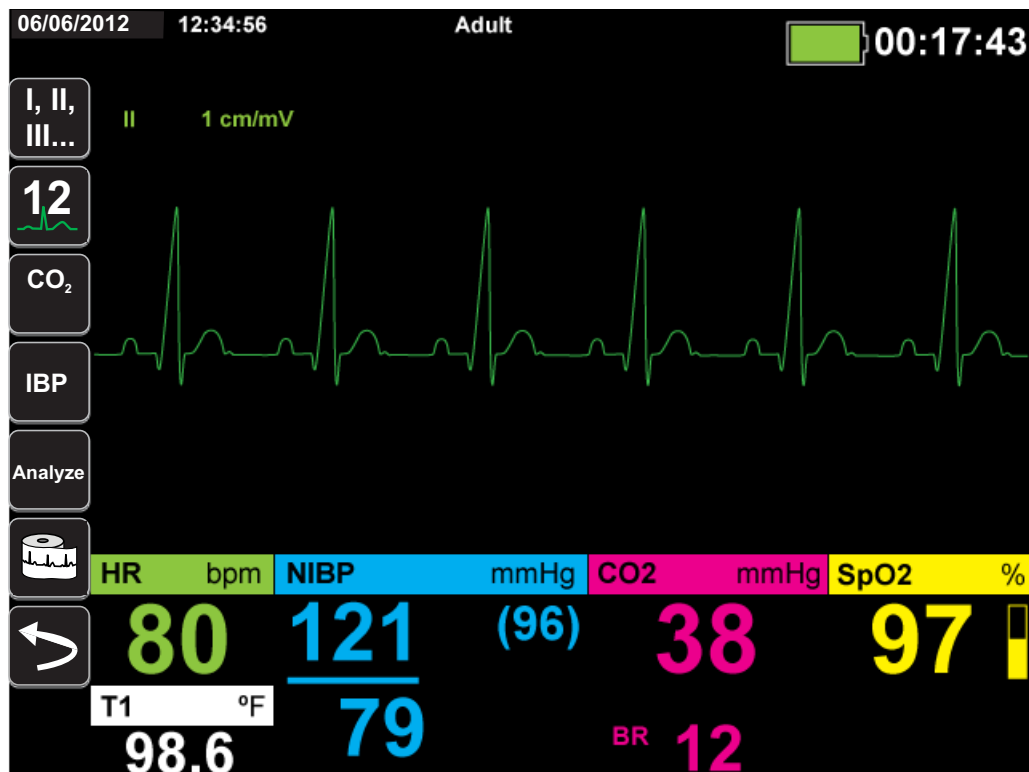



Figure 6-3 Connecting ECG Cable to Propaq MD Unit

Selecting ECG Waveforms for Display

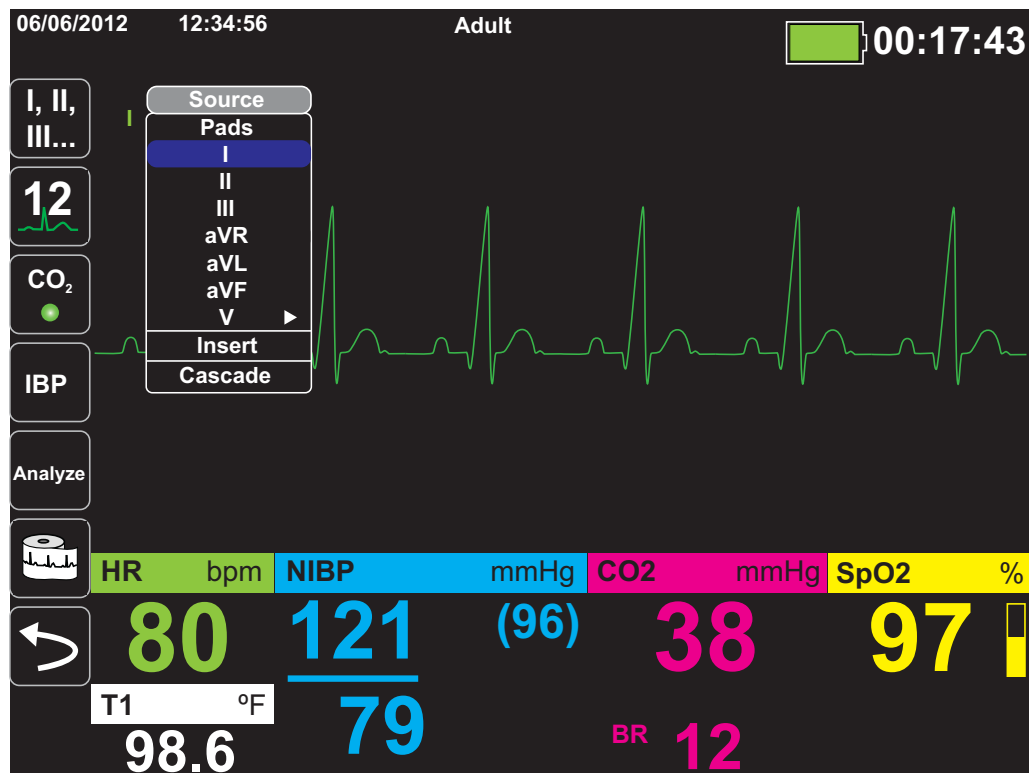
You can fit up to four waveforms on the Propaq MD display. The first waveform at the top of the display is always an ECG waveform. (If **Pads** are not connected, the unit can be configured to automatically default to another ECG lead.) In the following example, Lead II (RA-LL), is the source of the ECG waveform trace:



The Propaq MD unit is configured to display **Pads** by default for the top trace. If configured, the unit can also display four ECG traces on startup, when no other monitoring devices are attached.

There are two ways to specify which ECG lead is the source of the primary waveform trace. One way is to press the ECG lead selection quick access key  to display the available ECG waveform sources. The available waveform sources are determined by the type of ECG cable connected to the unit.

The other way to specify the source of the primary waveform trace is to navigate to and select the source label for the primary ECG waveform (Lead I in the screen below). The Propaq MD unit then displays the available ECG waveform sources. The following example illustrates the waveform source list that the Propaq MD unit displays when a 5-lead ECG cable is connected to it. The list of available ECG waveform sources includes Leads I, II, III, aVR, aVL, aVF, and V. You can select Lead II (the default), or use the navigation keys to highlight and select another displayed ECG lead as the source for the waveform trace.



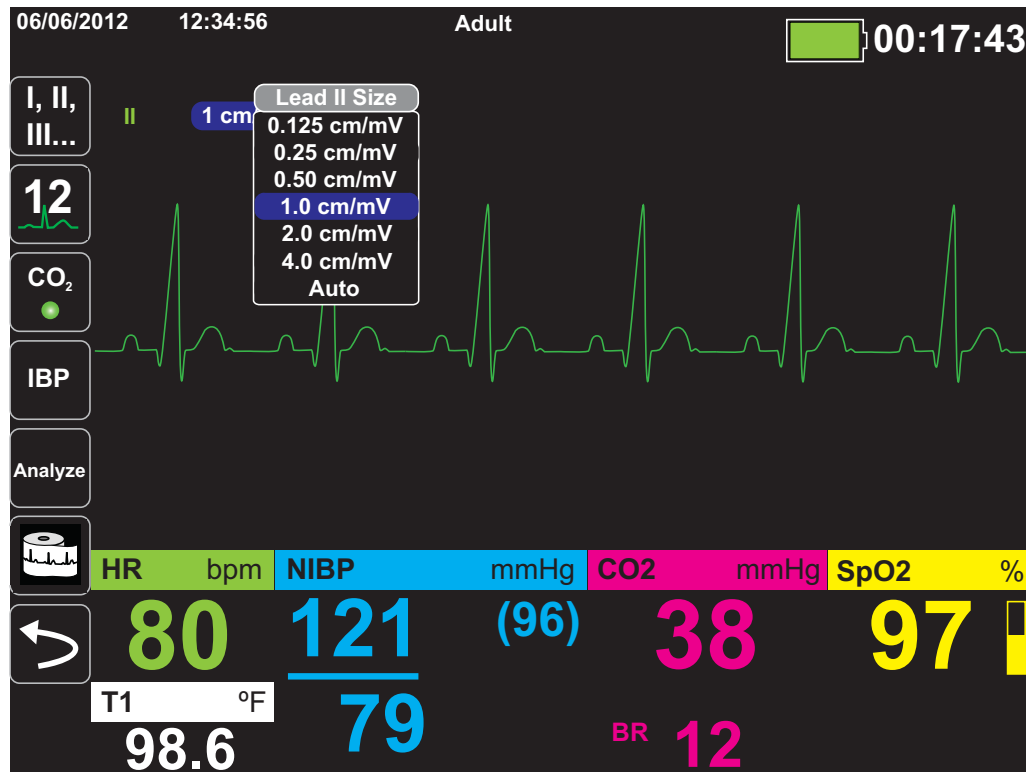
Select a current waveform source, and the unit displays the waveform immediately. If you select a waveform source that is not currently available, the unit displays the message, *LEAD FAULT*.

For more information on how to configure the display of waveforms on the Propaq MD unit, see Chapter 3, *Monitoring Overview*.

Selecting the Waveform Trace Size

The Propaq MD unit allows you to select the waveform trace size to adjust the size of displayed the ECG waveform.

To select the waveform size, use the navigation keys to highlight and select the trace size that appears to the right of the electrode label:



The default trace size is **1cm/mV**. You can select a larger (**2.0, 4.0 cm/mV**) or smaller (**0.125, 0.25, 0.50 cm/mV**) trace size. You can also specify that the Propaq MD unit select a best-fit trace size (**AUTO**).

ECG Monitoring and Pacemakers

When the unit performs ECG monitoring on a patient with an implantable pacemaker, the unit's Pacer indicator feature can indicate the occurrence of pacemaker signals.

If the Pacer Indicator setting is **ON**, the Propaq MD performs the following actions:






- detects the implantable pacemaker pulses
- blanks the pacemaker pulses from the waveform—preventing them from disturbing the ECG waveform and allowing for an accurate QRS detection
- displays and prints vertical dashed lines to indicate the detected pacemaker signals

If the Pacer Indicator setting is **OFF**, the Propaq MD does not perform the following actions:

- detect the implantable pacemaker pulses
- blank the pacemaker pulses from the waveform
- display or print the vertical dashed line pacer markers

You can turn the Pacer Indicator **ON/OFF** from the Setup>ECG menu.

To turn the Pacer Indicator **ON/OFF**:

1. Press the **More** quick access key ()
2. Press the **Setup** quick access key ()
3. Use the navigation keys to select **ECG** then press .
4. Use the navigation keys to highlight and select **Patient Pace Marker** then press .
5. Use the navigation keys to select **On** or **Off** as appropriate. When you select **Off**, the Pacer Off Indicator () icon appears in the top ECG trace on the Display Screen to indicate the pacer indicator is off. If the patient has a cardiac pacemaker, the Pacer Indicator should be set to **On** indicating that pace pulse detection is On.

There are situations where ECG artifact could simulate pacemaker signals which could cause false pacemaker detection and blanking. These situations may cause inaccurate QRS detection and it may be desirable to turn the Pacer Indicator off. Inversely, when the Pacer Indicator setting is **OFF**, implantable pacemaker signals may cause inaccurate QRS detection and it may be desirable to turn the Pacer Indicator on.

ECG System Messages

When monitoring ECG, the Propaq MD unit may display the following messages:

System Message	Cause
<i>LEAD FAULT</i>	<p>The current ECG source lead is defective (check lead and replace, if necessary).</p> <p style="text-align: center;">-- OR --</p> <p>An unavailable waveform source has been specified for the trace display (check specified waveform source and correct, if necessary).</p>
<i>PADDLE FAULT</i> or <i>CABLE FAULT</i>	<p>Check the pad, paddle or cable and replace if necessary.</p> <p>Remove the Multi-Function Cable and electrodes from the AutoPulse Plus, and connect the Multi-Function Cable directly to the electrodes.</p>

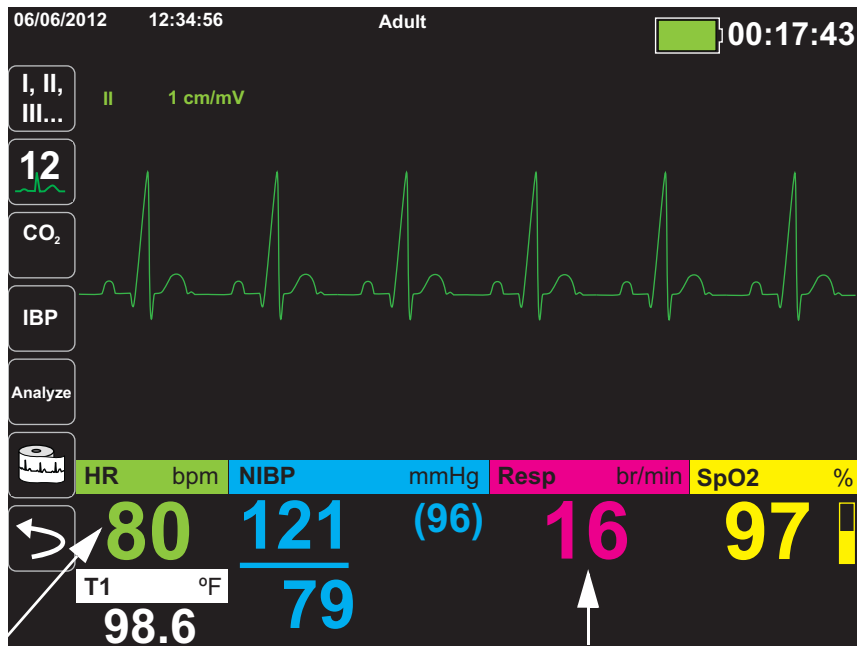
Note: If an ECG Monitoring cable is intentionally disconnected, you can disable the Lead Fault alarm by Pausing (Suspending) the alarm audio. See “Pausing (Suspending) Alarms” on page 5-6 for more information.

Chapter 7

Monitoring Respiration (Resp) and Heart Rate (HR)

This chapter describes how to use the Propaq MD unit to monitor Respiration (**Resp**) and Heart Rate (**HR**).

The Propaq MD unit displays Respiration (**Resp**) and Heart Rate (**HR**) meters. The Respiration and Heart Rate meters display values that the Propaq MD unit derives from measurements taken by other Propaq MD monitoring functions.



Heart Rate Meter

Respiration Meter

Note: The respiration rate is disabled during defibrillation. During defibrillation, the respiration rate will display ??? on the snapshot.

Respiration/Breath Rate Meter

If enabled, the Propaq MD unit displays the patient's respiration in the Respiration/Breath Rate Meter.



The respiration meter displays the respiration rate that it derives, by default, from the unit's CO₂ monitoring function. If CO₂ monitoring is not available, the unit derives the respiration rate through *impedance pneumography*, using a specified ECG electrode configuration. If ECG monitoring isn't functioning, the **Resp/BR** meter will not display a respiration rate.

Using Impedance Pneumography to Measure Respiration

Impedance pneumography detects respiration by applying a high-frequency, low-current AC signal to the patient and measuring the changes in impedance through ECG electrode Lead I (RA-LA) or Lead II (RA-LL). As the patient inhales and chest volume expands, impedance increases; as the patient exhales, impedance decreases.

Warning!


- Impedance pneumography detects respiratory effort through changes in chest volume. However, No Breath episodes with continued respiratory effort may go undetected. Always monitor and set alarms for SpO₂ when using impedance pneumography to monitor respiratory function.
 - With any monitor that detects respiratory effort through impedance pneumography, artifact due to patient motion, apnea mattress shaking, or electrocautery use may cause apnea episodes to go undetected. Always monitor and set alarms for SpO₂ when using impedance pneumography to monitor respiratory function.
 - When using impedance pneumography, don't use the Propaq MD unit with another respiration monitor on the same patient, because the respiration measurement signals may interfere with one another.
 - Impedance pneumography is *not* recommended for use on paced patients, because pacemaker pulses may be falsely counted as breaths.
 - Impedance pneumography is not recommended for use with high frequency ventilation.
 - Since impedance pneumography uses the same leads as the ECG channel, the Propaq MD unit determines which signals are cardiovascular artifact and which signals are the result of respiratory effort. If the breath rate is within five percent of the heart rate, the monitor may ignore breaths and trigger a respiration alarm.
-

Configuring Respiration (RR/BR) Alarms and Settings





The Propaq MD unit allows you to enable and disable the Respiration (**RR/BR**) Rate alarm, to set alarm limits, and to specify the ECG monitoring source for the Respiration rate.

Enabling/Disabling RR/BR Alarms and Setting Alarm Limits

When enabled, the Propaq MD unit sounds alarms whenever the patient's respiration rate is above or below the specified respiration rate alarm limits.

To enable (or disable) Resp alarms and set Upper and Lower alarm limits, you can either do so through the Alarms quick access key () or the **Resp Parameter Control Panel**.

To configure **RR/BR** alarms through the **Alarms** quick access key:

1. Press .
2. Press .
3. Press the **Limits** quick access key () . Use the navigation keys to highlight and select the **RR/BR Alarm** menu selection.
4. On the **RR/BR Alarm Settings** menu, use the navigation keys to select the fields that you want to change:
 - **Upper Limit Enable**
 - **Lower Limit Enable**
 - **Upper Limit**
 - **Lower Limit**
5. When you are finished changing values on the alarm menu, navigate to the Backarrow key () to confirm your choices and exit the menu.

Respiration Rate Alarm Limits

Initially, the **Resp Alarm Settings** menu specifies that Resp alarms are enabled (**ON**) or disabled (**OFF**), and displays the default Upper and Lower respiration rate alarm limits. The upper and lower limits can be **ON** or **OFF** (default is **OFF**). The following table lists the default respiration rate alarm limits for adult, pediatric, and neonate patients, and gives the range in which you can set these limits:

Patient Type	Respiration Rate Default	Respiration Rate Range
Adult	Lower: 3 br/min Upper: 50 br/min	Lower: 0 to 145 br/min Upper: 5 to 150 br/min
Pediatric	Lower: 38 br/min Upper: 50 br/min	Lower: 0 to 145 br/min Upper: 5 to 150 br/min
Neonate	Lower: 12 br/min Upper: 80 br/min	Lower: 0 to 145 br/min Upper: 5 to 150 br/min

Using the Resp Parameter Control Panel

To configure alarms through the **Resp** Parameter Control Panel, use the navigation keys to highlight and select the Respiration Rate meter and display the **Resp** Parameter Control Panel:

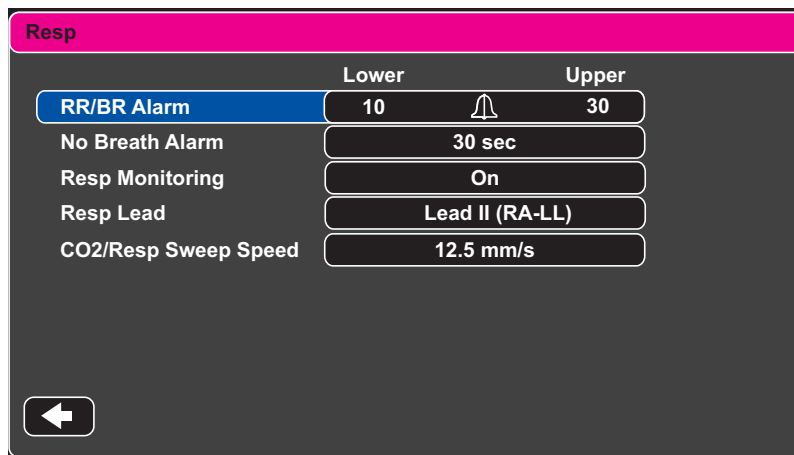


Figure 7-1 Respiration Parameter Control Panel

The **Resp** Parameter Control Panel allows you to set the following parameters:

- **RR/BR Alarm** -- enable/disable the Resp alarm and set high/low alarm limits.
- **No Breath Alarm** -- sets the duration of the No Breath alarm, or disables alarm by selecting "Off".
- **Resp Monitoring** -- enable/disable respiration monitoring.
- **Resp Lead** -- selects the Resp lead, Lead I (RA-LA) or Lead II (RA-LL), from which the Propaq MD unit calculates the respiration rate. Resp Lead selection is independent of ECG Lead selection.
- **CO2/Resp Sweep Speed** -- sets the respiratory sweep speed on the display.

Enabling/Disabling Resp Monitoring

Select the Resp Monitoring prompt to enable or disable **Resp** monitoring. When Resp Monitoring is set to On (the default), the Propaq MD unit displays the Respiration Rate Meter. When set to off, Propaq MD removes the Respiration Rate meter from the display.

Warning! When using impedance pneumography, the Propaq MD unit automatically rejects cardiovascular artifact (CVA). This function requires the accurate ECG R-wave detection. Therefore, always select the ECG lead with the most prominent QRS complex when using impedance pneumography to monitor respiration.

Heart Rate Meter

The Heart Rate meter displays the heart rate that it derives from the ECG monitoring function (by default) or from a monitoring function that you specify. If the ECG (or user-specified monitor function) measurements are not available, the Heart Rate meter derives the heart rate from the following monitoring functions, if they are available, in this order: User-selected default source, ECG, IBP channel 1, SpO₂, IBP channel 2, IBP channel 3, and NIBP. The Heart Rate meter is labeled **HR** (as in the following example) if the source is ECG, and **PR** if any other source is used.

Note: The Heart Rate meter displays heart rates below 20 as three dashes (---) and heart rates above 300 as three plus signs (+++).




Configuring Heart Rate (HR) Meter Alarms




The Propaq MD unit allows you to enable and disable the Heart Rate (HR) alarm, to set alarm limits, and to select a Heart Rate tone.


Enabling/Disabling HR Alarms and Setting Alarm Limits

When enabled, the Propaq MD unit sounds alarms whenever the patient's heart rate is above or below the specified heart rate alarm limits.

To enable (or disable) HR alarms and set Upper and Lower alarm limits, you can either do so through the Alarms quick access key () or the **HR/PR Parameter Control Panel**.

To configure HR alarms through the **Alarms** quick access key:

1. Press .
2. Press .
3. Press .
4. Use the navigation buttons to highlight and select **HR/PR Alarm**.
5. On the HR/PR Alarm Settings menu, use the navigation keys to select the fields that you want to change:
 - **Upper Limit Enable**
 - **Lower Limit Enable**
 - **Upper Limit**
 - **Lower Limit**

 When you are finished changing values on the alarm menu, navigate to the Backarrow key to confirm your choices and exit the menu.

Heart Rate (HR/PR) Alarm Limits

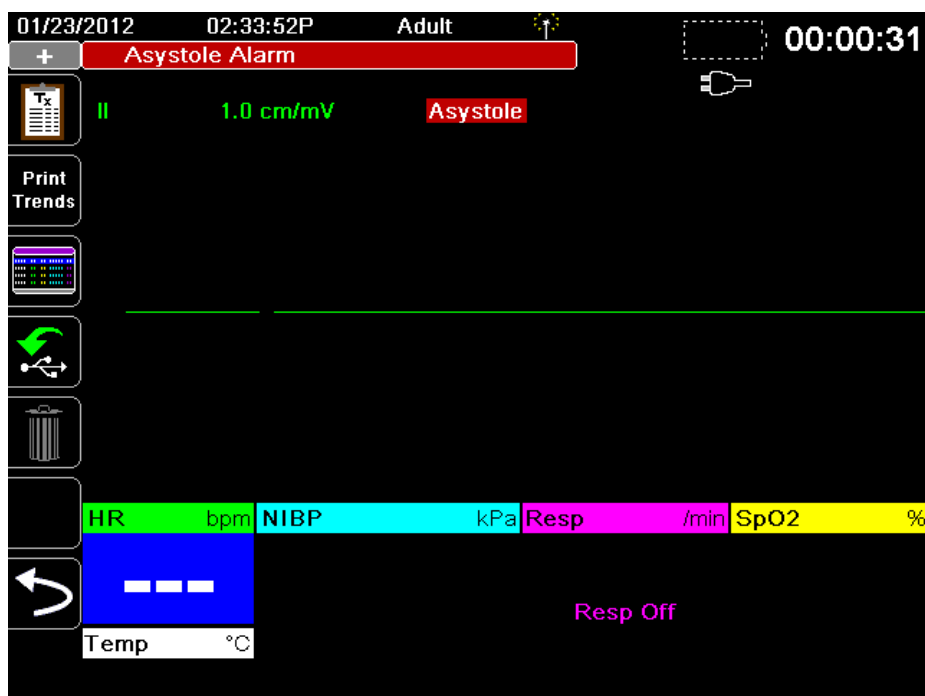
Initially, the HR/PR Alarm Settings menu specifies that alarms are enabled (**ON**) or disabled (**OFF**), and displays the default Upper and Lower heart rate alarm limits. The upper and lower limits can be **ON** or **OFF** (default is **OFF**). The following table lists the default HR alarm limits for adult, pediatric, and neonate patients, and gives the range in which you can set these limits:

Patient Type	HR Default	HR Rate Range
Adult	Lower: 50 BPM Upper: 120 BPM	Lower: 30 to 298 BPM Upper: 32 to 300 BPM
Pediatric	Lower: 50 BPM Upper: 150 BPM	Lower: 30 to 298 BPM Upper: 32 to 300 BPM
Neonate	Lower: 100 BPM Upper: 200 BPM	Lower: 30 to 298 BPM Upper: 32 to 300 BPM

Life Threatening Rhythm Alarms




When LTA monitoring is enabled, the Propaq MD unit will monitor for the following life threatening ECG rhythms: asystole, ventricular fibrillation, ventricular tachycardia, extreme bradycardia, and extreme tachycardia. These events are also displayed on Treatment Summary Reports, Alarm Snapshots, and Continuous Waveform printouts.


The following example shows an Asystole alarm event:



To enable or disable LTA alarms and set Extreme Brady/Tachy alarm limits, you can either do so through the Alarms quick access key (🔔), or the **HR/PR Parameter Control Panel**.

To configure LTA alarms through the Alarms quick access key:

1. Press .
2. Press .
3. Press . Use the navigation keys to highlight and select the fields that you want to change:
 - **LTA Monitoring**
 - **Extreme Brady/Tachy Alarms**

 When you are finished changing values on the alarm menu, navigate to the Backarrow key to confirm your choices and exit the menu.

Extreme Bradycardia and Extreme Tachycardia Alarm Limits

The Extreme Brady/Tachy Alarm Settings menu specifies the configured delta values that are applied to the HR lower limit alarm and HR upper limit alarm for the Extreme Bradycardia and Extreme Tachycardia LTA alarm detection, respectively. For example, if the HR lower limit alarm is configured to 50 and the Extreme Brady delta value is configured to -10, the Extreme Bradycardia LTA detection threshold will be at 40 bpm. Likewise, if the HR upper limit alarm is configured to 120 and the Extreme Tachy delta value is configured to +20, the Extreme Tachycardia LTA detection threshold will be at 140 bpm. The HR lower and upper limit alarms are not required to be enabled for the Extreme Bradycardia and Extreme Tachycardia LTA alarm detection to be enabled. The Extreme Bradycardia and Extreme Tachycardia LTA alarms will not activate until 20 seconds after the alarm limit threshold is crossed.

The following tables list the default Extreme Bradycardia and Extreme Tachycardia alarm limits for adult, pediatric, and neonate patients, and the ranges in which you can set these limits:

Extreme Bradycardia Alarm Limits


Patient Type	Default	Delta Value Range
Adult	-10	-5 to -30 in increments of 5
Pediatric	-10	-5 to -30 in increments of 5
Neonate	-10	-5 to -30 in increments of 5

Extreme Tachycardia Alarm Limits

Patient Type	Default	Delta Value Range
Adult	+20	+5 to +30 in increments of 5
Pediatric	+20	+5 to +30 in increments of 5
Neonate	+20	+5 to +30 in increments of 5

Acknowledging LTA Alarms

LTA alarms are latching, which means that the alarm indication will persist until both of the following conditions are met:

1. The alarm has been acknowledged by pressing the **Alarm Pause (Silence)/Reset** button  on the front panel of the unit.
2. The alarming condition no longer exists.

Using the Heart Rate Parameter Control Panel

To configure alarms through the Heart Rate Parameter Control Panel, use the navigation keys to highlight and select the Heart Rate meter and display the HR/PR Parameter Control Panel:

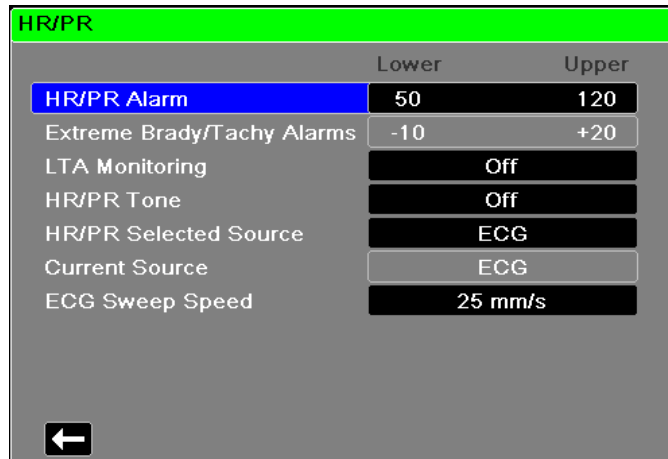


Figure 7-2 HR/PR Parameter Control Panel

Selecting the **HR/PR Alarm** prompt displays the **HR/PR Alarm Settings** menu, on which you can enable/disable Heart Rate alarms and set alarm limits.

RESP System Message

When monitoring Respiration using impedance pneumography, the Propaq MD unit may display the following message:

System Message	Cause
<i>RESPIRATION FAULT</i>	The impedance measured through the ECG lead is too high for the unit to detect Respiration changes, but not high enough to indicate an ECG lead fault (the impedance may vary between 1800 and 2800 ohms).

Chapter 8

Monitoring Non-Invasive Blood Pressure (NIBP)

The Propaq MD NIBP input is Type CF defibrillator proof.

This chapter describes how to use the Propaq MD unit's NIBP option to perform Non-Invasive Blood Pressure (NIBP) measurements using an inflatable cuff to measure arterial pressure.

The Propaq MD uses the enhanced NIBP features of Welch Allyn's SureBP and patented Smartcuf motion-tolerant technology.

The Propaq MD unit must perform ECG monitoring when using Smartcuf.

The SureBP monitoring software allows the Propaq MD unit to take an NIBP measurement as the cuff is inflating, which saves time -- the measurement takes about 15 seconds -- and improves patient comfort.

The Smartcuf monitoring software enables the Propaq MD unit to make accurate NIBP measurements in the presence of extreme artifact, weak pulses, and some dysrhythmias by synchronizing the NIBP measurements with the patient's R-wave.

- Warning!**
- **Observe the patient's limb periodically to ensure that circulation is not impaired for a prolonged period of time.**
 - **Do not place cuff over a wound, as this can cause further injury.**
 - **Do not allow the NIBP tubing to become kinked or crushed. This could prevent normal cuff deflation resulting in patient injury due to prolonged restriction of blood flow.**
 - **Never use the Propaq MD to monitor NIBP on one patient while simultaneously monitoring ECG on another patient.**
 - **If a non-invasive blood pressure measurement is suspect, repeat the measurement. If you are still uncertain about the measurement, use another method.**
 - **Do not use NIBP without proper training.**
 - **Check that the correct patient mode has been selected to ensure that the initial inflation pressure is set correctly. If an over-range indication (+++) occurs when monitoring NIBP on a large or older child, change the patient mode selection from pediatric to adult.**
 - **Patient movement, very low pulse volume, or vibration from outside sources can influence the accuracy of blood pressure measurements.**
 - **Do not attempt to take NIBP measurements on patients during cardiopulmonary bypass procedures.**
 - **Some or all NIBP safety functions are disabled when performing the NIBP test in the Service menu. Do not conduct NIBP tests when the cuff is attached to a patient.**
 - **The effectiveness of this sphygmomanometer has not been established in pregnant, including pre-eclamptic, patients.**
-

How does NIBP Work?

The blood pressure cuff and hose connect to the Propaq MD unit through the NIBP connector on the side panel of the unit. The **NIBP** button on the front panel of the unit allows you to initiate and terminate blood pressure measurements, which are displayed in the NIBP area of the monitor.

The Propaq MD unit's NIBP module measures the oscillometric pulses transmitted through the blood pressure cuff and hose, and calculates the blood pressure measurements accordingly. The pressure measurement proceeds as follows:

1. The cuff inflates to a preconfigured pressure (determined by patient type) above the patient's systolic blood pressure. As the cuff inflates, the Propaq MD unit measures the oscillometric pulses transmitted from the cuff through the hose, and the SureBP monitoring software calculates the patient's systolic, diastolic, and mean blood pressure. Once these measurements are taken, the cuff deflates. The Propaq MD unit takes these measurements in about 15 seconds.

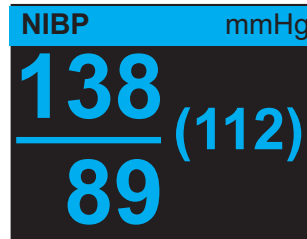
The SureBP feature requires the use of a cuff and dual lumen hose.

2. If high artifact prevents an accurate measurement during cuff inflation, or if you use a cuff and single lumen hose, the cuff inflates to its target pressure to occlude blood flow through the arteries in the monitored limb. The cuff deflates incrementally, allowing blood to flow through the cuff and into the monitored limb. As blood flows through the partially deflated cuff, it produces pressure oscillations that are transmitted to the Propaq MD unit through the hose. The Propaq MD unit measures the oscillometric pulses and uses them to calculate the corresponding systolic, diastolic, and mean blood pressure. This measurement takes about 30 seconds.
3. The NIBP option automatically adjusts the blood pressure measurement procedure in response to certain error conditions such as:

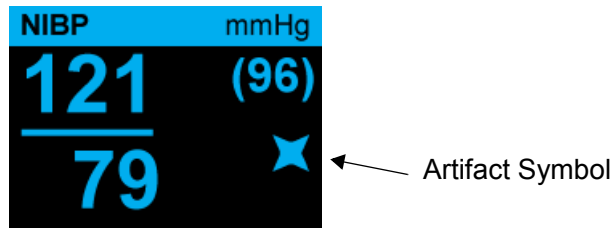
Condition	Adjustment/Response
The unit cannot detect systolic pressure	The unit automatically increases the cuff inflation pressure and completes the blood pressure measurement
The unit cannot detect systolic, diastolic or mean pressure after 180 seconds	The unit aborts the blood pressure measurement and deflates the cuff
The unit detects a fault	The unit displays a corresponding error message on the monitor and aborts the measurement

The NIBP Numeric Display

When NIBP monitoring has been set up and the Propaq MD unit has begun taking NIBP measurements, the systolic, diastolic, and mean blood pressure measurements appear on the NIBP numeric display as follows:



The Artifact symbol (✱) appears on the NIBP numeric display whenever the Propaq MD unit detects that NIBP measurements (systolic, diastolic, mean) may be inaccurate. The symbol displays when NIBP measurements are below the specified measurement range for the selected patient type or when the accuracy of NIBP measurements may be compromised by the presence of motion artifact, weak pulses, cardiac arrhythmias or other blood pressure artifacts.



Note: For a list of system messages that may display on the Propaq MD unit when monitoring NIBP see “NIBP System Messages” on page 8-16.

The following sections describe how to set up NIBP monitoring.

NIBP Setup and Use

To take safe and accurate NIBP measurements using the Propaq MD unit, you must perform the following steps, each of which corresponds to a section in this chapter. Read each section carefully before you perform NIBP measurements.

1. Select the correct size cuff.
2. Apply the cuff to the patient.
3. Connect the inflation hose to the Propaq MD unit and to the cuff.
4. Configure NIBP alarms and settings (if the current NIBP alarms and settings are not appropriate).
5. Press the **NIBP** button on the Propaq MD unit’s front panel and take the blood pressure measurement.

Selecting the NIBP Cuff

To take accurate measurements, you must use the proper sized cuff: the cuff's bladder length should be at least 80 percent of the limb circumference, while the cuff width should be equal to 40 percent of the limb circumference.

Caution Use only hoses and cuffs that are approved by ZOLL Medical Corporation. See Appendix B, *Accessories*, for a listing of the approved hoses and cuffs. Use the following guidelines when selecting the appropriate hose and cuff:

	Adult Mode	Pediatric Mode	Neonate Mode
Cuffs (typical cuff labeling)	Adult, Large Adult, Small Adult, Child, Thigh	Child, Small Child, Small Adult, Infant, Newborn	Neonate #1 to #5 -- disposable Newborn (#6), Infant (#7) -- reusable
Recommended Limb Circumference	15 cm or greater.	7.7 to 25 cm	15 cm or less
Hoses	Adult	Adult	Neonate/Infant (Disposable Cuff only) * Reusable Newborn (#6) and Infant (#7) cuffs use the Adult Hose.

Caution Selection of the correct cuff is critical to the accuracy of NIBP measurements. Using a cuff that is too small results in measurements higher than the patient's actual blood pressure. Using a cuff that is too large results in measurements lower than the patient's actual blood pressure.

The Propaq MD unit uses the same definitions of Neonates, Pediatrics, and Adults as defined in the AAMI SP10:2002 standard:

Neonate or Newborn Children 28 days or less of age if born at term (37 weeks gestation or more); otherwise, up to 44 gestational weeks

Pediatric or Child (other than newborn) Individuals between 29 days and 12 years of age

Adult Individuals greater than 12 years of age

Connecting the NIBP Cuff

Connecting the NIBP cuff requires you to attach the inflation hose to the Propaq MD unit and the NIBP cuff. To use the SureBP feature, which enables the Propaq MD unit to measure blood pressure on cuff inflation, you must use the FlexiPort cuff and dual lumen (two-tube) adaptor and hose. You can also use a single lumen (one-tube) hose and adaptor with the Propaq MD unit, but the unit will only measure blood pressure on cuff deflation.

To connect the NIBP cuff to the Propaq MD unit:

1. Attach the inflation hose's threaded metal connector to the NIBP connector on the side panel of the Propaq MD unit. Mesh the threads carefully so that the connector turns easily and then turn the connector in a clockwise direction until it is snug. Attach a double lumen hose as follows:



Figure 8-1 Attaching a Dual Lumen Hose to the Propaq MD Unit

Attach a single lumen hose as follows:

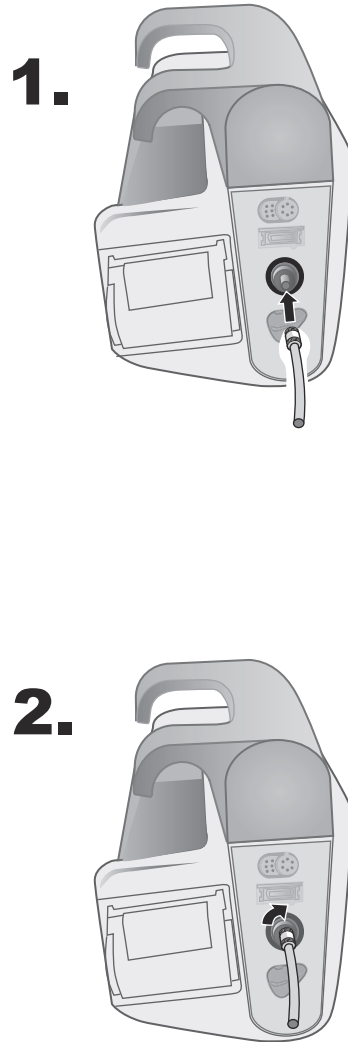
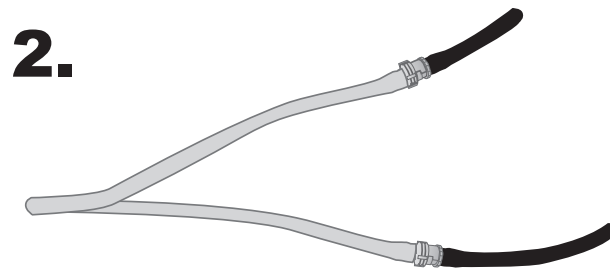
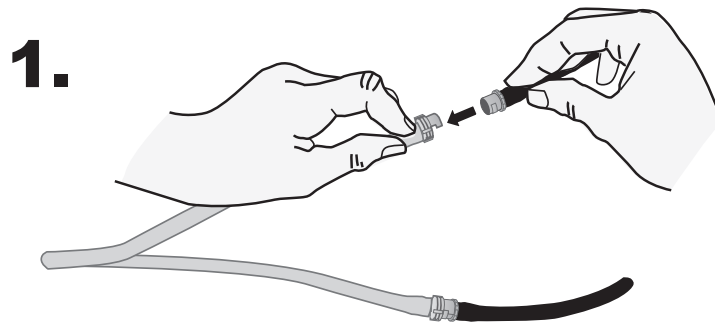


Figure 8-2 Attaching Single Lumen Hose to the Propaq MD Unit

2. Insert the plastic connectors on the NIBP hose into the cuff hose connector, and twist the connectors until they lock. The connectors are the same; you can insert either of the plastic connectors into either of the cuff hose connectors in any order.



Applying the Cuff to the Patient

To apply the cuff to the patient:

1. Ensure the patient is lying down or comfortably seated with legs uncrossed, both feet on the floor, and back supported. The limb to be used for NIBP measurement should be relaxed, extended, and placed on a smooth surface for support. The operator position is not restricted during NIBP measurement.
2. Squeeze as much air from the cuff as possible before placing it on the patient.
3. Place the cuff 2 to 5 cm above the elbow crease or 5 to 10 cm (1.9 to 3.9 in.) above the knee crease.

-
- Warning!**
- **Do not place the NIBP cuff on the same arm or leg as an SpO₂ sensor. Inflation of the cuff causes the SpO₂ monitor to read incorrectly.**
 - **Do not attach the cuff to a limb being used for IV infusion. Cuff inflation might block the infusion, causing harm to the patient.**
 - **Do not place cuff over a wound, as this can cause further injury.**

-
4. Adjust the cuff so that the artery marker on the cuff is over the artery, pointing to the hand or foot.
 5. Check that the cuff ends between the range lines marked on the cuff.
 6. If they do not line up, use a different size cuff.
 7. Wrap the deflated cuff snugly around the limb without impeding blood flow.
 8. Ensure that the hose is routed to avoid kinking or compression.

-
- Caution**
- Using a cuff that is loosely applied or too small results in measurements higher than the patient's actual blood pressure.
 - Using a cuff that is too large results in values lower than the patient's actual blood pressure.
 - Ideally, the cuff should be at the same level as the heart. Cuff placement substantially above or below heart level will result in blood pressure measurements that are erroneously low or high.
-

The following illustrates one possible cuff placement for adult/pediatric patients and, to the right, possible cuff placements for neonates:

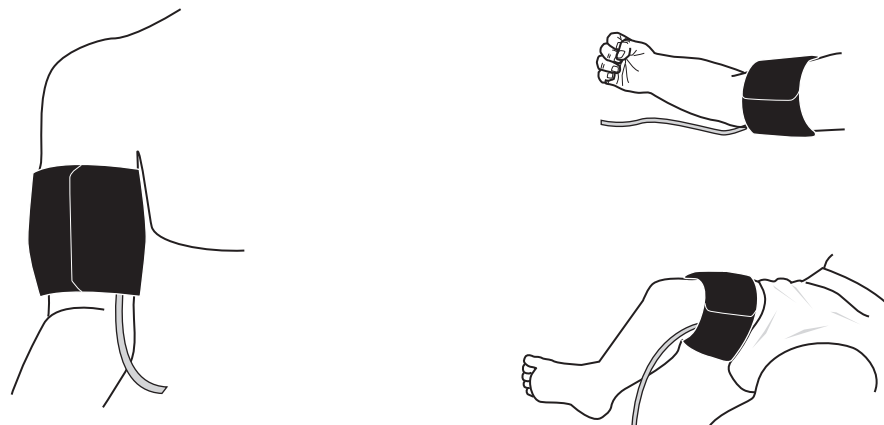


Figure 8-3 Applying Cuff to the Patient

Ensuring Correct Cuff Inflation Settings

Before taking an NIBP measurement for a new patient, ensure that the cuff inflation settings are appropriate for that patient.

Check that the correct patient mode is selected. The initial Cuff Inflation Target (CIT) pressure is dependent on the patient type and the configured CIT preset. The default and configurable CIT presets for each patient type are indicated in the following table (default values are in bold).

Note: You can configure the CIT pressure from the Setup>NIBP menu.

Adult	Pediatric	Neonate
120 mmHg	80 mmHg	60 mmHg
140 mmHg	90 mmHg	70 mmHg
160 mmHg	100 mmHg	80 mmHg
180 mmHg	110 mmHg	90 mmHg
200 mmHg	120 mmHg	100 mmHg
220 mmHg	130 mmHg	110 mmHg
240 mmHg	140 mmHg	120 mmHg
260 mmHg	150 mmHg	130 mmHg

In order to accurately measure systolic pressure, the CIT pressure must be high enough to occlude the underlying artery. However, setting the CIT pressure too high may unnecessarily increase the reading determination time and patient discomfort.

After each NIBP measurement, the Propaq MD unit adjusts the cuff inflation pressure to optimize the next NIBP measurement.

Note: The maximum cuff inflation pressure for neonates is 153 mmHg.

Warning! Before using the Propaq MD unit to monitor a new patient, power down the unit for *at least 2 minutes* to reset all patient parameters and eliminate all adjustments made for the previous patient.


Configuring NIBP Alarms and Settings

The last step in preparing to perform NIBP measurements is to ensure that the necessary alarms are enabled (or disabled), that alarm limits are appropriate, and that the NIBP settings are correct.





Enabling/Disabling NIBP Alarms and Setting Alarm Limits

When enabled, the Propaq MD unit sounds alarms whenever measurements are outside set limits for the following:

- High and Low Systolic Pressure
- High and Low Diastolic Pressure
- High and Low Mean Arterial Pressure (MAP)

To enable (or disable) NIBP alarms and set upper and lower alarm limits, you can do so through the Alarms quick access key () or the **NIBP Parameter Control Panel**.

To configure NIBP alarm limits through the Alarms quick access key:

1. Press the **More** quick access key ()
2. Press the **Alarms** quick access key ()
3. Press the **Limits** quick access key ()
4. Use the navigation keys to highlight and select the appropriate alarm menu selection. For NIBP, the alarm menu selections are **NIBP Systolic Alarm**, **NIBP Diastolic Alarm**, and **NIBP MAP Alarm**.
5. On the selected NIBP alarm settings menu, use the navigation keys to select the fields that you want to change. The fields are
 - **Upper Limit Enable**
 - **Lower Limit Enable**
 - **Upper Limit**
 - **Lower Limit**
6. When you are finished changing values on the alarm settings menu, select the back arrow to exit the menu. ()

Setting Upper and Lower Systolic Alarm Limits

Initially, the **NIBP Systolic Alarm Settings** menu specifies that the NIBP systolic pressure alarms are enabled (**ON**) or disabled (**OFF**), and displays the default upper and lower systolic limits. The upper and lower limits can be **ON** or **OFF** (default is **OFF**). The following table lists the default NIBP Systolic limits for adult, pediatric, and neonate patients, and gives the range in which you can set these limits:

Patient Type	NIBP Systolic Limit Default	NIBP Systolic Limit Range
Adult	Lower: 75 mmHg Upper: 220 mmHg	Lower: 30-258 mmHg Upper: 32-260 mmHg
Pediatric	Lower: 75 mmHg Upper: 145 mmHg	Lower: 30-158 mmHg Upper: 32-160 mmHg
Neonate	Lower: 50 mmHg Upper: 100 mmHg	Lower: 20-118 mmHg Upper: 22-120 mmHg

Setting Upper and Lower Diastolic Alarm Limits

Initially, the **NIBP Diastolic Alarm Settings** menu specifies that the NIBP diastolic pressure alarms are enabled (**ON**) or disabled (**OFF**), and displays the default Upper and Lower diastolic limits. The upper and lower limits can be **ON** or **OFF** (default is **OFF**). The following table lists the default diastolic limits for adult, pediatric, and neonate patients, and gives the range in which you can set these limits:

Patient Type	Diastolic Limit Default	Diastolic Limit Range
Adult	Lower: 35 mmHg Upper: 110 mmHg	Lower: 20-218 mmHg Upper: 22-220 mmHg
Pediatric	Lower: 35 mmHg Upper: 100 mmHg	Lower: 20-128 mmHg Upper: 22-130 mmHg
Neonate	Lower: 30 mmHg Upper: 70 mmHg	Lower: 10-108 mmHg Upper: 12-110 mmHg

Setting Upper and Lower NIBP MAP Alarm Limits

Initially, the **NIBP MAP Alarm Settings** menu specifies that **NIBP MAP** alarms are enabled (**ON**) or disabled (**OFF**), and displays the default Upper and Lower MAP limits. The upper and lower limits can be **ON** or **OFF** (default is **OFF**). The following table lists the default MAP alarm limits for adult, pediatric, and neonate patients, and gives the range in which you can set these limits:

Patient Type	MAP Default	MAP Range
Adult	Lower: 50 mmHg Upper: 120 mmHG	Lower: 25-230 mmHg Upper: 23-228 mmHg
Pediatric	Lower: 50 mmHg Upper: 110 mmHg	Lower: 25-140 mmHg Upper: 23-138 mmHg
Neonate	Lower: 35 mmHg Upper: 80 mmHg	Lower: 15-110 mmHg Upper: 13-108 mmHg

Using the NIBP Parameter Control Panel

Use the navigation keys to highlight and select the NIBP numeric display to display the **NIBP Parameter Control Panel**:

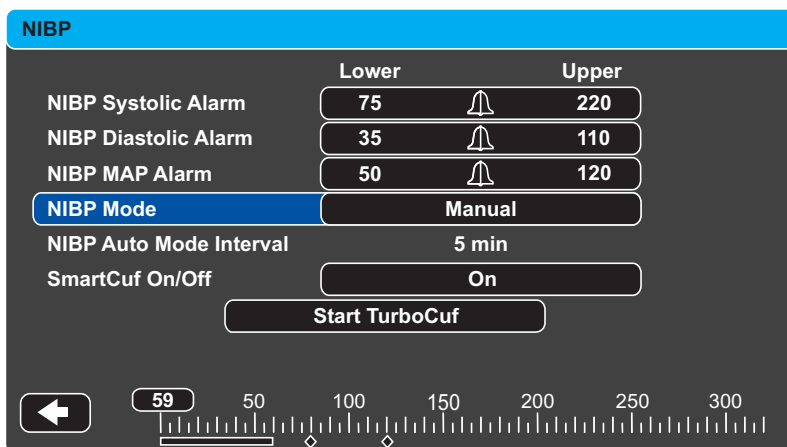


Figure 8-4 NIBP Parameter Control Menu

On the NIBP Parameter Control Panel, you can select an alarm configuration option (**SYS**, **DIA**, or **MAP**) to enable/disable alarms and set high and low alarm limits (as described previously).

You can also configure these NIBP options:

- NIBP Mode (**Mode**)
- NIBP Automatic Measurement Interval (**Auto Interval**)
- Enable/Disable Smartcuf motion artifact filter (**Smartcuf**)
- Start/Stop Turbocuf Measurements (**Turbocuf**)

Specify NIBP Mode

You can specify that the Propaq MD unit operate in either *Manual* or *Automatic Mode*.

In Manual Mode, the Propaq MD unit takes a single NIBP measurement when you press the **NIBP** button on the front panel (🔍). To repeat the NIBP measurement, you must press the **NIBP** key again (select **Manual**).

In Automatic Mode, the Propaq MD unit takes the first of a series of NIBP measurements when the **Auto Interval** timer expires, and then repeats the NIBP measurement at this specified interval.

Note: You can press the **NIBP** button and manually initiate an NIBP reading at any time while in Automatic Mode. Manually initiated NIBP readings will not affect the timing of subsequent NIBP readings in Automatic Mode.

Specify the Automatic NIBP Measurement Interval

You can specify the time interval between NIBP measurements in Automatic Mode. The default interval between measurements is 5 minutes.

You can specify intervals of **1, 2, 3, 5, 10, 15, 30**, and **60** minutes between NIBP measurements.

Enable/Disable Smartcuf Motion Artifact Filter

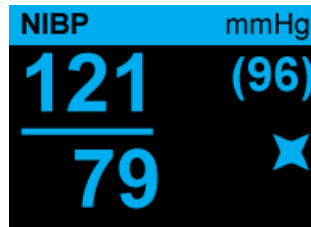
Enabling the use of the Smartcuf motion artifact filter increases the accuracy of NIBP measurements when motion artifact or weak pulses are present.

NIBP measurements can be adversely affected by many factors, such as cardiac arrhythmias, sudden changes in blood pressure, body motions such as shivering and convulsions, bumping the cuff, vibration, vehicle motion, or weak pulses. The Smartcuf filter synchronizes the NIBP reading with the R-wave of the patient's ECG to eliminate noise created by patient motion or vibration.

Note: The Propaq MD unit must perform ECG monitoring when using Smartcuf.

If artifact is severe, a special symbol appears on the display and printouts:

Figure 8-5 High Artifact Symbol



By default, Smartcuf is **Enabled**.

There are situations where you may choose to disable Smartcuf. These may include

- Very extreme motion artifact
- Certain types of arrhythmias
- Situations that prevent getting a ECG signal.

NIBP measurements can still be performed with Smartcuf disabled.

Start/Stop TurboCuf

Selecting **Start TurboCuf** starts Short-term Automatic (STAT) NIBP measurements. The Propaq MD unit begins its first NIBP measurement, after which it continues to perform as many NIBP measurements as possible over a 5-minute period.

Select **Stop TurboCuf** to immediately stop STAT measurements.

WARNING! Repeated use of STAT measurements on the same patient over a short time interval can affect blood pressure readings, limit circulation to the limb, and cause injury to the patient.

Setting the NIBP Display Format

You can specify the appearance of the NIBP numeric display format. The display format allows you to choose whether or not you will display MAP measurement (**M**) with the Systolic (**S**) and Diastolic (**D**) measurements in one of the following formats:

- **S/D**
- **S/D (M)** (default display)
- **(M) S/D**

Note: If a MAP alarm is active when the **S/D** format is selected, the display format will be **S/D (M)** until you clear the MAP alarm.

NIBP System Messages

When monitoring NIBP, the Propaq MD unit may display the following messages:

System Message	Cause
<i>READING IN PROGRESS</i>	The unit is taking an NIBP measurement and functioning normally.
<i>READING STOPPED</i>	The unit has stopped an NIBP measurement, because the operator has pressed the NIBP button and cancelled the measurement.
<i>READING FAILED</i>	The patient's pulse is too weak to obtain an NIBP measurement, or the cuff requires adjustment.
<i>ARTIFACT</i>	Excessive artifact is preventing the NIBP measurement. If ECG is available, consider turning SmartCuf on.
<i>NEONATE ALERT</i>	The unit has detected a neonate cuff when in Adult mode. Replace cuff or correct patient mode, as appropriate. If the detection is in error, dismiss the alert and reattempt the NIBP measurement.
<i>AIR LEAK</i>	A major air leak is preventing cuff inflation. Check hose and cuff connections, replace a defective hose or cuff, as necessary, and reattempt NIBP measurement.
<i>KINKED HOSE</i>	An air obstruction is preventing the correct operation of the unit. Check hose for kinks. If using a dual lumen hose, verify the correct placement of the O ring on the hose connector. Eliminate kinks or replace hose, if necessary.
<i>NIBP DISABLED</i>	A system error has occurred, and the Propaq MD unit should be serviced.
<i>PLEASE WAIT</i>	After completing an NIBP request in Automatic mode or STAT (TurboCuf) mode, the unit must wait up to 30 seconds before initiating the next NIBP measurement request.
<i>PRESS. LIMIT EXCEEDED</i>	The cuff pressure has exceeded the allowable limit. Restrict patient movement and check the hose for kinks. Eliminate kinks or replace the hose, if necessary.
<i>TEMP OUT OF RANGE</i>	The NIBP module is outside of its operating temperature range. Move unit to proper operating temperature and reattempt the NIBP measurement.
<i>WEAK PULSE</i>	The patient's pulse is too weak to obtain an NIBP measurement or the cuff requires adjustment.

Chapter 9

Monitoring CO₂

This chapter describes how to use the Propaq MD unit to monitor End Tidal Carbon Dioxide (EtCO₂), breath rate, and Fractional Inspired Carbon Dioxide (FiCO₂). These options use the same connector on the Propaq MD unit and may be used interchangeably.

Overview

The Propaq MD unit uses the Oridion Microstream FilterLine[®] and Smart CapnoLine[®] sidestream systems to monitor CO₂.

The FilterLine and Smart CapnoLine sidestream systems draw small samples of gas from the patient's airway via a nasal/oral cannula or airway adapter, and pass these gases through a solid state infrared sensor (located away from the patient's airway) that measures CO₂. The Microstream system can be used for CO₂ measurements on intubated and non-intubated infant, pediatric, and adult patients.

The Microstream CO₂ sensor generates infrared light, and beams it through the sampled breathing gases and determines CO₂ concentration by measuring the amount of light absorbed by gases.

The Propaq MD unit displays EtCO₂ (the concentration of carbon dioxide detected at the end of each exhalation) and FiCO as a numerical value in millimeters of mercury (mmHg). In addition, the unit can display a capnogram. The capnogram is a valuable clinical tool that can be used to assess patient airway integrity and proper endotracheal (ET) tube placement. The unit calculates respiration rate by measuring the time interval between detected peaks of the CO₂ waveform. The technology differentiates between waveforms caused by breathing and those caused by cardiogenic oscillations and artifact.

The Propaq MD is equipped with automatic barometric pressure compensation.

Warning!

- When using a sampling line for intubated patients with a closed suction system, do not place the airway adapter between the suction catheter and endotracheal tube. This is to ensure that the airway adapter does not interfere with the functioning of the suction catheter.
 - Do not cut or remove any part of the sample line. Cutting the sample line could lead to erroneous readings
 - If too much moisture enters the sampling line (i.e., from ambient humidity or breathing of unusually humid air), the message *Clearing FilterLine* will appear in the message area. If the sampling line cannot be cleared, the message *FilterLine Blockage* will appear in the message area. Replace the sampling line once the *FilterLine Blockage* message appears.
 - Do NOT use the Microstream sidestream CO₂ accessories in the presence of flammable anesthetics or other flammable gases.
 - Loose or damaged connections may compromise ventilation or cause an inaccurate measurement of respiratory gases. Securely connect all components and check connections for leaks according to standard clinical procedures.
 - Always ensure the integrity of the patient breathing circuit after insertion of the airway adapter by verifying a proper CO₂ waveform (capnogram) on the monitor display.
-

Caution


Microstream[®] EtCO₂ sampling lines are designed for single patient use, and are not to be reprocessed. Do not attempt to clean, disinfect, sterilize or flush any part of the sampling line as this can cause damage to the monitor.

Dispose of sampling lines according to standard operating procedures or local regulations for the disposal of contaminated medical waste.

Before use, carefully read the Microstream EtCO₂ sampling line's *Directions for Use*.

CO₂ Monitoring Setup and Use

Follow these steps to set up CO₂ monitoring:

1. Select the correct CO₂ sampling line for the patient.
2. Attach the sampling line to the unit's CO₂ inlet port.
3. Apply the Filterline airway adaptor or Smart CapnoLine Nasal or Nasal/Oral cannula to the patient.
4. Check that the Propaq MD unit is set up for the correct patient type -- Adult, Pediatric, or Neonate.
5. Configure alarms (if the current alarm settings are not appropriate) and other CO₂ features.
6. Press the **CO₂** quick access key () to initiate CO₂ monitoring.

Selecting the CO₂ Sampling Line

To select the correct CO₂ sampling line, you must determine the following:

- Is the patient adult, pediatric, or neonate?
- Is the patient intubated (ventilated) or non-intubated (non-ventilated)?

You can use the following Oridion Microstream accessories for sidestream CO₂ monitoring with the Propaq MD unit:

Table 7-1. Oridion Microstream CO₂ Sampling Lines for use with Propaq MD units.

Accessory	Type	Part Number
FilterLine Set (Adult/Pediatric), box of 25	Intubated sampling line and airway adapter for short term monitoring	8300-0520-01
FilterLine H Set (Adult/Pediatric), box of 25	Intubated sampling line and airway adapter for humid environments	8300-0521-01
FilterLine H Set (Infant/Neonate), box of 25	Intubated sampling line and airway adapter for humid environments	8300-0522-01
VitaLine H Set (Adult/Pediatric), box of 25	Intubated sampling line and airway adapter for high ambient humidity	8300-0523-01
Smart Capnoline Plus with O ₂ (Adult), box of 25	Non-Intubated Oral/Nasal sampling with O ₂ delivery	8300-0524-01
Smart Capnoline Plus with O ₂ (Pediatric), box of 25	Non-Intubated Dual Purpose	8300-0525-01

Warning! To ensure safe and reliable operation including biocompatibility, use only Microstream CO₂ accessories.

Connecting the CO₂ Sampling Lines

To connect the FilterLine or Smart CapnoLine:

1. Slide open the Propaq MD unit's CO₂ inlet port cover.
2. Put the fitting at the end of the sidestream tubing over the CO₂ inlet port connector.
3. Turn the fitting clockwise to tighten.



Figure 9-1 Connecting the Sampling Line Connector to the CO₂ Inlet Port

-
- Warning!**
- The exhaust port for the Microstream sidestream CO₂ apparatus is an output for only expired gases from the patient and any connected breathing apparatus. The exhaust port is intended only for connection to gas collection equipment, such as gas scavenger devices -- *there should be no other connections to the exhaust port.*
 - When connecting the Microstream sidestream CO₂ accessory to patients who are receiving or have recently received anesthetics, connect the CO₂ exhaust port to a scavenging system, or to the patient's anesthetic machine or ventilator to prevent exposing medical staff to anesthetics.
 - Do not lift the monitor by the FilterLine, as it could disconnect from the monitor, causing the monitor to fall on the patient.
 - The FilterLine may ignite in the presence of high O₂ concentrations when directly exposed to laser or ESU devices. Use caution when performing these procedures.
-

Note: If you use a gas scavenging system, ensure that it is installed according to the manufacturer's instructions. The gas scavenging system should comply with ISO 8835-3:1997 (E).

Note: In order to avoid moisture buildup and sampling line occlusion during nebulization or suction for intubated patients, remove the sampling line luer connector from the monitor.

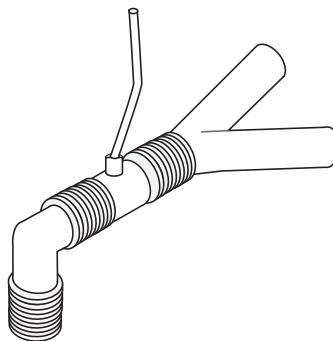
Applying a FilterLine Set

The FilterLine set is intended for the CO₂ monitoring of intubated patients.

Before attaching the airway adapter to the breathing circuit, verify that the adapter is clean, dry, and undamaged. Replace if necessary.

Caution The disposable FilterLine set is intended for single patient use. Do NOT reuse or sterilize any part of the FilterLine Set, as the monitor may be damaged by cleaning or reuse.

1. Place the airway adapter at the proximal end of the airway circuit between the elbow and the ventilator circuit wye. Do NOT place the airway adapter between the ET tube and the elbow as this may allow patient secretions to accumulate in the adapter.
2. If pooling does occur, the airway adapter may be removed from the circuit, rinsed with water and reinserted into the circuit. To prevent moisture from draining into the sample tubing, ensure that the sampling tube exits from the top of the airway adapter, not its bottom or sides. See the following figure.



Applying a Smart CapnoLine Nasal or Nasal/Oral Cannula

The nasal and nasal/oral cannulas are intended for monitoring CO₂ in non-intubated patients.

Oral/nasal sampling cannulas are especially valuable for patients who are prone to mouth breathing, since most (if not all) of the CO₂ is exhaled through the mouth. If a standard nasal CO₂ sampling cannula is used on such patients, the EtCO₂ values and capnogram displayed will be substantially lower than the actual CO₂ levels present in the patient's expired breath.

-
- Warning!**
- The disposable Smart CapnoLine nasal and nasal/oral cannula sets are intended for single patient use. Do NOT reuse or sterilize any part of this product, as the monitor may be damaged by reuse of the sampling line.
 - If oxygen is being delivered while using sidestream CO₂, be sure to use a CO₂ sampling with O₂ delivery. Using a different type of cannula will not enable oxygen delivery.
-

Remove the cannula from the package. Verify that the cannula is clean, dry, and undamaged. Replace if necessary.


Placing the Cannula onto the Patient

Place the oral/nasal cannula onto the patient as follows:



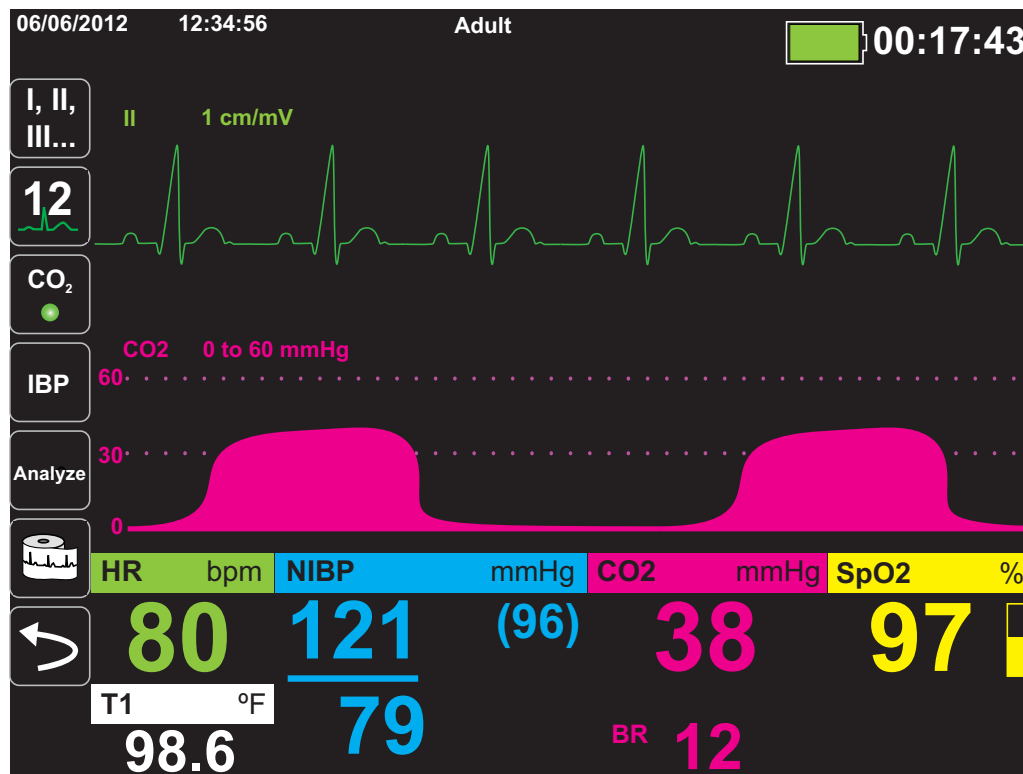
Caution Dispose of Microstream EtCO₂ consumables according to standard operating procedures or local regulations for the disposal of contaminated medical waste.

Measuring CO₂

Once setup is complete, press  to begin monitoring CO₂. The numeric CO₂ display appears on the screen and displays the message, *INITIALIZING*. The CO₂ display gives the current EtCO₂ value, and after a delay of approximately 1 minute, the patient's Respiration Rate (in Breaths/Minute), identified as **BR**:



Check that connections have been made correctly by verifying the display a proper capnogram (the waveform is inserted automatically on the waveform display window).




Setting CO₂ and Respiration Rate Alarms

The Propaq MD unit sounds alarms whenever measurements are outside set limits for the following:





- High and Low EtCO₂
- High and Low Respiration Rate (in Breaths/Minute)
- High FiCO₂
- No Breath Alarm

Note: Use the Resp Parameter Control Panel to set the duration of the No Breath Alarm, or to disable it (see “Using the Resp Parameter Control Panel” on page 7-4).

Enabling/Disabling Alarms and Setting CO₂ Alarm Limits

You can enable (or disable) CO₂ alarms and set upper and lower alarm limits through the Alarms quick access key () or the CO₂ Parameter Control Panel.

To configure CO₂ alarms through the Alarms quick access key:

1. Press the **More** quick access key ()
2. Press .
3. Press the **Limits** quick access key ()
4. Use the navigation buttons to select appropriate alarm menu. For CO₂, the alarm menus are: EtCO₂ Alarm, FiCO₂ Alarm, or RR/BR Alarm.
5. On the alarm settings menu, use the navigation keys to select the fields that you want to change. The fields are
 - **Upper Limit Enable**
 - **Lower Limit Enable (only EtCO₂ and RR/BR Alarms)**
 - **Upper Limit**
 - **Lower Limit (only EtCO₂ and RR/BR Alarms)**
6.  When you are finished changing values on the alarm menu, select the Backarrow key to exit the menu.

Setting Upper and Lower EtCO₂ Limits

Initially, the EtCO₂ Alarm menu specifies that the EtCO₂ alarms are enabled (**ON**) or disabled (**OFF**), and displays the default Upper and Lower EtCO₂ Limits. The upper and lower limits can be **ON** or **OFF** (default is **OFF**). The following table lists the default EtCO₂ limits for adult, pediatric, and neonate patients, and gives the range in which you can set these limits:

Patient Type	EtCO ₂ Limit Default	EtCO ₂ Limit Range
Adult	Lower: 8 mmHg Upper: 60 mmHg	Lower: 0-145 mmHg Upper: 5-150 mmHg
Pediatric	Lower: 8 mmHg Upper: 60 mmHg	Lower: 0-145 mmHg Upper: 5-150 mmHg
Neonate	Lower: 8 mmHg Upper: 60 mmHg	Lower: 0-145 mmHg Upper: 5-150 mmHg

Caution

In high-altitude environments, EtCO₂ values may be lower than values observed at sea level, as described by Dalton's law of partial pressures. When using the Propaq MD unit in high-altitude environments, it is advisable to adjust EtCO₂ alarm settings accordingly.

Setting Upper FiCO₂ Limits

Initially, the FiCO₂ Alarm menu specifies that the FiCO₂ alarms are enabled (**ON**) or disabled (**OFF**), and displays the default upper limit. The upper limit can be **ON** or **OFF** (default is **OFF**). The following table lists the default FiCO₂ upper limits for adult, pediatric, and neonate patients, and gives the range in which you can set these limits:

Patient Type	Upper FiCO ₂ Limit Default	Upper FiCO ₂ Limit Range
Adult	8 mmHg	2-98 mmHg
Pediatric	8 mmHg	2-98 mmHg
Neonate	8 mmHg	2-98 mmHg

Setting Upper and Lower Respiratory Rate (RR/BR) Limits

Initially, the RR/BR Alarm menu specifies that RR/BR alarms are enabled (**ON**) or disabled (**OFF**), and displays the default Upper and Lower respiratory limits. The upper and lower limits can be **ON** or **OFF** (default is **OFF**). The following table lists the default Respiratory limits for adult, pediatric, and neonate patients in Breaths/Minute, and gives the range in which you can set these limits:

Patient Type	Respiration Rate Default	Respiration Rate Range
Adult	Lower: 3 BPM Upper: 50 BPM	Lower: 0 to 145 BPM Upper: 5 to 150 BPM
Pediatric	Lower: 3 BPM Upper: 50 BPM	Lower: 0 to 145 BPM Upper: 5 to 150 BPM
Neonate	Lower: 12 BPM Upper: 80 BPM	Lower: 0 to 145 BPM Upper: 5 to 150 BPM

Using the CO2 Parameter Control Panel

Use the navigation keys to highlight and select the **CO2** numeric display to display the CO2 Parameter Control Panel:

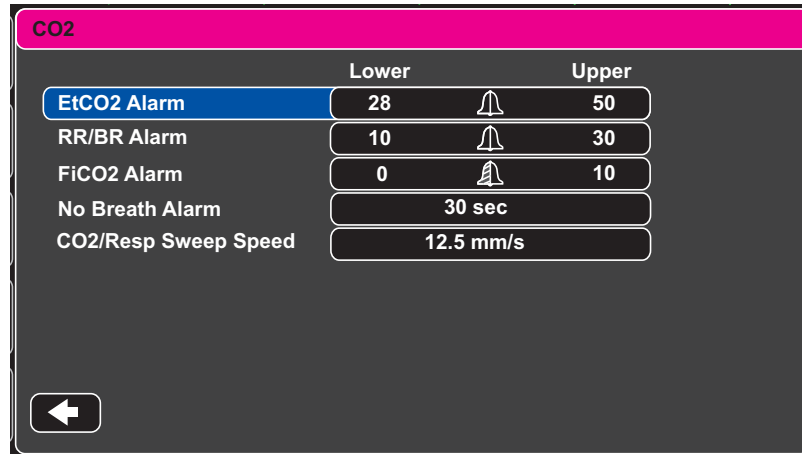


Figure 9-2 CO2 Parameter Control Menu

On the CO2 Parameter Control Panel, you can select a CO₂ alarm (EtCO₂, Breath Rate, or FiCO₂). On the selected alarm settings menu, you can enable/disable alarms and set alarm limits (as described previously). You can also set the CO₂ sweep speed.

Setting the CO₂ Sweep Speed

The EtCO₂ sweep speed determines the X-axis scale of the capnogram. For patients with slower respiration rates, a slower sweep speed will make the capnogram easier to view. You can specify sweep speeds of 3.13, 6.25, and 12.5 mm/second. The default sweep speed is 6.25 mm/second.

System Messages

When monitoring CO₂, the Propaq MD unit may display the following messages:

System Message	Cause
<i>INITIALIZING</i>	The unit is initializing the CO ₂ monitoring function measurement, is functioning normally, and will display CO ₂ measurement after a brief delay.
<i>CHECK FILTERLINE</i>	The sampling line is not connected. Check sampling line connection. Replace airway adaptor or cannula, if defective.
<i>FILTERLINE OCCLUSION</i>	The sampling or exhaust line is blocked. Check sampling and exhaust lines. Make sure that the sampling line and any inputs to the patient breathing apparatus are not connected to the exhaust port. If the current FilterLine is correctly attached, replace the FilterLine.
<i>AUTO ZERO</i>	The Propaq MD unit displays <i>AUTO ZERO</i> when the CO ₂ module performs periodic self-maintenance. During self-maintenance, the CO ₂ module performs one or more of the following tests: ambient pressure measurement, auto zero, and a flow test. The CO ₂ module completes its self-maintenance tests in approximately 10 seconds.
<i>PURGING</i>	The CO ₂ module performs a purging whenever it detects an occlusion in the line or airway adaptor, and displays <i>PURGING</i> while it tries to clear the occlusion. If the CO ₂ module cannot clear the occlusion within 30 seconds, the Propaq MD unit issues an equipment alert and displays the message <i>FILTERLINE OCCLUSION</i> . At this point, if the current FilterLine is correctly attached, replace the FilterLine.
<i>VALUE OVER RANGE</i>	The CO ₂ value exceeds the specified range.
<i>CO2 DISABLED</i>	An error has occurred with the CO ₂ module, and the Propaq MD unit has disabled the module for the duration of the unit's power cycle. If the problem persists, the unit may require servicing.
<i>CO2 MONITORING FAILURE</i>	The Propaq MD unit has determined that the CO ₂ module is not functioning correctly. If the problem persists, the unit may require servicing.

Patents

The capnography component of the Propaq MD unit is covered by one or more of the following US patents: 6,428,483; 6,997,880; 5,300,859; 6,437,316; 7,488,229; and their foreign equivalents. Additional patent applications pending.

NO IMPLIED LICENSE

Possession or purchase of this device does not convey any express or implied license to the device with unauthorized consumable CO₂ sampling consumable products, which would, alone, or in combination with this device, fall within the scope of one or more of the patents relating to this device and/or CO₂ sampling consumable products.

Chapter 10

Pulse CO-Oximetry (SpO₂)

The Propaq MD SpO₂ input is Type CF defibrillator proof.

This chapter describes how to use the Propaq MD unit to monitor Pulse CO-Oximetry (SpO₂), as well as the optional features: SpCO, and SpMet, and SpHb, SpOC PVI, and PI.

The Propaq MD pulse CO-Oximeter continuously and noninvasively measures the following at a peripheral site, such as the foot, toe, or finger:

- Oxygen saturation of arterial hemoglobin (SpO₂)
- Carboxyhemoglobin saturation (SpCO)
- Methemoglobin saturation (SpMet)
- Total Hemoglobin (SpHb)
- Oxygen Content (SpOC)
- Pleth Variability Index (PVI)
- Perfusion Index (PI)

This monitoring gives information about the cardiac and respiratory systems, and provides details of oxygen transportation in the body. It is widely used because it is noninvasive, continuous, easily applied, and painless.

The Propaq MD pulse CO-oximetry option is intended for use only with ZOLL / Masimo Rainbow sensors. The CO-oximetry sensor contains light-emitting diodes (LEDs) that transmit various visible and infrared light through the body's extremities. The transmitted light is then received by a photodetector, which converts it to an electronic signal. The signal is then sent to the Propaq MD unit for processing.

Oxygen-saturated blood absorbs light differently than unsaturated blood. Thus the amount of visible and infrared light absorbed by blood flowing through a suitable peripheral area of the body, typically the finger in adults and the foot in neonates, can be used to calculate the ratio of oxygenated hemoglobin to total hemoglobin in arterial blood. The monitor displays this ratio as a percent (normal values typically range from 95% to 100% at sea level) alternating with SpCO and SpMet, and SpHb, SpOC, PVI and PI values if available on your unit.

Note: The monitor does not display SpCO values when you use a SpHb sensor and does not display SpHb values when you use a SpCO sensor.

The measurements rely on multiwavelength calibration equations to estimate the:

- Percentage of carboxyhemoglobin in arterial blood (SpCO).
- Percentage of methemoglobin in arterial blood (SpMet).
- Total hemoglobin concentration present in the blood (SpHb).
- Total oxygen content present in the blood (SpOC).
- Peripheral perfusion changes secondary to respiration (PVI).
- The arterial pulse strength as the percentage of pulsatile signal to non-pulsatile signal (PI).

The quality of measurements depends on the correct size and application of the sensor, adequate blood flow through the sensor site, and the sensor's exposure to ambient light. For correct placement and location of the sensors, refer to the *Directions for Use* contained with all Rainbow oximetry sensor packages.

Warnings -- SpO₂ General

- As with all medical equipment, carefully route patient cabling to reduce the possibility of patient entanglement or strangulation.
- Do not place the pulse co-oximeter or accessories in any position that might cause it to fall on the patient.
- Do not start or operate the pulse co-oximeter unless the setup was verified to be correct.
- Do not use the pulse co-oximeter during magnetic resonance imaging (MRI) or in an MRI environment.
- Do not use the pulse co-oximeter if it appears or is suspected to be damaged.
- Explosion hazard: Do not use the pulse co-oximeter in the presence of flammable anesthetics or other flammable substance in combination with air, oxygen-enriched environments, or nitrous oxide.
- To ensure safety, avoid stacking multiple devices or placing anything on the instrument during operation.
- To protect against injury, follow the directions below:
 - Avoid placing the device on surfaces with visible liquid spills.
 - Do not soak or immerse the device in liquids.
 - Do not attempt to sterilize the device.
 - Use cleaning solutions only as instructed in this operator's manual.
 - Do not attempt to clean the device while monitoring patient.
- To protect from electric shock, always remove the sensor and completely disconnect the pulse co-oximeter before bathing the patient.
- If any measurement seems questionable, first check the patient's vital signs by alternate means and then check the pulse co-oximeter for proper functioning.
- Inaccurate respiration rate measurements may be caused by:
 - Improper sensor application
 - Low arterial perfusion
 - Motion artifact
 - Low arterial oxygen saturation
 - Excessive ambient or environmental noise
- Inaccurate SpCO and SpMet readings can be caused by:
 - Improper sensor application
 - Intravascular dyes such as indocyanine green or methylene blue
 - Abnormal hemoglobin levels
 - Low arterial perfusion
 - Low arterial oxygen saturation levels including altitude induced hypoxemia
 - Elevated total bilirubin levels
 - Motion artifact

- Inaccurate SpHb and SpOC readings may be caused by:
 - Improper sensor application
 - Intravascular dyes such as indocyanine green or methylene blue
 - Externally applied coloring and texture such as nail polish, acrylic nails, glitter, etc.
 - Elevated PaO₂ levels
 - Elevated levels of bilirubin
 - Low arterial perfusion
 - Motion artifact
 - Low arterial oxygen saturation levels
 - Elevated carboxyhemoglobin levels
 - Elevated methemoglobin levels
 - Hemoglobinopathies and synthesis disorders such as thalassemias, Hb s, Hb c, sickle cell, etcetera
 - Vasospastic disease such as Raynaud's
 - Elevated altitude
 - Peripheral vascular disease
 - Liver disease
 - EMI radiation interference
- Inaccurate SpO₂ readings may be caused by:
 - Improper sensor application.
 - Elevated levels of COHb or MetHb: High levels of COHb or MetHb may occur with a seemingly normal SpO₂. When elevated levels of COHb or MetHb are suspected, laboratory analysis (co-Oximetry) of a blood sample should be performed.
 - Intravascular dyes, such as indocyanine green or methylene blue.
 - Externally applied coloring and texture, such as nail polish, acrylic nails, glitter, etc.
 - Elevated levels of bilirubin
 - Severe anemia
 - Low arterial perfusion
 - Motion artifact
- Interfering Substances: Dyes or any substance containing dyes that change usual blood pigmentation may cause erroneous readings.
- The pulse co-oximeter is intended only as an adjunct device in patient assessment. It should not be used as the sole basis for diagnosis or therapy decisions. It must be used in conjunction with clinical signs and symptoms.
- The pulse co-oximeter is not an apnea monitor.
- The pulse co-oximeter may be used during defibrillation, but this may affect the accuracy or availability of the parameters and measurements.
- The pulse co-oximeter may be used during electrocautery, but this may affect the accuracy or availability of the parameters and measurements.
- The pulse co-oximeter should not be used for arrhythmia analysis

-
- To protect from electric shock, always remove the sensor and completely disconnect the pulse co-oximeter before bathing the patient.
 - SpCO readings may not be provided if there are low arterial saturation levels or elevated methemoglobin levels.
 - SpO₂, SpCO, SpMet, and SpHb are empirically calibrated in healthy adult volunteers with normal levels of carboxyhemoglobin (COHb) and methemoglobin (MetHb).
 - Do not adjust, repair, open, disassemble, or modify the pulse co-oximeter or accessories. Injury to personnel or equipment damage could occur. Return the pulse co-oximeter for servicing if necessary.

Cautions

- Do not place the pulse co-oximeter where the controls can be changed by the patient.
- Electrical shock and flammability hazard: Before cleaning, always turn off the instrument and disconnect from any power source.
- When patients are undergoing photodynamic therapy they may be sensitive to light sources. Pulse oximetry may be used only under careful clinical supervision for short time periods to minimize interference with photodynamic therapy.
- Do not place the pulse co-oximeter on electrical equipment that may affect the instrument, preventing it from working properly.
- If SpO₂ values indicate hypoxemia, a laboratory blood sample should be taken to confirm the patient's condition.
- If the Low Perfusion message is frequently displayed, find a better perfused monitoring site. In the interim, assess the patient and, if indicated, verify oxygenation status through other means.
- If using pulse oximetry during full body irradiation, keep the sensor out of the radiation field. If the sensor is exposed to the radiation, the reading might be inaccurate or the instrument might read zero for the duration of the active irradiation period.
- The instrument must be configured to match your local power line frequency to allow for the cancellation of noise introduced by fluorescent lights and other sources.
- To ensure that alarm limits are appropriate for the patient being monitored, check the limits each time the pulse co-oximeter is used.
- Variation in hemoglobin measurements may be profound and may be affected by sampling technique as well as the patient's physiological conditions. Any results exhibiting inconsistency with the patient's clinical status should be repeated and/or supplemented with additional test data. Blood samples should be analyzed by laboratory instruments prior to clinical decision making to completely understand the patient's condition.
- Do not submerge the pulse co-oximeter in any cleaning solution or attempt to sterilize by autoclave, irradiation, steam, gas, ethylene oxide or any other method. This will seriously damage the pulse co-oximeter.

- **Electrical Shock Hazard:** Carry out periodic tests to verify that leakage currents of patient-applied circuits and the system are within acceptable limits as specified by the applicable safety standards. The summation of leakage currents must be checked and in compliance with IEC 60601-1 and UL60601-1. The system leakage current must be checked when connecting external equipment to the system. When an event such as a component drop of approximately 1 meter or greater or a spillage of blood or other liquids occurs, retest before further use. Injury to personnel could occur.
- **Disposal of product -** Comply with local laws in the disposal of the instrument and/or its accessories.
- To minimize radio interference, other electrical equipment that emits radio frequency transmissions should not be in close proximity to the pulse co-oximeter.

SpO₂ Setup and Use

To take accurate SpO₂ measurements using the Propaq MD unit, you must perform the following steps, each of which corresponds to a section in this chapter.

1. Select the correct sensor.
2. Apply the sensor to the patient.
3. Connect the sensor to the Propaq MD unit.
4. Configure alarms and settings (if the current alarms and settings are not appropriate).

Pulse oximetry measurements begin as soon as the sensor is applied to the patient and connected to the Propaq MD unit.

Selecting the SpO₂ Sensor

When selecting the sensor, consider the patient's weight, the adequacy of perfusion, the available sensor sites, and the anticipated duration of monitoring. For more information, refer to the *Accessories* section of this chapter, which provides a list of ZOLL-approved reusable and single-use sensors for adult, pediatric, and neonate patients. Before applying the sensor, always familiarize yourself with the *Directions for Use* that the manufacturer provides with the sensor.

Note: An SpHb sensor is required for measuring the optional SpHb and SpOC parameters. The monitor does not display SpCO values when you use a SpHb sensor and does not display SpHb values when you use a SpCO sensor.

Applying the SpO₂ Sensor

Choose a site that is well perfused and restricts a conscious patient's movements the least. The ring finger or middle finger of the nondominant hand is preferred.

Alternatively, you can use the other digits on the nondominant hand. Be sure the sensor's detector is fully covered by flesh. You can use the great toe or long toe (next to the great toe) on restrained patients or patients whose hands are unavailable.

To prevent interference from ambient light, ensure that the sensor is properly applied, and cover the sensor site with opaque material, if required. Failure to take this precaution in high ambient light conditions may result in inaccurate measurements.

Do not select an SpO₂ sensor site on the same arm/leg as an NIBP cuff. Inflation of the cuff will cause the SpO₂ values to read incorrectly.

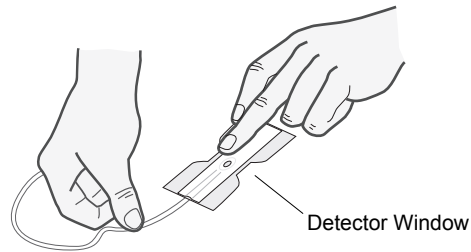
Applying a Two-Piece Single-Use Sensor/Cable

When applying a single-use sensor, be careful not to wrap the adhesive too tightly as this can cause venous pulsations that could lead to inaccurate saturation measurements.

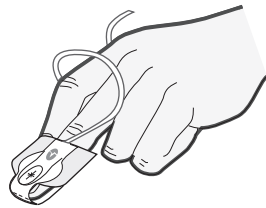
1. Remove plastic backing from the sensor and locate transparent windows on the adhesive side. The transparent windows cover the optical components.

Note: When selecting a sensor site, priority should be given to an extremity free of an arterial catheter, blood pressure cuff, or intravascular infusion line.

2. Orient the sensor so the dashed line in the middle of the sensor is centered on the tip of the digit. Wrap adhesive flaps on non-cable end around the digit.



3. Fold cable end over top of digit so that windows are directly opposite each other. Wrap adhesive securely around sides of digit.



Note: If the sensor does not track the pulse reliably, it may be incorrectly positioned or the sensor site may be too thick, thin, or deeply pigmented, or otherwise deeply colored (for example, as a result of externally applied coloring such as nail polish, dye, or pigmented cream) to permit appropriate light transmission. If any of these situations occurs, reposition the sensor or choose an alternate sensor for use on a different site.

4. Lift the clear plastic protective cover from the female end of the extension cable, then plug the sensor cable's male connector into the extension cable connector -- make sure that the plug is all the way into the connector:

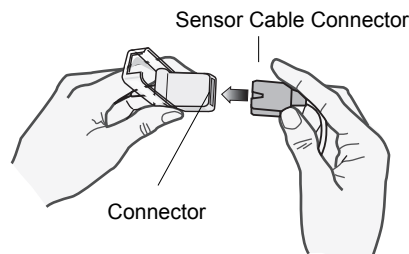


Figure 10-1 Plug the Sensor Connectors Together

5. Lower the clear plastic cover over the connection to secure it:

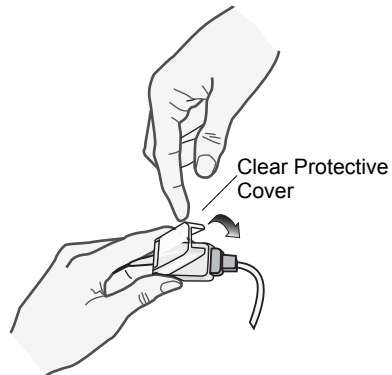


Figure 10-2 Lower Plastic Cover Over Cable Connection

6. See “Connecting the SpO₂ Sensor” on page 10-10 to connect the cable to the unit.

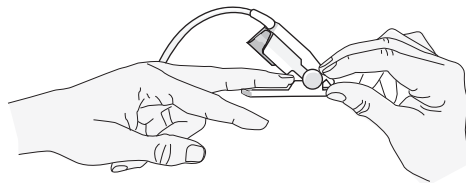
Applying a Reusable Sensor/Cable

The following instructions describe how to apply a reusable Rainbow sensor. For correct placement and location of the sensors, refer to the *Directions for Use* contained with all Rainbow oximetry sensor packages.

For all other reusable sensors, refer to the sensor packaging and the manufacturer's *Directions for Use* for instructions on how to apply the sensor.

After selecting a monitoring site, apply the reusable sensor as follows:

1. Place the selected digit over the sensor window, making sure that the sensor cable runs over the top of the patient's hand.
2. On finger sites, make sure the tip of the finger touches the raised digit stop inside the sensor. If the fingernail is long, it may extend over and past the finger stop.



3. Check the sensor position to ensure that the top and bottom halves of the sensor are parallel. To ensure accurate data, you must have complete coverage of the detector window.



Note: With smaller digits, the digit may not need to be pushed all the way to the stop to completely cover the detector window.

4. Based on the type of patient cable you are using, do one of the following:
 - If you are using a direct one-piece patient cable, see “Connecting the SpO2 Sensor” on page 10-10.
 - If you are using the two-piece patient cable, lift the clear plastic protective cover from the female end of the extension cable, then plug the sensor cable's male connector into the extension cable connector -- make sure that the plug is all the way into the connector (see Figure 10-1).
5. Lower the clear plastic cover over the connection to secure it (see Figure 10-2).
6. See “Connecting the SpO2 Sensor” on page 10-10 to connect the cable to the unit.

Cleaning and Reuse of Sensors

Reusable sensors can be cleaned as follows:

Disconnect the sensor from the patient cable, if appropriate. Wipe the entire sensor clean with a 70% isopropyl alcohol moistened pad. Allow the sensor to air dry before returning it to use.

Connecting the SpO₂ Sensor

To connect the sensor to the Propaq MD unit:

1. When using a sensor extension cable, inspect the cable before use. Replace the cable if it shows any signs of wear, breakage, or fraying. Plug the sensor extension cable into the SpO₂ receptacle on the side of the Propaq MD unit:

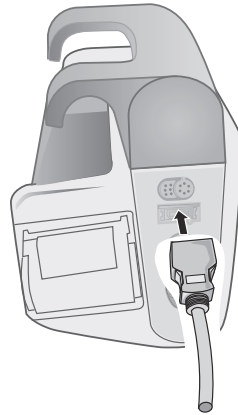
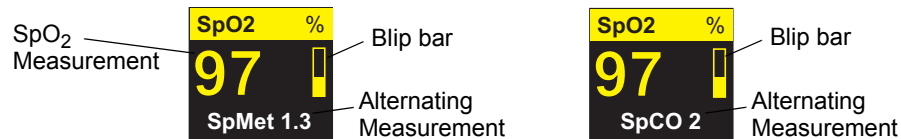


Figure 10-3 Connecting the SpO₂ Sensor to the Propaq MD Unit

Displaying Measurements

When the connection is made between the sensor and the unit, the message, *INITIALIZING*, appears in the display. After a brief delay, the unit displays the measurement. If SpCO and SpHb, SpOC, PVI and PI are installed and monitoring is on for these parameters, the measurements will alternate every two seconds underneath the display.




Note: SpHb and SpOC measurements require an SpHb sensor. The monitor does not display SpCO values when you use a SpHb sensor and does not display SpHb values when you use a SpCO sensor.

If the message, *SENSOR FAILURE*, appears, the sensor is either incompatible with the Propaq MD unit, or it is not working, and you will need to replace the sensor.





A blip bar appears on the right side of the SpO₂ numeric display window. The blip bar indicates the pulse derived from the plethysmograph normalized waveform.

Enabling/Disabling SpO₂ Alarms and Setting Alarm Limits

When enabled, the Propaq MD unit sounds alarms whenever measurements are outside set limits for the high and low SpO₂ values (and, if installed and monitoring is on, SpCO and SpMet, and SpHb, SpOC, PVI and PI values).

You can enable (or disable) alarms and set Upper and Lower alarm limits through the Alarms quick access key () or through the SpO₂ Parameter Control Panel.

To configure alarms through the Alarms quick access key:

1. Press the **More** quick access key ()
2. Press .
3. Press the **Limits** quick access key ()
4. Use the navigation buttons to highlight and select the appropriate alarm menu selection (SpCO, SpMet, SpHb, SpOC, PVI, PI).
5. On the selected Alarm Settings menu, use the navigation keys to select the fields that you want to change. The fields are
 - Upper Limit Enable
 - Lower Limit Enable
 - Upper Limit
 - Lower Limit
6. When you are finished changing values on the alarm menu, navigate to the Backarrow key () to exit the menu.

Note: If you set the SpO₂ low alarm limit below the low limit default (85%), the Propaq MD issues an equipment alert.

Setting Upper and Lower SpO₂ Alarm Limits

Initially, the SpO₂ Alarm Settings menu specifies whether the SpO₂ alarms are enabled (**ON**) or disabled (**OFF**), and displays the default upper and lower SpO₂ limits. The upper and lower limits can be **ON** or **OFF** (default is **OFF**). The following table lists the default SpO₂ limits for adult, pediatric, and neonate patients, and gives the range in which you can set these limits.

Patient Type	SpO ₂ Limit Default	SpO ₂ Limit Range
Adult	Lower: 85% Upper: 100%	Lower: 50 - 98% Upper: 52 - 100%
Pediatric	Lower: 85% Upper: 100%	Lower: 50 - 98% Upper: 52 - 100%
Neonate	Lower: 85% Upper: 95%	Lower: 50 - 98% Upper: 52 - 100%

Setting Upper and Lower SpCO and SpMet Alarm Limits

The following table lists the default SpCO and SpMet limits for adult, pediatric, and neonate patients, and gives the range in which you can set these limits.

Patient Type	SpCO Limit Default	SpCO Limit Range	SpMet Limit Default	SpMet Limit Range
Adult	Lower: 0% Upper: 10%	Lower: 0- 98% Upper: 2 - 100%	Lower: 0% Upper: 3%	Lower: 0- 98% Upper: 2 - 100%
Pediatric	Lower: 0% Upper: 10%	Lower: 0 - 98% Upper: 2 - 100%	Lower: 0% Upper: 3%	Lower: 0- 98% Upper: 2 - 100%
Neonate	Lower: 0% Upper: 10%	Lower: 0 - 98% Upper: 2 - 100%	Lower: 0% Upper: 3%	Lower: 0- 98% Upper: 2 - 100%

Setting Upper and Lower SpHb Alarm Limits

The following table lists the default SpHb limits for adult, pediatric, and neonate patients, and gives the range in which you can set these limits

Patient Type	SpHb Limit Default	SpHb Limit Range
Adult	Lower: 7.0 g/dL 4.0 mmol/L Upper: 17.0 g/dL 11.0 mmol/L	Lower: 0 - 24.9 g/dL 0 - 15.4 mmol/L Upper: 2 - 25 g/dL 2 - 15.5 mmol/L
Pediatric	Lower: 7.0 g/dL 4.0 mmol/L Upper: 17.0 g/dL 11.0 mmol/L	Lower: 0 - 24.9 g/dL 0 - 15.4 mmol/L Upper: 2 - 25 g/dL 2 - 15.5 mmol/L
Neonate	Lower: 7.0g/dL 4.0 mmol/L Upper: 17.0 g/dL 11.0 mmol/L	Lower: 0 - 24.9 g/dL 0 - 15.4 mmol/L Upper: 2 - 25 g/dL 2 - 15.5 mmol/L

Setting Upper and Lower SpOC Alarm Limits

The following table lists the default SpOC limits for adult, pediatric, and neonate patients, and gives the range in which you can set these limits

Patient Type	SpOC Limit Default	SpOC Limit Range
Adult	Lower: 10 ml/dL Upper: 25 ml/dL	Lower: 0 - 34.9 ml/dL Upper: 0.1 - 35 ml/dL
Pediatric	Lower: 10 ml/dL Upper: 25 ml/dL	Lower: 0 - 34.9 ml/dL Upper: 0.1 - 35 ml/dL
Neonate	Lower: 10 ml/dL Upper: 25 ml/dL	Lower: 0 - 34.9 ml/dL Upper: 0.1 - 35 ml/dL

Setting Upper and Lower PVI Alarm Limits

The following table lists the default PVI limits for adult, pediatric, and neonate patients, and gives the range in which you can set these limits

Patient Type	PVI Limit Default	PVI Limit Range
Adult	Lower: 5% Upper: 40%	Lower: 0 - 98% Upper: 2 - 100%
Pediatric	Lower: 5% Upper: 40%	Lower: 0 - 98% Upper: 2 - 100%
Neonate	Lower: 5% Upper: 40%	Lower: 0 - 98% Upper: 2 - 100%

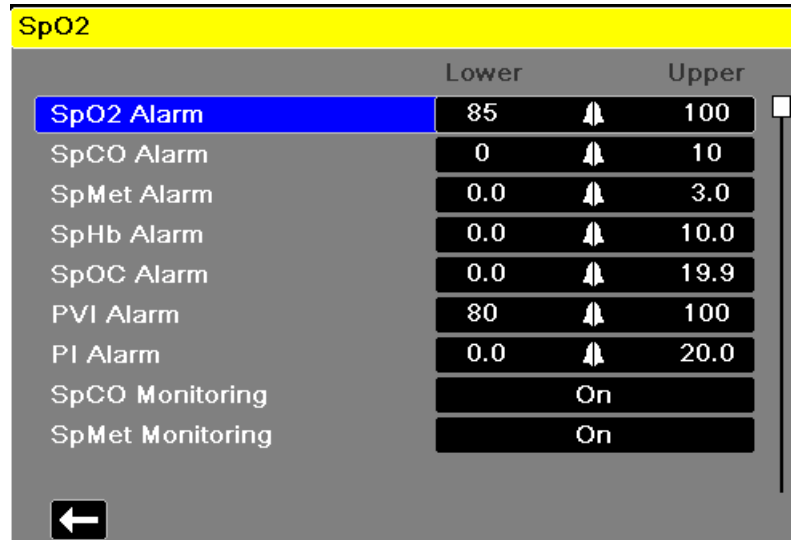
Setting Upper and Lower PI Alarm Limits

The following table lists the default PI limits for adult, pediatric, and neonate patients, and gives the range in which you can set these limits

Patient Type	PI Limit Default	PI Limit Range
Adult	Lower: 0% Upper: 20%	Lower: 0 - 19.8% Upper: 0.2 - 20%
Pediatric	Lower: 0% Upper: 20%	Lower: 0 - 19.8% Upper: 0.2 - 20%
Neonate	Lower: 0% Upper: 20%	Lower: 0 - 19.8% Upper: 0.2 - 20%

Using the SpO₂ Parameter Control Panel

Use the navigation keys to highlight and select the SpO₂ numeric display to display the SpO₂ Parameter Control Panel, where you can select options that optimize the use of SpO₂ for the patient:



SpCO and SpMet, and SpHb, SpOC, PVI and PI Monitoring

If the SpCO and SpMet or the SpHb, SpOC, PVI and PI options are installed on your unit you can enable or disable monitoring these parameters on the SpO₂ Control Panel.

Specifying the SpO₂ Averaging Time

The Masimo SpO₂ module in the Propaq MD unit provides three different time periods over which SpO₂ values are averaged: 4 seconds, 8 seconds (default) and 16 seconds. The averaging period is rarely changed from the 8 second default setting. For high risk patients with rapidly changing SpO₂ conditions, use the 4 second setting. Use the 16 second setting only when the 8 second setting (default) is inadequate due to extremely high artifact conditions.

Selecting the SpO₂ Sensitivity

You can select either normal or high sensitivity for SpO₂ monitoring. The Normal sensitivity setting is recommended setting for most patients. The High sensitivity setting allows you to monitor SpO₂ even under very low perfusion conditions. Such conditions may include severe hypotension or shock. With the High sensitivity setting, however, SpO₂ results are more easily contaminated by artifact. To ensure accurate SpO₂ readings when using the High sensitivity setting, observe the patient carefully and continuously.

Selecting SpHb Venous Mode

If the SpHb option is installed, the Propaq MD unit allows you to specify whether to use venous mode (**On**) as the blood sample source or not (**Off**). When **Off** (default) the Propaq MD uses arterial as the blood sample source.

Specifying the SpHb Averaging Time

If the SpHb option is installed, the Propaq MD unit allows you to choose the time period over which SpHb values will be calculated: **Short**, **Medium**, and **Long** (default). Averaging time represents the approximate time period the Propaq MD will use to calculate SpHb values. Longer averaging times allow you to see subtle changes in the SpHb value and tend to improve accuracy.

Selecting the Heart Rate/ Pulse Rate (HR/PR) Tone

The unit allows you enable or disable the tone that the monitor uses to indicate detection of the patient's pulse: **On** or **Off** (no tone sounds). The default tone is **Off**.

SpO2 System Messages

The Propaq MD unit may display the following system messages when monitoring SpO₂:

System Message	Cause
<i>INITIALIZING</i>	The SpO ₂ pulse oximeter is initializing.
<i>SEARCHING</i>	The unit is searching for a pulse.
<i>CHECK SENSOR</i>	The SpO ₂ sensor has become disconnected from the unit, or the sensor is no longer on the patient. Check sensor and then reconnect it to the unit or reapply it to the patient.
<i>SENSOR FAILURE</i>	The SpO ₂ sensor is defective. Replace the sensor.
<i>CABLE FAILURE</i>	The SpO ₂ cable is defective. Replace the cable.
<i>LIFE EXPIRING</i>	Adhesive/Sensor/Cable Failure. The adhesive/sensor/cable is nearing expiration. Replace the adhesive/sensor/cable.
<i>LOW PERFUSION</i>	Signal too small, move to better perfused site.
<i>SPO2 DISABLED</i>	A system error has occurred. The Propaq MD unit cannot take SpO ₂ measurements and should be serviced.
<i>TIME LEFT: XX:X HRS</i>	For sensors that support expiration, indicates the approximate time left before sensor expiration.

Functional Testers and Patient Simulators

Some models of commercially available bench top functional testers and patient simulators can be used to verify the proper functionality of Masimo pulse oximeter sensors, cables and monitors. See the individual testing device's operator's manual for the procedures specific to the model of tester that you are using.

While such devices may be useful for verifying that the pulse oximeter sensor, cable, and monitor are functional, they are incapable of providing the data required to properly evaluate the accuracy of a system's SpO₂ measurements.

Fully evaluating the accuracy of the SpO₂ measurements requires, at a minimum, accommodating the wavelength characteristics of the sensor and reproducing the complex optical interaction of the sensor and the patient's tissue. These capabilities are beyond the scope of known bench top testers, including known devices which claim to measure sensor LED wavelength.

SpO₂ measurement accuracy can only be evaluated in vivo by comparing pulse oximeter readings with values traceable to SpO₂ measurements obtained from simultaneously sampled arterial blood using a laboratory CO-oximeter.

Many functional testers and patient simulators have been designed to interface with the pulse oximeter's expected calibration curves and may be suitable for use with Masimo monitors and/or sensors. Not all such devices, however, are adapted for use with the Masimo digital calibration system. While this will not affect use of the simulator for verifying system functionality, displayed SpO₂ measurement values may differ from the setting of the test device.

For a properly functioning monitor, this difference will be reproducible over time and from monitor to monitor within the performance specifications of the test device.

Patents

All patent information related to the SpO₂ component of the Propaq MD unit can be found at the following:

www.masimo.com/patents.htm

NO IMPLIED LICENSE

Possession or purchase of this device does not convey any express or implied license to use the device with unauthorized sensors or cables which would, alone or in combination with this device, fall within the scope of one or more of the patents relating to this device.

Chapter 11

Monitoring Invasive Pressures (IBP)

The Propaq MD IBP inputs are Type CF defibrillator proof.

This chapter describes how to use the Propaq MD unit to monitor invasive pressures (IBP).

The Propaq MD unit has three invasive pressure channels: P1, P2, and P3. You can use these channels to measure arterial, venous, or intracranial pressures using invasive transducers with 5uV/V/mmHg sensitivity. Each channel requires its own connector, cabling, and pressure transducer.

Invasive Pressure Transducers

The Propaq MD unit is compatible with many types of invasive pressure transducers, including non disposable, disposable dome, and fully disposable transducers. See Appendix B, *Accessories*, for a list of compatible transducers. Do not use light-sensitive disposable transducers.

Use the invasive pressure transducers according to your organization's established clinical protocol and follow the manufacturer's recommendations. Always refer the manufacturer's *Directions for Use* before using a transducer.

- Warning!**
- If electrocautery is used, always avoid using any transducer with a conductive (metal) case connected to its ground shield. Using a conductive transducer case that is connected to its cable shield risks high-frequency burns at the ECG electrodes if the transducer case becomes grounded to earth.
 - Normal alarm functions will detect complete disconnections of invasive pressure transducers; however, the alarm functions will not detect a partial disconnection or the use of some incompatible transducers. Use only approved transducers and ensure that the transducers are connected properly.
 - Before you use the Propaq MD unit on a new patient, always turn it off for at least 2 minutes. This clears the previous patient's trend values, alarm limit settings, and NIBP cuff inflation pressure.
 - Use *only* ZOLL-approved IBP sensors. Use of non-approved sensors may result in inaccurate IBP measurements.
-

IBP Setup

To take safe and accurate IBP measurements using the Propaq MD, you must perform the following steps, each of which corresponds to a section in this chapter. Read each section carefully before you perform IBP measurements.

1. Attach the invasive pressure transducer to the Propaq MD unit.
2. Zero the transducer.
3. Set the invasive pressure alarms (according to your organization's standards).
4. Select a label for the invasive pressure channel.

Attaching the Invasive Pressure Transducer

Follow these steps when attaching the invasive pressure transducer:

1. Inspect the transducer cable. If the cable shows any signs of wear, breakage, or fraying, replace the cable. Replace the transducer dome, if necessary.
2. Apply the transducer according to your organization's procedures. Always refer the manufacturer's Directions for Use before using a transducer.
3. If the transducer is a disposable unit with a separate cable, connect the transducer to the transducer cable.
4. Plug the transducer cable into one of the three six-pin IBP cable connectors on the side of the Propaq MD unit.

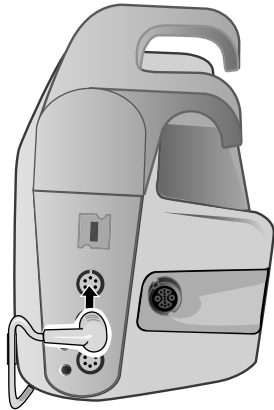


Figure 11-1 Plugging the Transducer into the Propaq MD Unit

When you plug the transducer cable into the unit, the message *ZERO PROBE* appears in the numeric display window for that IBP channel.

Zeroing the Transducer

To ensure that the Propaq MD unit measures pressure accurately, you must zero the transducer before each use. If you change or disconnect a transducer, you must zero the new transducer before use. If you move a transducer to a different monitor, you must zero the transducer again, even if you have already done so on another unit. In addition to the procedure below, follow the transducer manufacturer's *Directions for Use* and your organization's established clinical protocol.

Follow these steps when zeroing a transducer:

1. Place the transducer at the same height as the patient's left atrium.
2. Close the transducer stopcock to the patient.
3. Open the transducer's venting stopcock to atmospheric air.
4. Allow the transducer a few seconds to settle.
5. Use the navigation keys to highlight and select the transducer's IBP channel and display the IBP channel's parameter control panel:

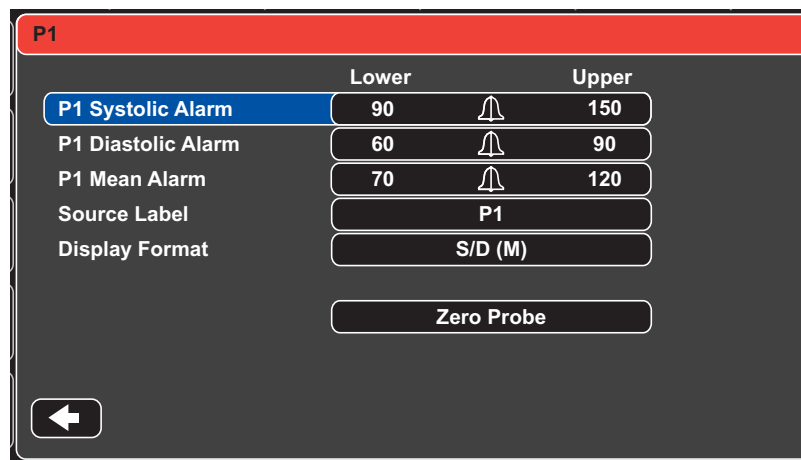


Figure 11-2 IBP Channel Parameter Control Panel

6. Select **Zero Probe**. The unit displays the message *ZEROING* in the IBP Channel's numeric display.
7. The message *ZEROED* appears in the IBP channel's numeric display.
8. Close the transducer's stopcock.
9. If the unit was unable to zero the transducer, the message *ZERO REJECTED* appears in the IBP channel's numeric display. The unit will not display pressure values for the IBP channel until it has successfully zeroed the transducer and established an acceptable zero reference.

Check that the unit is open to atmospheric air and that it is properly connected to the unit, then try zeroing the transducer again. The Propaq MD unit will not zero the transducer if it detects pulsation in the pressure channel, if there is too much noise in the signal, or if transducer's offset is too great.

If you cannot zero the transducer after several attempts, replace the transducer or the transducer cable.

Rezeroing a Transducer

You can re-zero a transducer at any time by opening the transducer stopcock to atmospheric air.

If the unit accepts the new zero reference value, the unit displays pressure values that are based on that value and adjusts the waveform according to the new scale.

Warning! If you attempt to zero an IBP channel after the channel has been successfully zeroed and is currently monitoring a pressure waveform, the unit will display the message, **ZERO REJECTED**, in the IBP channel's numeric window. This message will preempt the display of the valid invasive pressure numerics.

Displaying IBP Measurements

After attaching and zeroing a transducer, the Propaq MD unit displays the invasive pressure's systolic, diastolic, and MEAN values in the IBP channel's numeric display and, optionally (if enabled through the unit's Waveform Select menu) the waveform for that IBP channel:



The Propaq MD unit allows you to specify a label that identifies the channel's IBP measurement, and to select a display format for the numeric display.

The unit displays the waveform scales after you zero the transducer. When the unit accepts the zero reference value, it determines the waveform scales and displays them.

Conditions Affecting IBP Measurements

When reading blood pressure measurements on the IBP numeric display, keep in mind that the following conditions can affect the accuracy of IBP measurements:

- Catheter placement in the vasculature. Artifact such as catheter whip should be handled per your established clinical protocols.
- Position of the transducer stopcock, catheter, and flush port.
- Saline line flushes which will temporarily interrupt accurate pressure measurement.
- Position of the transducer relative to the patient's phlebostatic axis or catheter tip.
- Patient movement.
- Catheter clogging.
- Air bubbles in catheter or transducer dome.

Caution Flush catheter regularly while taking IBP measurements. Always view the IBP waveform to ensure that pressure measurements are based on a physiological waveform.




Enabling/Disabling IBP Alarms and Setting Alarm Limits

When enabled, the Propaq MD unit sounds alarms whenever IBP measurements are outside set limits for the following:

- High and Low Systolic Pressure
- High and Low Diastolic Pressure
- High and Low Mean Arterial Pressure (MEAN)

Note: When enabled, any of the low alarms for IBP (systolic, diastolic, or mean) will also provide an alert in the event of a disconnected catheter.

To enable (or disable) IBP alarms and set Upper and Lower alarm limits and IBP channel, you can either use the navigation buttons to highlight and select the IBP channel display or:

1. Press the **More** quick access key ()
2. Press .
3. Press the **Limits** quick access key ()
4. Use the navigation buttons to highlight and select the appropriate alarm menu selection. For each IBP channel, there are alarm menus for systolic (Systolic Alarm), diastolic (Diastolic Alarm) and mean arterial pressure (Mean Alarm) alarm settings. On the selected Alarm Settings menu, use the navigation keys to select the fields that you want to change. The fields are
 - **Upper Limit Enable**
 - **Lower Limit Enable**
 - **Upper Limit**
 - **Lower Limit**

5. When you are finished changing values on the alarm menu, navigate to the Backarrow key to exit the menu.

Setting Upper and Lower Systolic (SYS) Alarm Limits

Initially, the IBP Systolic Alarm Settings menu specifies that the IBP systolic pressure alarms are enabled (**ON**) or disabled (**OFF**), and displays the default upper and lower systolic limits. The upper and lower limits can be **ON** or **OFF** (default is **OFF**). The following table lists the default IBP Systolic limits for adult, pediatric, and neonate patients, and gives the range in which you can set these limits:

Patient Type	IBP Systolic Limit Default	IBP Systolic Limit Range
Adult	Lower: 75 mmHg Upper: 220 mmHg	Lower: -30 to 298 mmHg Upper: -28 to 300 mmHg
Pediatric	Lower: 75 mmHg Upper: 145 mmHg	Lower: -30 to 298 mmHg Upper: -28 to 300 mmHg
Neonate	Lower: 50 mmHg Upper: 100 mmHg	Lower: -30 to 298 mmHg Upper: -28 to 300 mmHg

Setting Upper and Lower Diastolic (DIA) Alarm Limits

Initially, the IBP Diastolic Alarm Settings menu specifies that the IBP diastolic pressure alarms are enabled (**ON**) or disabled (**OFF**), and displays the default Upper and Lower diastolic limits. The upper and lower limits can be **ON** or **OFF** (default is **OFF**). The following table lists the default diastolic limits for adult, pediatric, and neonate patients, and gives the range in which you can set these limits:

Patient Type	IBP Diastolic Limit Default	IBP Diastolic Limit Range
Adult	Lower: 35 mmHg Upper: 110 mmHg	Lower: -30 to 298 mmHg Upper: -28 to 300 mmHg
Pediatric	Lower: 35 mmHg Upper: 100 mmHg	Lower: -30 to 298 mmHg Upper: -28 to 300 mmHg
Neonate	Lower: 30 mmHg Upper: 70 mmHg	Lower: -30 to 298 mmHg Upper: -28 to 300 mmHg

Setting Upper and Lower Mean Arterial Pressure (MEAN) Alarm Limits

Initially, the IBP MEAN Alarm Settings menu specifies that IBP MEAN alarms are enabled (**ON**) or disabled (**OFF**), and displays the default Upper and Lower MEAN limits. The upper and lower limits can be **ON** or **OFF** (default is **OFF**). The following table lists the default MEAN alarm limits for adult, pediatric, and neonate patients, and gives the range in which you can set these limits:

Patient Type	IBP Mean Limit Default	IBP Mean Limit Range
Adult	Lower: 50 mmHg Upper: 120 mmHg	Lower: -30 to 298 mmHg Upper: -28 to 300 mmHg
Pediatric	Lower: 50 mmHg Upper: 110 mmHg	Lower: -30 to 298 mmHg Upper: -28 to 300 mmHg
Neonate	Lower: 35 mmHg Upper: 80 mmHg	Lower: -30 to 298 mmHg Upper: -28 to 300 mmHg

Setting IBP Source Label

In the IBP channel menu, you can select a label that identifies the source of the channel's IBP measurement. By default, the channels are labeled P1, P2, and P3.

At the Source Label prompt, you can specify that the unit display one of the following labels to identify the IBP channel:

Source Label	Description	Source Label	Description
ABP	Abdominal Aorta Pressure	AO	Aorta
ART	Arterial Pressure	BAP	Brachial Artery Pressure
CVP	Central Venous Pressure	FAP	Femoral Artery Pressure
ICP	Intracranial Pressure	LAP	Labial Artery Pressure
PAP	Pulmonary Artery Pressure	RAP	Radial Artery Pressure
UAP	Umbilical Artery Pressure	UVP	Umbilical Venous Pressure

In the following example, source labels are specified for all three IBP channels:



IBP System Messages

The Propaq MD unit may display the following messages when monitoring IBP:

System Message	Cause
<i>TRANSDUCER FAILURE</i>	The IBP probe is damaged and needs to be replaced.
<i>INCOMPATIBLE TRANSDUCER</i>	The IBP probe is not compatible. See the Appendix B, <i>Accessories</i> , for a list of ZOLL-approved IBP probes.
<i>CHECK PROBE</i>	The IBP probed has become disconnected.
<i>ZERO PROBE</i>	The IBP probe is connected and needs to be zeroed.
<i>ZEROING</i>	The IBP probe is zeroing.
<i>IBP DISABLED</i>	A system error has occurred, and the Propaq MD unit should be serviced.
<i>ZERO REJECTED</i>	The IBP probe was not removed due to a pulsatile pressure signal, excessive IBP artifact or excessive transducer offset.

Chapter 12

Monitoring Temperature

The Propaq MD Temperature inputs are Type CF defibrillator proof.

This chapter describes how to use the Propaq MD unit to monitor temperature.

The Propaq MD unit provides two temperature channels. When both channels are in use, the unit displays each channel's temperature successively, followed by the difference between the temperatures (labeled ΔT).

Temperature Monitoring Setup

To monitor temperature using the Propaq MD unit, perform the following steps:

1. Select the temperature probe and apply it to the patient.
2. Connect the temperature probe to the Propaq MD unit.
3. Configure Temperature alarms and settings (if the current Temperature alarms and settings are not appropriate).

Selecting and Applying Temperature Probes

You should use only temperature probes that are approved for use with the Propaq MD unit. See Appendix B, *Accessories* for a list of ZOLL-approved temperature probes. The use of other probes that do not match the performance specifications of the ZOLL-approved probes may produce incorrect temperature readings.

To apply the temperature probe to the patient, follow your organization's standard procedures. Always refer to probe manufacturer's Directions for Use before using the probe.

- Warning!**
- The application and use of metal-jacketed temperature probes that come in contact with conductive objects or clinical personnel during electrocautery may cause burns at the point of contact between the patient and the temperature probe.
 - To ensure safe and reliable operation including biocompatibility, use only ZOLL-approved temperature probes.
-

Connecting the Temperature Probe

To connect the temperature probe, insert the probe's 1/4" plug into one of the two connection jacks on the side of the Propaq MD unit.



Figure 12-1 Connecting the Temperature Probe to the Propaq MD Unit

Displaying Temperature





When you connect the probe, the unit displays the temperature after a brief pause. The Propaq MD unit displays temperature as a numeric value in the Temperature window. You can specify that the unit display the temperature in ° C or ° F.

Enabling/Disabling Temperature Alarms and Setting Alarm Limits

When enabled, the Propaq MD unit sounds alarms whenever temperature measurements are outside set limits.

You can enable (or disable) temperature alarms and set the upper and lower alarm limits through the Alarms quick access key or the Temp Parameter Control Panel.

To configure temperature alarms through the **Alarms** quick access key:

1. Press the **More** quick access key (.
2. Press .
3. Press the **Limits** quick access key (.
4. Use the navigation keys to highlight and select the **T1 Alarm, T2 Alarm, or ΔT Alarm** menu selection. On the Alarm Settings menu, use the navigation keys to select the fields that you want to change. The fields are
 - **Upper Limit Enable**
 - **Lower Limit Enable**
 - **Upper Limit**
 - **Lower Limit**
5. When you are finished changing values on the alarm menu, navigate to the Backarrow key  to exit the menu.

Setting Upper and Lower Temperature Alarm Limits

Initially, the Temperature Alarm Settings menu specifies that the Temperature alarms are enabled or disabled and displays the default upper and lower limits. The upper and lower limits can be **ON** or **OFF** (default is **OFF**). The following table lists the default Temperature limits for adult, pediatric, and neonate patients, and gives the range in which you can set these limits:

Patient Type	Temperature Limit Default	Temperature Limit Range
Adult	Lower: 35 ° C (95.0 ° F) Upper: 37.8 ° C (100 ° F)	Lower: 0.0 - 48.0 ° C (32.0 - 120.0 ° F) Upper: 2.0 - 50.0 ° C (34.0 - 122.0 ° F)
Pediatric	Lower: 35 ° C (95.0 ° F) Upper: 37.8 ° C (100 ° F)	Lower: 0.0 - 48.0 ° C (32.0 - 120.0 ° F) Upper: 2.0 - 50.0 ° C (34.0 - 122.0 ° F)
Neonate	Lower: 35 ° C (95.0 ° F) Upper: 37.8 ° C (100 ° F)	Lower: 0.0 - 48.0 ° C (32.0 - 120.0 ° F) Upper: 2.0 - 50.0 ° C (34.0 - 122.0 ° F)

Setting Upper and Lower Δ Temperature Alarm Limits

Initially, the Δ Temperature Alarm Settings menu specifies that the Δ Temperature alarms are enabled (**ON**), and displays the default upper and lower limits. The upper and lower limits can be **ON** or **OFF** (default is **OFF**). The following table lists the default Δ Temperature limits for adult, pediatric, and neonate patients, and gives the range in which you can set these limits:

Patient Type	Δ Temperature Limit Default	Δ Temperature Limit Range
Adult	Lower: 0.0° F (0.0° C) Upper: 5.0° F (-15° C)	Lower: 0.0 - 89.8° F (0.0 - 32.1° C) Upper: 0.2 - 90.0° F (-17.7 - 32.2° C)
Pediatric	Lower: 0.0° F (0.0° C) Upper: 5.0° F (-15° C)	Lower: 0.0 - 89.8° F (0.0 - 32.1° C) Upper: 0.2 - 90.0° F (-17.7 - 32.2° C)
Neonate	Lower: 0.0° F (0.0° C) Upper: 5.0° F (-15° C)	Lower: 0.0 - 89.8° F (0.0 - 32.1° C) Upper: 0.2 - 90.0° F (-17.7 - 32.2° C)

Selecting the Temperature Label

Through the Temp Parameter Control Panel, you can configure alarms (as described previously) and select descriptive Temperature channel labels that will appear on the numeric display and on the trend report:

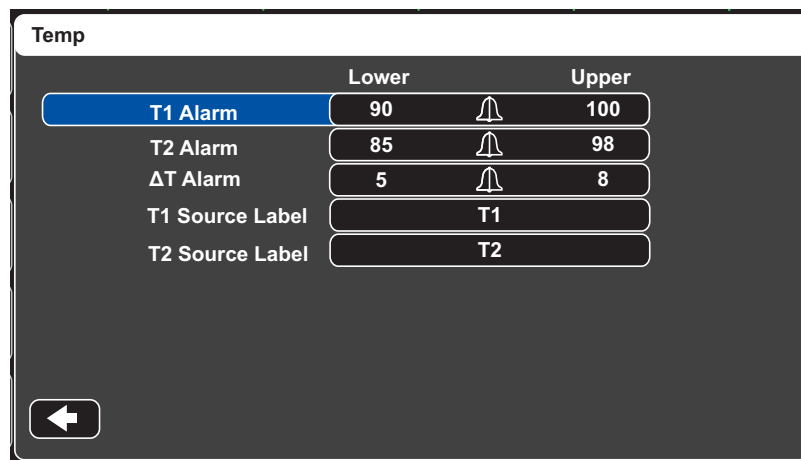


Figure 12-2 Temp Parameter Control Panel

You can select one of the following labels for each temperature channel:

Source Label	Description
ART	Arterial temperature probe
CORE	Central body temperature or tympanic membrane temperature probe
ESOPH	Esophageal temperature probe
RECT	Rectal temperature probe
SKIN	Skin temperature probe (surface application)
VEN	Ventilator airway temperature probe
NASO	Nasopharynx or nasal/oral temperature probe

If you don't select a label, the Temperature channels appear with the default labels of T1 and T2.

Temperature System Messages

The Propaq MD unit may display the following messages when monitoring Temperature.

Note: The temperature function performs a self test when initially powered on and also performs system tests automatically, every 10 seconds, while this function is active.

System Message	Cause
<i>CHECK PROBE</i>	The temperature probe is disconnected. Check probe and reconnect it.
<i>PROBE FAILURE</i>	The temperature probe is defective. Replace the Temperature probe.
<i>TEMP DISABLED</i>	A system error has occurred. The Propaq MD unit cannot take temperature measurements and should be serviced.

Chapter 13

Automated External Defibrillator (AED)



ZOLL hands-free therapy electrodes are a defibrillation-protected Type BF patient connection.

Warning! Use only pediatric electrodes to defibrillate patients under 8 years of age in AED mode, and make sure the patient mode is set to pediatric. Use of adult electrodes or adult mode with pediatric patients can result in the delivery of excessive energy doses.

The AutoPulse Plus is only intended for use on adults 18 years of age or older.

This chapter describes the recommended method of operation in AED Mode. The Propaq MD unit is configured to operate in compliance with the American Heart Association and European Resuscitation Council Guidelines for Adult Basic Life Support and Use of Automated External Defibrillators.^{1,2,3,4} If your local protocol requires a different procedure, follow that protocol.

The AED Mode is Supervisor configurable, and when the unit is configured to start up in AED Mode, it powers up in the Analysis/CPR Protocol, and guides you through a cardiac event by performing ECG analysis, preparing the device for a shock (if needed), and leading you through a CPR interval.

This chapter also describes how to switch the AED unit to Manual mode (see “Switching to Manual Mode Operation” on page 14-10).

-
1. *Circulation*, 2005; 112; IU-19 — IU-34
 2. *Resuscitation (2005)*; 671S, S7-S23
 3. *Circulation 2010*; 122; S640-S656
 4. *Resuscitation (2010)*; 1219-1276

In AED operation, there is an Analysis/CPR Protocol mode guides you through a cardiac event by performing ECG analysis, preparing the device for a shock (if needed), and leading you through a CPR interval. This cycle is repeated as long as Analysis/CPR Protocol is active and pads are attached to the patient. If pads become detached from the patient or shorted during the Analysis/CPR Protocol, the protocol halts and waits for the pads to be reattached or continues through the CPR interval and then halts and waits for the pads to be reattached.

The Propaq MD defibrillator is capable of analyzing a patient's ECG rhythm in two different ways. The first mode of analyzing is automatic; the other mode of analyzing is user activated analysis and is initiated by pressing the **Analyze** quick access key.

Automatic and user activated analysis of a patient's ECG can be performed only when:

- Hands-free therapy electrodes are connected, and making good contact with the patient.
- The defibrillator is on.

The analysis determines if there is a shockable rhythm and if a shockable rhythm is present prompts the operator to shock the patient at the preconfigured energy level. If the analysis does not detect a shockable rhythm, the unit alerts the operator that no shock is advised.

If the first two segments are in agreement with each other, the final shock or no shock rhythm decision is made and a third segment is not processed.

If the **Shock** button is pressed and a shock is successfully delivered, the shock count increments by one and is displayed on the screen.

AED Operation

Determine Patient Condition Following Medical Protocols

Verify:

- Unconsciousness.
- Absence of breathing.
- Absence of pulse.

Begin CPR Following Medical Protocols

Request additional assistance.

Prepare Patient

Remove all clothing covering the patient's chest. Dry chest if necessary. If the patient has excessive chest hair, clip or shave it to ensure proper adhesion of the electrodes.

Attach hands-free therapy electrodes according to instructions on the electrode packaging.

Ensure that the electrodes are making good contact with the patient's skin and are not covering any part of the ECG electrodes.

Connect the hands-free therapy electrodes to the multi-function cable (MFC or OneStep) if not already connected.

The message *ATTACH PADS* or *CHECK PADS* will be displayed and energy will not be delivered if the therapy electrodes are not making good contact with the patient. The message *SHORT DETECTED* is displayed if a short circuit exists between the therapy electrodes.

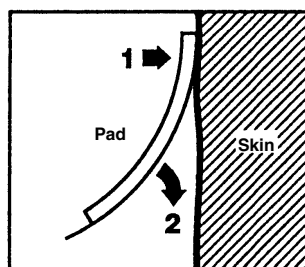
Note: Since analysis is only done using Pads as a lead, even if an ECG cable is connected and Lead II is available, the unit still displays a *CHECK PADS* message.

When the Propaq MD is connected to the AutoPulse Plus the text APLS appears next to first waveform trace on the Propaq MD display in place of Pads. If APLS does not appear on the Propaq MD display, check that the Propaq MD and AutoPulse Plus are properly connected. If APLS still does not appear, or a PADDLE FAULT occurs, discharge energy internally by changing the energy selection, disconnect the Multi-Function Cable and electrodes from the AutoPulse Plus, and connect the Multi-Function Cable directly to the electrodes.

Therapy Electrode Application

Warning! Poor adherence and/or air under the therapy electrodes can lead to the possibility of arcing and skin burns.

1. Apply one edge of the pad securely to the patient.
2. Roll the pad smoothly from the applied edge to the other, being careful not to trap any air pockets between the gel and skin.

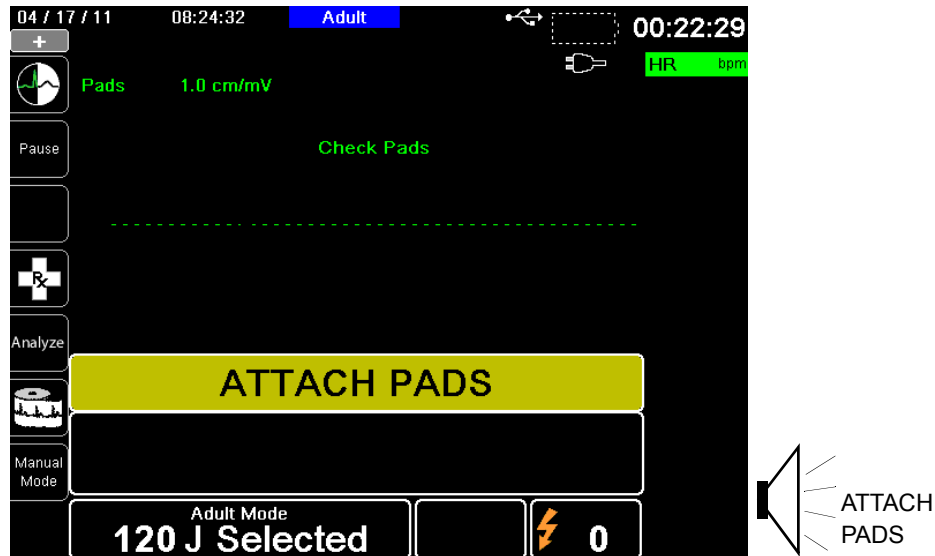


Note: If it is not possible to place the "BACK" pad on the patient's back, the pads should be placed in the standard apex-sternum positions. Effective defibrillation will result, but pacing will usually be less effective.

1 Turn on unit

Press the green power switch located on the top of the unit. The green, yellow, and red lights on the top of the unit flash on and off, and then displays the message *SELF TEST PASSED*.

If no hands-free therapy electrodes have been attached to the patient and connected to the Propaq MD unit, the *ATTACH PADS* message and voice prompt will be issued.



Select Energy

The default energy selections for adult patients are:

Shock 1 - 120 joules

Shock 2 - 150 joules

Shock 3 - 200 joules

The default energy selections for pediatric patients are:

Shock 1 - 50 joules

Shock 2 - 70 joules

Shock 3 - 85 joules

Note: Pediatric defibrillator energy levels should be selected based on site specific protocols.

Note: If the Propaq MD unit has been configured to begin CPR upon start up, it will automatically begin with the CPR interval.

2 Analyze

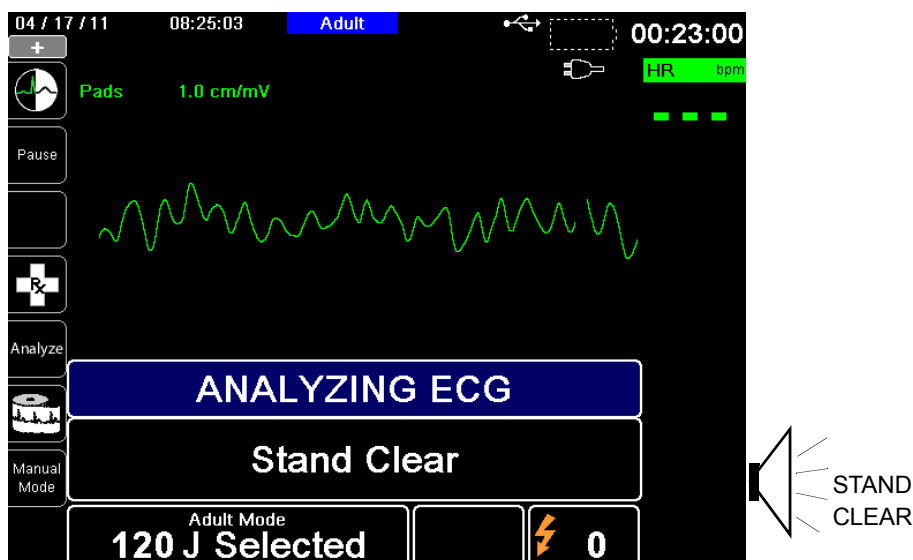
Warning! Do not analyze the patient ECG during patient movement. A patient must be motionless during ECG analysis. Do not touch the patient during analysis. Cease all movement via stretcher or vehicle before analyzing the ECG.

When using the AutoPulse Plus, stop compressions prior to performing ECG analysis. Compressions may be resumed following the analysis.

The Propaq MD automatically begins the analysis of the patient's ECG rhythm, displays an ANALYZING ECG message for 5 seconds, and announces and displays a *STAND CLEAR* message. If therapy electrodes have not been properly connected to the patient, an *ATTACH PADS* or *CHECK PADS* message is displayed and analysis will be inhibited.

Note: You can press **Pause** to temporarily stop the rescue cycle. While the rescue cycle is paused, ECG analysis continues in the background. The trends, log, alarm monitoring, and 12-lead features are only accessible when the rescue cycle is paused. Press the **Analyze** quick access key to resume the analysis process.

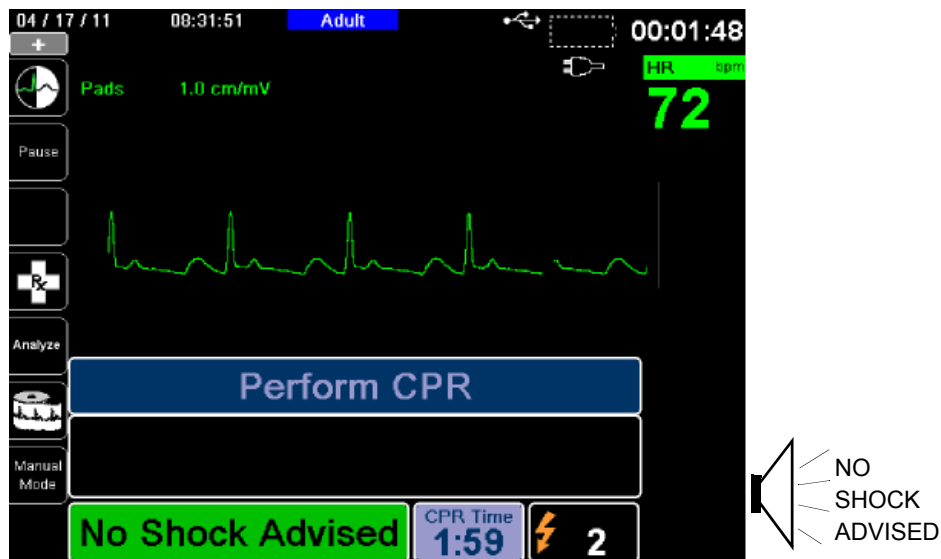
Note: If the Propaq MD has been configured to perform extra CPR at startup, it displays a *CHECK PULSE* voice prompt and the message appears for 10 seconds. Then it displays a *PERFORM CPR* message along with a voice prompt for the configured duration before analysis begins. You can start an ECG analysis during the CPR interval by pressing **Analyze**.



An ANALYZING ECG message is displayed while the patient's ECG is analyzed. Once the analysis is completed, the unit indicates whether or not a shock is advised.

Warning! ECG rhythm analysis does not warn of patient asystole, which is not a shockable rhythm.

When a nonshockable rhythm is detected, the unit displays a *NO SHOCK ADVISED* message. Immediately begin chest compressions and continue other treatment per protocol.



If the patient’s rhythm is shockable, the unit displays the *SHOCK ADVISED* and *PRESS SHOCK* messages. The defibrillator automatically prompts the operator to shock the patient at the preconfigured energy level and the **SHOCK** button illuminates.

A continuous tone sounds for 20 or 50 seconds (depending on configuration), followed by a higher pitch tone for 10 seconds. You must deliver the shock within this 30 or 60 second interval (depending on configuration), or the defibrillator will disarm itself.



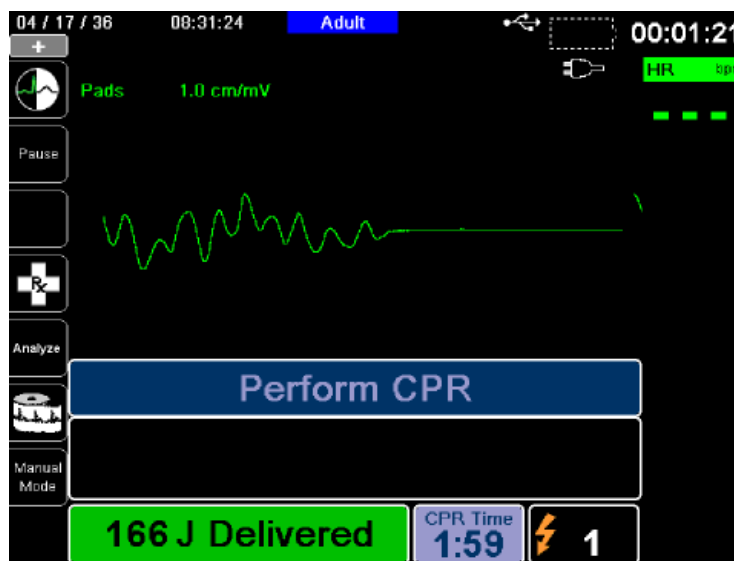
3 Press SHOCK

Warning! Warn all persons in attendance of the patient to **STAND CLEAR** prior to defibrillator discharge.
Do not touch the bed, patient, or any equipment connected to the patient during defibrillation. A severe shock can result. Do not allow exposed portions of the patient's body to come in contact with metal objects, such as a bed frame, as unwanted pathways for defibrillation current may result.

Press and hold the illuminated **SHOCK** button on the front panel until energy is delivered to the patient.

Observe the patient or ECG response to verify that the shock has been delivered.

The delivered energy level and the shock number (1) are displayed in the panel at the bottom of the screen.



Perform CPR

Begin chest compressions and rescue breathing per local protocol as prompted by the unit.

Note: If ZOLL OneStep CPR pads, OneStep Complete pads or CPR-D-padz are connected, the unit monitors the rate and depth of chest compressions and can display *PUSH HARDER* and *GOOD COMPRESSIONS* messages and voice prompts.

Repeat Analysis

After performing CPR for the configured period of CPR, the unit will restart ECG analysis automatically.

Note: Reanalysis of the ECG rhythm is inhibited for 3 seconds after a shock.

Stop CPR

After performing CPR for the configured period of CPR, the unit will issue a *STOP CPR* prompt while it restarts ECG analysis.

Continue Patient Care

Continue patient care according to medical protocols.

ExpressShock

The ExpressShock™ analysis algorithm provides ultrafast shock/no-shock decision. It reduces total pause time to as little as 3 seconds. ExpressShock is available in AED mode only or in both AED and Rescue Protocol modes of operation. For further information and how to enable/disable this feature, consult the *Propaq MD Configuration Manual*.

Note: ExpressShock is only available in Adult mode and when one of the following electrodes is used: ZOLL OneStep CPR electrodes, OneStep Complete electrodes, or CPR-D-padz.

WARNING! Performance of the ExpressShock mode has not been demonstrated in patients under 8 years of age or less than 55 lbs (25 kg).

The Shock Conversion Estimator

Shock Conversion Estimator takes the output of the analysis algorithm and performs additional analysis to estimate the probability of whether or not the current ECG can successfully be converted by electrical therapy. If the probability of a successful shock is low, the system will advise against a shock and instead instruct to continue CPR as this may be more beneficial to victim resuscitation efforts.

For more information on enabling/disabling the Shock Conversion Estimator feature, please refer to the *Propaq MD Configuration Manual*.

WARNING! Performance of the Shock Conversion Estimator has not been demonstrated in patients under 8 years of age or less than 55 lbs (25 kg).

Operating Messages

The unit uses both audio and visual prompts to present critical information to operators. The following information describes the unit default configuration. If your device has been custom configured, some of the information may be different.

There are 10 voice prompts used in AED mode. Most of these prompts are accompanied by a message displayed on the monitor. The voice prompts are given only once, but the monitor continues to display the message until new action is taken by the operator or the device status changes.

The unit will alternately display two different messages in the same field of the display when two conditions are detected at the same time. For example, a *LOW BATTERY* message may alternately display on the same line of the monitor as the *CHECK PADS* message.

Audio and Display Messages

The display messages and voice prompts that can occur during AED operation are described below.

ATTACH PADS

If the unit is powered on without therapy pads connected to the patient, the *ATTACH PADS* message is announced and displayed.

ANALYZING ECG/STAND CLEAR

The *ANALYZING ECG* message is displayed and the *STAND CLEAR* message is displayed and announced when the ECG analysis starts automatically or after pressing the **Analyze** quick access key. They indicate that an active ECG analysis is in progress.

SHOCK ADVISED

A shockable rhythm has been detected and defibrillation is advised. The selected energy level is displayed.

PRESS SHOCK

This message is displayed and announced when the ECG analysis has determined that a shock is advised and the selected energy is ready to be delivered.

SHOCKS: XX

This message displays the number of shocks that have been delivered by the unit since it was powered on. It resets to 0 after the unit has been off for more than two minutes.

NO SHOCK ADVISED

When ECG analysis detects a nonshockable rhythm, this message is announced and displays for 10 seconds following completion of the analysis.

CHECK PULSE

If configured to do so, this message is displayed and announced in the following situations:

- After a No Shock Advised analysis result
- During the CPR interval after a No Shock Advised analysis result
- After the final shock is delivered

IF NO PULSE, PERFORM CPR

If configured to do so, this message is displayed and announced in the following situations:

- During the CPR interval after a No Shock Advised analysis result
- During the start of extra CPR interval

PERFORM CPR

If configured to do so, this message is displayed and announced during the CPR interval after a No Shock Advised analysis result.

STOP CPR

After performing CPR for the configured period, the unit will issue a *STOP CPR* prompt while it restarts ECG analysis.

PUSH HARDER

This message is announced when the chest compressions applied during CPR are not deep enough.

GOOD COMPRESSIONS

This message is announced when the chest compressions applied during CPR are deep enough.

CHECK PADS

This message is displayed and announced when the therapy pads have been disconnected from the patient.

CHECK PATIENT

This message is displayed and announced when the unit is paused and detects a shockable rhythm during continuous background ECG analysis. The prompt persists as long as a shockable rhythm is being detected. Press the **Analyze** quick access key to resume ECG analysis.

Switching to Manual Mode Operation

Press the **Manual Mode** quick access key on the front panel of the unit to enter the Manual mode of operation.

Using the navigation keys, select the four digits in the Manual Mode pass code. Press **SAVE** when you are finished. Once you have entered your pass code, you will be able to enter Manual mode.

Note: If the unit has not been configured to enter a pass code, the message *Exit to Manual Mode* is displayed. Use the navigation keys to select **Yes** to enter the Manual mode of operation. If you do not press **Yes** within 10 seconds, the unit will revert back to AED operation.

When changing from AED mode to Manual mode, the current selected energy level is maintained.

Note: To transfer back to AED mode from Manual mode, power down the unit for more than 30 seconds and less than two minutes, then power it back up. If you wait longer than two minutes, the unit will reset the settings to the defaults and treat the case as a new patient.

Chapter 14

12-Lead ECG Interpretive Analysis



The Propaq MD 12-Lead input is Type CF defibrillator proof.

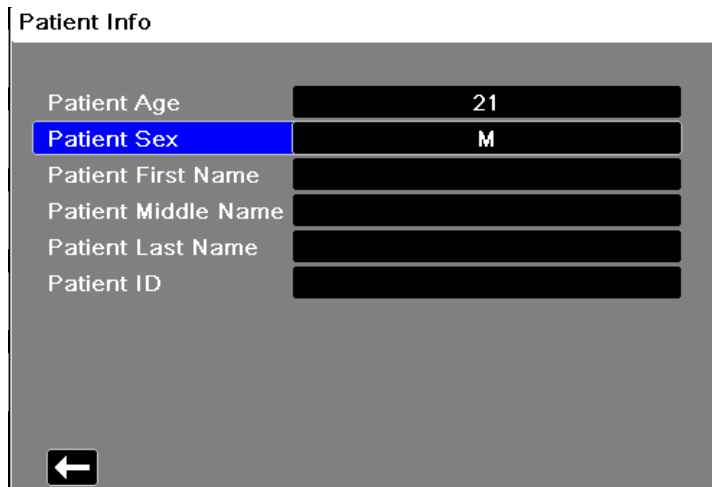
This chapter describes how to use the Propaq MD unit to monitor 12-Lead ECG for adult and pediatric patients, and how to display 12-Lead ECG Interpretive Analysis information for adult patients.

Propaq MD 12-Lead ECG Monitoring provides simultaneous acquisition and storage of 12-Lead information for adult and pediatric patients, and post-acquisition Interpretive Analysis for adult patients.

- Warning!**
- 12-Lead ECG monitoring is intended for the recording of 12-lead ECG signals from adult and pediatric patients in the supine, resting position -- always ensure that the patient is kept motionless during 12-lead ECG signal acquisition and analysis. Use of the device to acquire ECG signals from moving or shaking patients may produce noisy signals that are difficult to interpret.
 - The 12-Lead Interpretive algorithm's interpretive statements are designed to enhance the diagnostic process. They are no substitute for the qualified judgment of a properly trained clinician. As with any diagnostic test, always give consideration to patient symptoms, history, and other relevant factors.
 - 12-Lead Interpretive Analysis is for use with *only* adult patients.
 - It is important to enter each patient's age and gender prior to performing ECG analysis using the Inovise 12L Interpretive Algorithm. Providing patient age and gender will ensure that highest accuracy of ECG analysis is attained. If age is not provided, a default of 45 years is used. If gender is not provided, the default is male.
 - Excessive body hair or wet, sweaty skin may interfere with electrode adhesion. Remove the hair and/or moisture from the area where the electrode is to be attached.
 - Remove ECG electrodes from their sealed package immediately prior to use. Using previously opened or out-of- date electrodes may degrade the ECG signal quality.
 - Monitoring electrodes may become polarized during defibrillator discharge, causing the ECG waveform to briefly go off screen. ZOLL Medical Corporation recommends the use of high quality silver/silver chloride (Ag/AgCl) electrodes to minimize this effect; the circuitry in the instrument returns the trace to the monitor display within a few seconds.
 - Wait 15 seconds after defibrillator discharge before attempting a 12-lead acquisition. Electrode polarization subsequent to defibrillator discharge may result in excessive noise on the 12-lead ECG printout.
 - When not in use, cover the patient cable's V-lead connector with the supplied plastic cap. Failure to do so may result in a shock hazard during defibrillation attempts.
 - To assure protection against the effects of defibrillator discharge, use only 12-lead cables supplied by ZOLL Medical Corporation.
 - Check the operation and integrity of the Propaq MD unit and 12-lead cable regularly by performing the Daily Operational Verification Test.
 - When attempting to interpret subtle ECG changes (such as ST segments) use only the Diagnostic frequency response setting. Other frequency response settings may cause misinterpretation of the patient's ECG.
 - Use only ZOLL-approved accessories to ensure the Type CF defibrillator proof rating of the 12-Lead input.
 - Implanted pacemakers may cause the heart rate meter to count the pacemaker rate during incidents of cardiac arrest or other arrhythmias. Carefully observe pacemaker patients. Check the patient's pulse; do not rely solely on heart rate meters. Dedicated pacemaker detection circuitry may not detect all implanted pacemaker spikes. Patient history and physical exam are important in determining the presence of an implanted pacemaker.

Entering Patient Information

To enter patient information, press the **12-Lead** quick access key () , then the Patient Info quick access key (). The screen displays the Patient Info parameter panel, in which you can enter the patient's name, age, gender, and identification number: The screen displays the Patient Info parameter panel, in which you can enter the patient's name, age, gender, and identification number:



Patient Info	
Patient Age	21
Patient Sex	M
Patient First Name	
Patient Middle Name	
Patient Last Name	
Patient ID	

Figure 14-1 Patient Info Control Panel

The Propaq MD unit uses the name that you enter in the Patient Info panel to label the 12-lead ECG monitoring snapshots that it saves.

To enter patient information, use the navigation keys to highlight and select a parameter on the Patient Info panel, then press the **Select** key.



Entering the Patient Name and ID

When you select the **Patient Last Name** field (or the Patient First/Middle Name, ID, or Physician fields), the screen displays an information entry panel:



To enter a character into the parameter, highlight the character, then press **Select**. The screen displays the selected character in the area below the parameter name.

To navigate through the information entry panel, use the following keys:

- Use the Row Up quick access key () to move to the previous row on the panel.
- Use the Row Down quick access key () to move down one row on the panel.

Use the navigation keys on the front panel to highlight the next or previous character on the information entry panel.

You can also select the following function keys on the information entry panel:

- **Backspace** Erases the last character entered.
- **Clear** Erases all characters entered.
- **SAVE** Saves the characters entered for that parameter and returns you to the Patient Info panel.
- **Cancel** Returns you to the Patient Info panel without saving the characters entered.

Entering Patient Age and Gender

The Patient Info parameter panel provides default values for the Patient Age and Patient Gender parameters. To change a default value, highlight and select the parameter, and then specify a new value as follows:

To change Patient Age, use the navigation keys on the front panel to decrease or increase the default value (45), then press **Select**.

To change Patient Gender, use the navigation keys on the front panel to toggle between the default value, M (male), and F (female), then press **Select**.

Note: It is important that you provide the patient's age and gender prior to performing ECG analysis using the Inovise 12L Interpretive Algorithm. Entering the correct age and gender ensures that the highest degree of ECG analysis is obtained. If you do not enter the patient's age or gender the Propaq MD uses the default age (45 years) and default gender (male). See "12-Lead Interpretive Analysis" on page 14-9.

12-Lead ECG Monitoring Setup

The proper application and placement of electrodes is essential for high quality 12-Lead ECG monitoring. Good contact between the electrode and skin minimizes motion artifact and signal interference.

To set up 12-lead ECG monitoring, perform the following steps:

1. Prepare the patient's skin for electrode application.
2. Apply the electrodes to the patient.
3. Connect each lead of the ECG cable to the appropriate electrode.
4. Connect the 12-Lead cable to the Propaq MD unit.
5. Observe the patient's electrocardiogram on the display, and adjust size of the 12-Lead ECG waveform traces, as necessary.

Preparing the Patient for Electrode Application

The proper application of electrodes is essential for high quality ECG monitoring. Good contact between the electrode and skin minimizes motion artifact and signal interference.

Before applying electrodes, prepare the patient's skin, as necessary:

- Shave or clip excess hair at electrode site.
- Clean oily skin with an alcohol pad.
- Rub site briskly to dry.

Applying Electrodes to the Patient

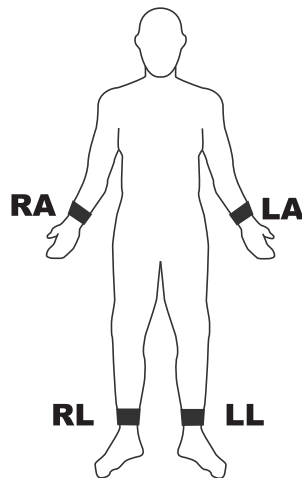
Depending on local usage, ECG lead wires are marked with certain labels. Refer to the following table for labels and color codes for the different lead sets

Location	AHA ¹ Labels	IEC ² Labels
Right Arm	RA (white)	R (red)
Left Arm	LA (black)	L (yellow)
Right Leg	RL (green)	N (black)
Left Leg	LL (red)	F (green)
Chest	V1	C1
Chest	V2	C2
Chest	V3	C3
Chest	V4	C4
Chest	V5	C5
Chest	V6	C6

¹ American Heart Association

² International Electrotechnical Commission

Patients should be in a resting, supine position when performing 12-Lead ECG monitoring. ZOLL Medical Corporation recommends placing the limb electrodes anywhere along the ankles and wrists.



Avoid placing electrodes over tendons and major muscle masses.

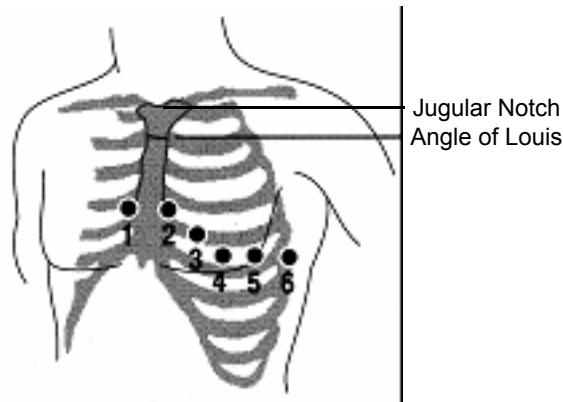
Make sure that the ECG electrodes are placed to allow defibrillation, if necessary.

Place the precordial electrodes across the chest in the following locations:

Electrode	Placement
V1/C1	Fourth intercostal space, at the patient's right sternal margin.
V2/C2	Fourth intercostal space, at the patient's left sternal margin.
V3/C3	Midway between V2/C2 and V4/C4.
V4/C4	Fifth intercostal space, on the patient's midclavicular line.
V5/C5	Patient's left anterior axillary line, at the horizontal level of V4.
V6/C6	Patient's left midaxillary line, at the same horizontal level as V4 and V5.

Locating the V1/C1 position (fourth intercostal space) is critically important because it is the reference point for locating the placement of the remaining V-leads. To locate the V1/C1 position:

1. Place your finger on top of the jugular notch (see figure below).
2. Move your finger slowly downward about 1.5 inches (3.8 centimeters) until you feel a slight horizontal ridge or elevation. This is the "Angle of Louis," where the manubrium joins the body of the sternum.



3. Locate the second intercostal space on the patient's right side, lateral to and just below the "Angle of Louis."
4. Move your finger down two more intercostal spaces to the fourth intercostal space which is the V1 position.

Note: When placing electrodes on female patients, always place leads V3-V6 under the breast rather than on the breast.

Connecting the 12-Lead Cable

Connect the 12-Lead ECG cable to the ECG input connector on the left side of the unit as follows:

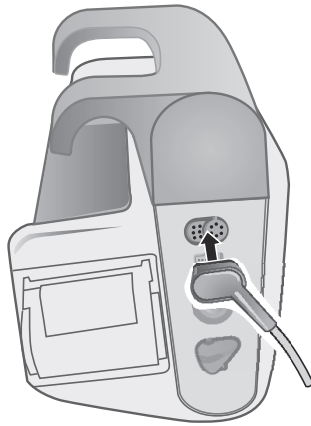
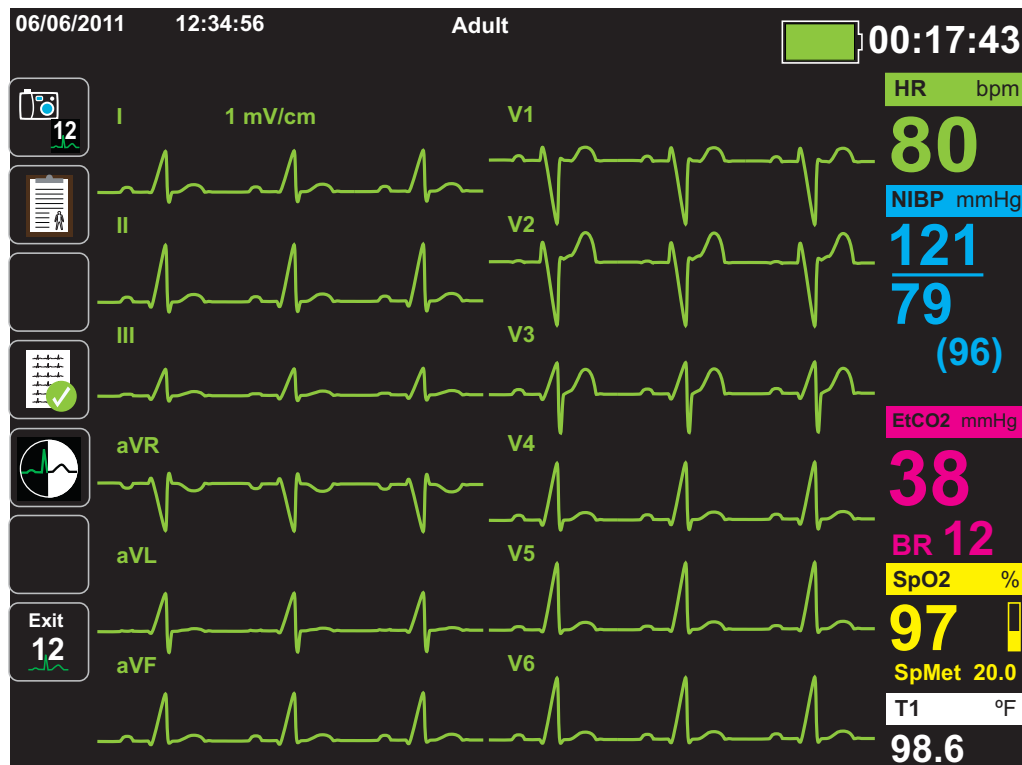


Figure 14-2 Connecting the 12-Lead ECG Cable

Observing the 12-Lead Waveform Traces

To observe the 12-Lead waveform traces, press **12**. The screen displays all twelve waveform traces, with the size displayed above the waveform traces:




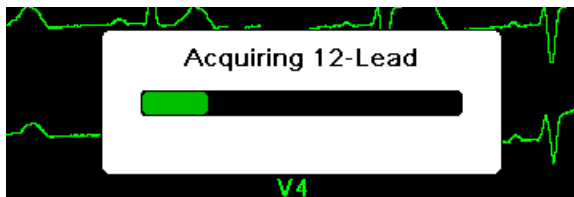
Note: Real-time waveform traces are delayed by 1 second.

12-Lead Interpretive Analysis

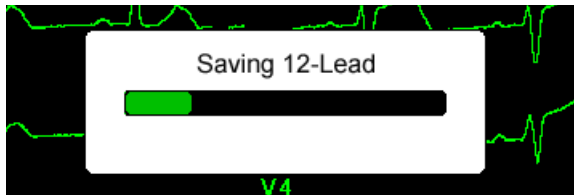
After observing the patient's ECG and determining that all 12-lead traces display correctly, you can initiate 12-Lead Interpretive Analysis (12-Lead Interpretive Analysis *must* be enabled through the Supervisor Menu).

Note: 12-Lead Interpretive Analysis is for Adult patients only. It is important that you provide the patient's age and gender prior to performing ECG analysis using the Inovise 12L Interpretive Algorithm. Entering the correct age and gender ensures that the highest degree of ECG analysis is obtained. If you do not enter the patient's age or gender the Propaq MD uses the default age (45 years) and default gender (male). See "Entering Patient Information" on page 14-3.

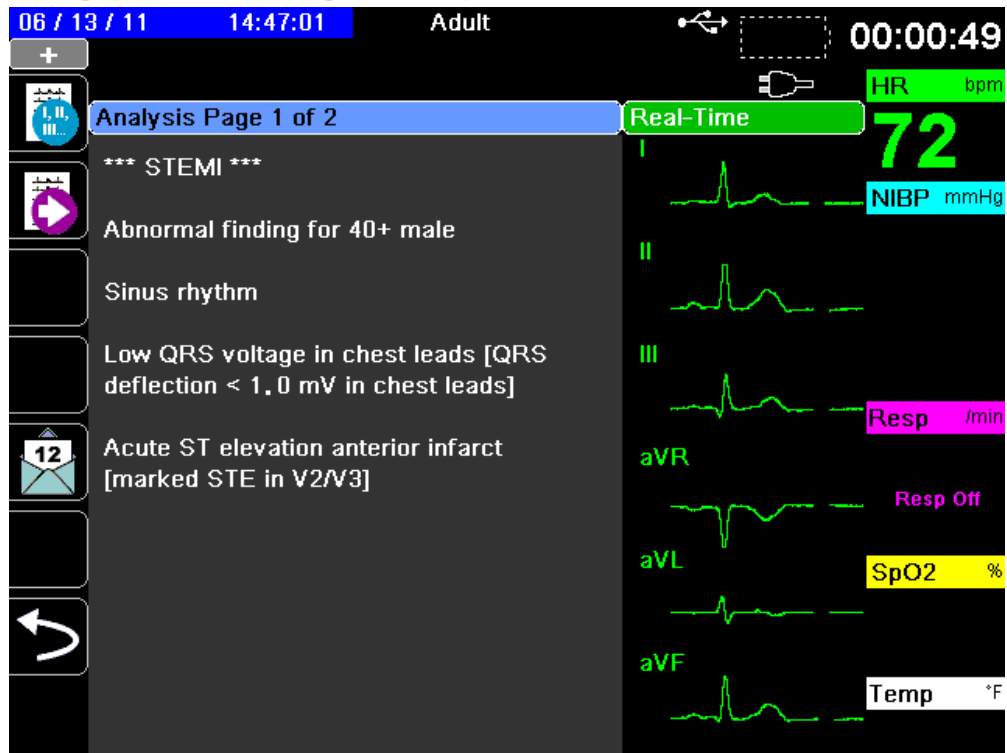
To begin 12-Lead Interpretive Analysis, press the **Acquire** quick access key (). If the Patient Info panel displays provide the patient's information by using the navigation keys to highlight and select a parameter on the Patient Info panel, then press the **Select** key (see "Entering Patient Information" on page 14-3). The Propaq MD unit displays the *Acquiring 12-Lead* Status bar as it collects 10 seconds of 12-Lead ECG data:




After acquiring the ECG data, the unit saves the data and displays the *Saving 12-Lead* Status Bar in the following manner:



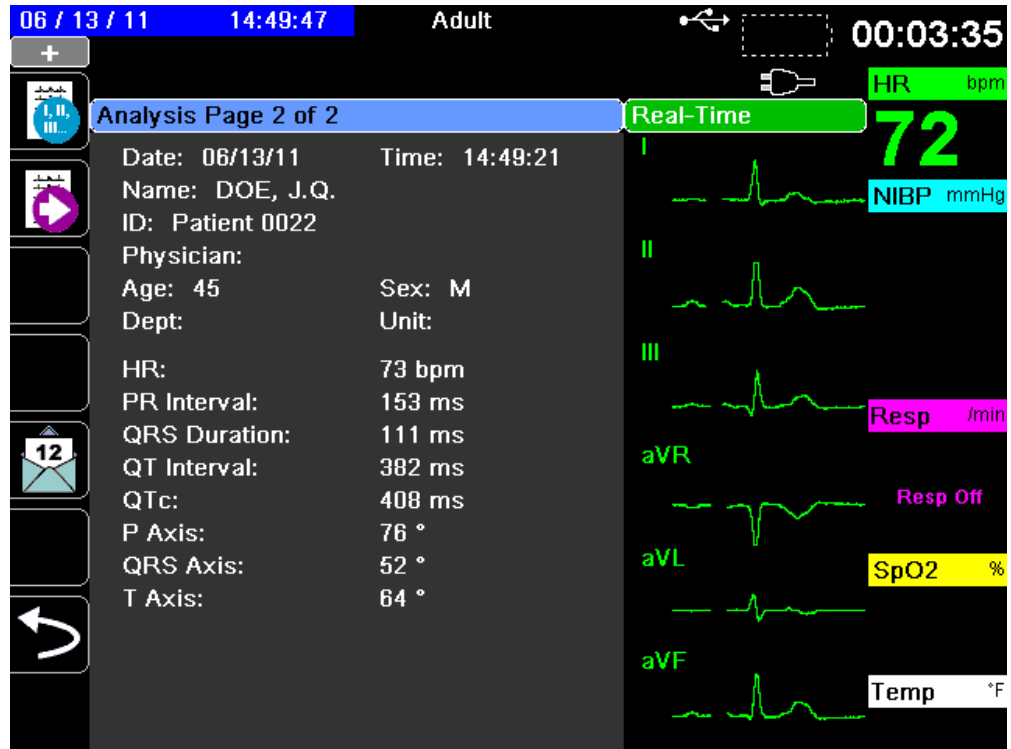
After saving the data, the unit performs the post-acquisition Interpretive Analysis and displays the first page of 12-Lead Interpretive Analysis information:




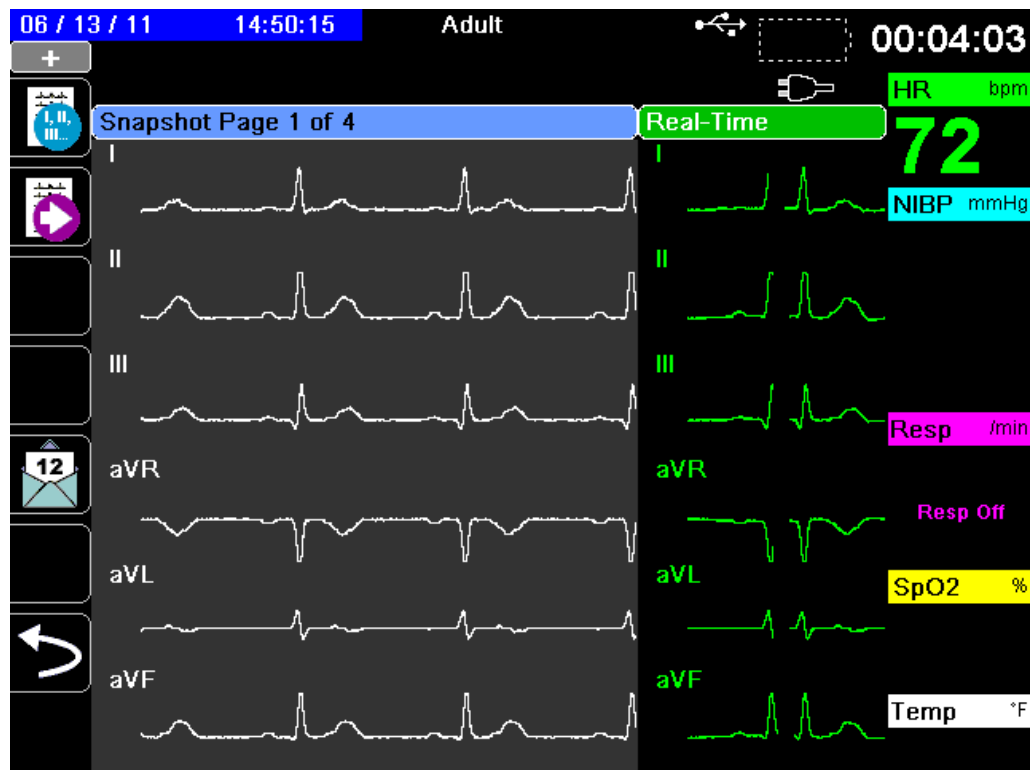
In the example above, the interpretive statement, *****STEMI*****, indicates the occurrence of ST-Elevation Myocardial Infarction. The interpretive statements that the Propaq MD unit displays are produced by the Audicor software of Inovise Medical, Inc. For more information on these interpretive statements, see the *Inovise 12L Interpretive Algorithm Physician's Guide*.

To display *Analysis Page 2*, press the **12-Lead Review Next** quick access key ().

Analysis Page 2 displays the identifying information that has been entered for the patient and additional analysis statements:



You can then view four 12-Lead snapshot pages by pressing  to step through them sequentially. For example, the unit displays the following 12-Lead snapshot after the *Analysis Page 2*:




Fault Conditions Affecting 12-Lead Interpretive Analysis

The Propaq MD unit will not perform Interpretive Analysis if it detects one of the following fault conditions when attempting to acquire 12-Lead data:


- A pacer signal is present.
- A lead fault is detected in the ECG cable.
- An invalid cable is in use.


If the Propaq MD unit detects one of these fault conditions, *Analysis Page 1* indicates that there is *No data available* for Interpretive Analysis and lists the fault condition; all measurements on *Analysis Page 2* appear as *N/A*.

Once you have corrected the fault condition, press  to confirm the correction and perform the 12-Lead Interpretive Analysis.

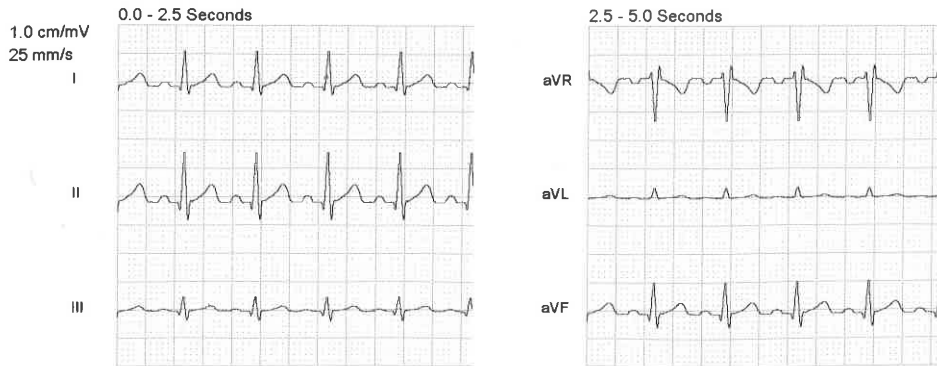
Printing 12-Lead Waveform Traces

Once you have determined that the Propaq MD unit is correctly setup for 12-Lead ECG monitoring, you can print the 12-Lead ECG traces for review and analysis.

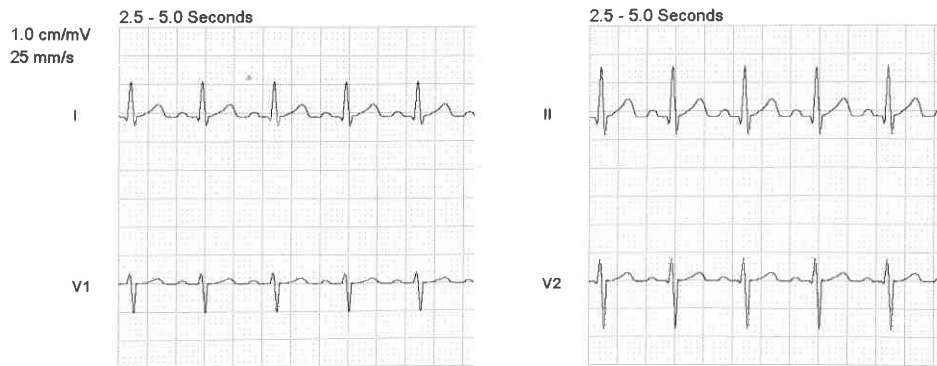
Press  to collect 10 seconds of 12-Lead data for print.

Press the **Print** quick access key () to print a 12-lead snapshot, which begins with a header that gives the date, time, and patient information, followed by 2.5 second samples of all twelve waveform traces. The waveform traces print in either:

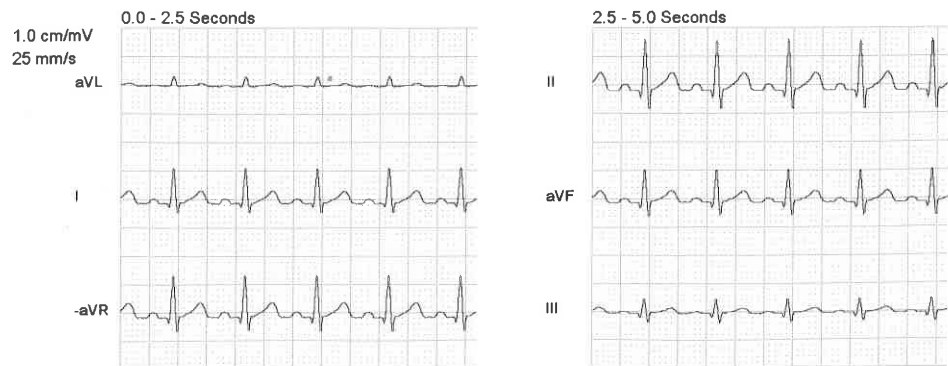
a 3 x 4 format (the default).



or a 2 x 6 format:



or a 3 x 4 Cabrera format:





or 3 x 4 Non -Staggered



or 3 x 4 Cabrera Non-Staggered




The Propaq MD unit stores a minimum of 32 12-Lead snapshots in a separate log. Once 32 12-lead snapshots are stored, the oldest snapshot in the log is overwritten by subsequent snapshots. Note that if a patient data log is full, you will not be able to store 12-lead snapshots. The 12-lead snapshots are erased when you clear the log.

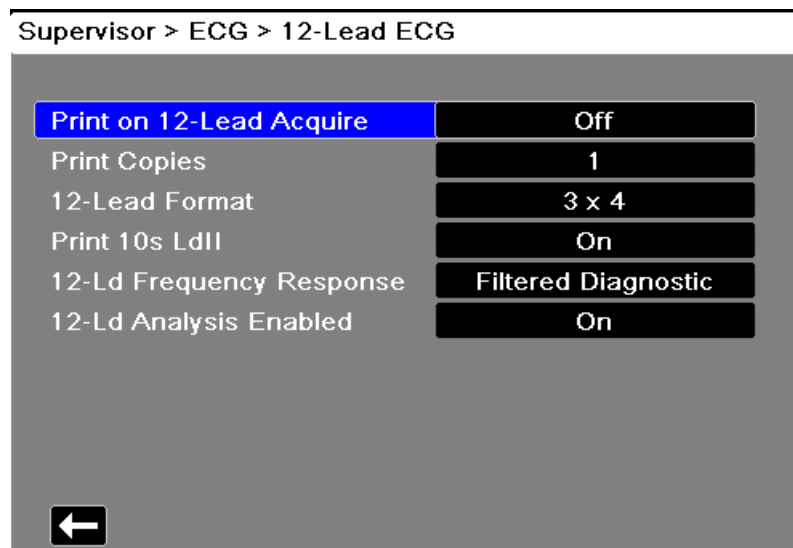
When you are done viewing and printing the 12-Lead waveform traces, press the **Exit 12** quick access key () or the **Home/Display** button () to restore the display of other monitoring functions.

12-Lead Print and Display Options


The Propaq MD unit provides additional 12-Lead print and display options that you can specify through the Supervisor parameter control panels (access to Supervisor is passcode-controlled).

Press the **Setup** quick access key () , then select Supervisor. Using the navigation keys, select the four digits in the Supervisor passcode. Press **SAVE** when you are finished. Once you have entered your supervisor passcode, you will be able to access the configurable options in the Supervisor menu.


Select the Supervisor> ECG> 12-Lead option to display the 12-Lead parameter control panel:



Selecting 12-Lead Acquire

When enabled, the unit automatically prints the 12-Lead report when you press  . By default, this feature is not enabled.

Specifying the Number of 12-Lead Print Copies

This option allows you to specify that the Propaq MD unit print up to five copies of the 12-lead waveform trace set after pressing  . By default, the unit prints only one 12-lead snapshot.

Specifying the 12-Lead Print Format

This option allows you to specify the print format for the 12-lead waveform traces: 3 x 4 (default), 2 x 6, or 3 x 4 Cabrera, 3 x 4 Non-Staggered, 3 x 4 Cabrera Non-Staggered.format.

Printing 10 Seconds of the Lead II Waveform Trace

This option allows you to specify that the unit print 10 seconds of the Lead II waveform trace after printing a 12-Lead snapshot.

Specifying the 12-Lead Frequency Response

This option allows you to specify the frequency response of the 12-lead waveform display.

You can specify the following trace display ranges:

Display Type	Frequency Response
Diagnostic	0.525 to 150 Hz
Filtered Diagnostic	0.525 to 40 Hz

Note: The display and the recording present the waveform according to the filter setting (Diagnostic or Filtered Diagnostic), but the 12-Lead Interpretive Analysis is always performed using a diagnostic bandwidth that follows the unit's AC Mains filter setting.

Enabling 12-Lead Analysis

This option allows you to enable or disable 12 Lead Analysis. The default is enabled (**On**).

Chapter 15

Manual Defibrillation



Paddles are a defibrillation-protected Type BF patient connection.



ECG leads are a defibrillation-protected Type CF patient connection.

Emergency Defibrillation Procedure with Paddles

Warning! To avoid risk of electrical shock, do not allow electrolyte gel to accumulate on hands or paddle handles.

When defibrillating with paddles, use your thumbs to operate the **SHOCK** buttons in order to avoid inadvertent operator shock. No portion of the hands should be near the paddle plates.

Be sure to use the proper paddles/electrodes based on the size of the patient (adult - large, pediatric - small).

The AutoPulse Plus is only intended for use on adults 18 years of age or older.

Warning!

Determine the Patient's Condition Following Local Medical Protocols

Verify the following:

- Unconsciousness
- Absence of breathing
- Absence of pulse

Begin CPR Following Local Medical Protocols

Request additional assistance.

When the Propaq MD is connected to the AutoPulse Plus the text APLS appears next to first waveform trace on the Propaq MD display in place of Pads. If APLS does not appear on the Propaq MD display, check that the Propaq MD and AutoPulse Plus are properly connected. If APLS still does not appear, or a PADDLE FAULT occurs, discharge energy internally by changing the energy selection, disconnect the Multi-Function Cable and electrodes from the AutoPulse Plus, and connect the Multi-Function Cable directly to the electrodes.

Turn On Unit

Press the green power switch located on the top of the unit. The green, yellow, and red lights at the top of the unit flash on and off, and the unit displays the message *SELF TEST PASSED*.

1 Select Energy Level

Press the **Select Energy** arrows up or down to select the desired energy level. These buttons are located either on the front of the unit or on the STERNUM paddle.

Note: The initial defibrillator pad/external paddle energy selection can be set in Defib/Pacer default settings in the Setup>Supervisor menu. The energy selections listed for Shock 1, Shock 2, and Shock 3 are used only when Basic Auto Energy Escalation is enabled. Otherwise, the values set in Defib/Pacer > Default Settings are used.

The default energy selections for adult patients are:

Shock 1 - 120 joules

Shock 2 - 150 joules

Shock 3 - 200 joules

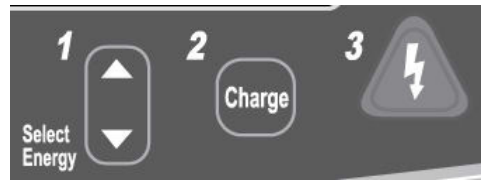
The default energy selections for pediatric patients are:

Shock 1 - 50 joules

Shock 2 - 70 joules

Shock 3 - 85 joules

Note: Neonatal and pediatric defibrillator energy levels should be selected based on site-specific protocols.



or



The selected energy level is displayed at the bottom of the display screen.

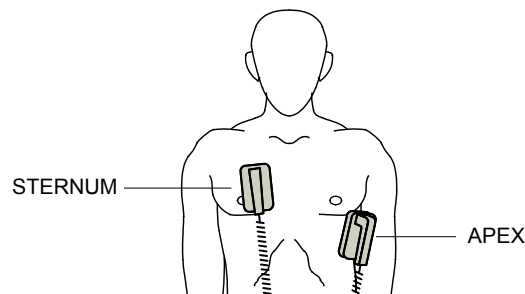
Prepare Paddles

Ensure that the paddles are connected to the multi-function (MFC) or OneStep cable, and that the cable is connected to the Propaq MD unit. Apply a liberal amount of electrolyte gel to the electrode surface of each paddle, and rub the electrode surfaces together to evenly distribute the applied gel. (You can substitute electrode gel patches for the gel.)

Apply Paddles to Chest

Apply the paddles firmly to the anterior wall of the chest. Place the STERNUM paddle to the right of the patient's STERNUM (patient's right), just below the clavicle.

Place the APEX paddle on the chest wall, just below and to the left of the patient's left nipple, along the anterior-axillary line.



Rub the paddles against the skin to maximize the paddle-to-patient contact.

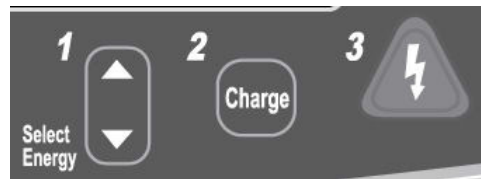
Warning! Do not permit gel to accumulate between the paddle electrodes on the chest wall (gel bridge). This could cause burns and reduce the amount of energy delivered to the heart.

If using defibrillator gel pads, make sure that the size of the pad is large enough to cover the entire paddle electrode area.

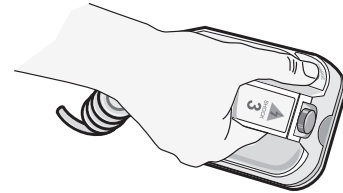
The paddles may be used for ECG monitoring in emergency situations when time does not allow connection of standard ECG monitoring electrodes.

2 Charge Defibrillator

Press the **CHARGE** button on the APEX handle or on the front panel.



or

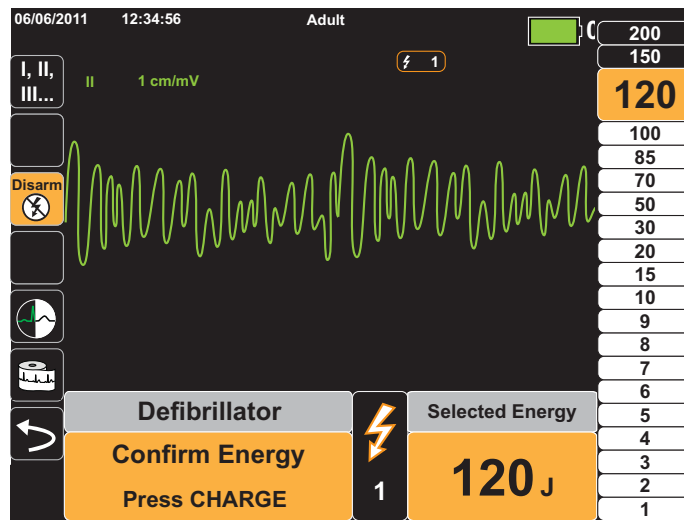


To increase or decrease the selected energy after you have pressed the **CHARGE** button, use the defibrillator **Select Energy** buttons on either the STERNUM paddle or the defibrillator front panel.

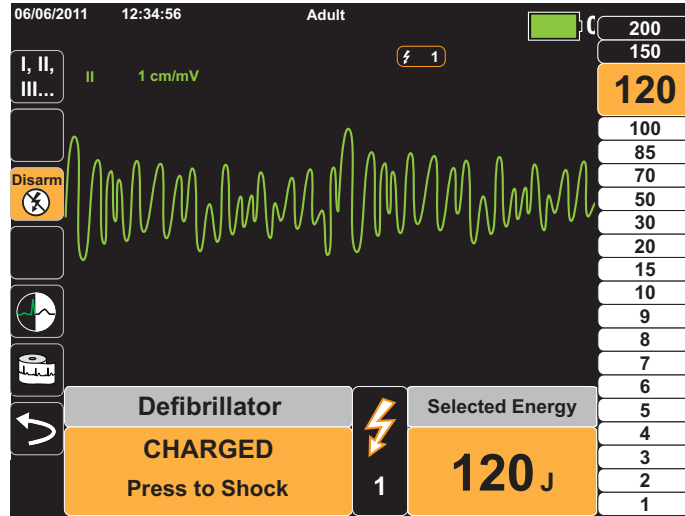
Caution

Changing the selected energy while the unit is charging or charged causes the defibrillator to disarm itself. Press the **CHARGE** button again to charge the unit to the newly selected energy level.

Press the **CHARGE** button again to confirm the charge.



A charging message displays at the bottom of the screen, and a distinctive charging tone sounds indicating that the unit is charging. The energy range bar graph on the right side of the display highlights the charge level until it reaches the selected energy. When the unit is fully charged, the tone changes to a continuous charge ready tone, the highlighted energy bar graph includes the selected energy, and the charge indicator on the APEX paddle lights up.



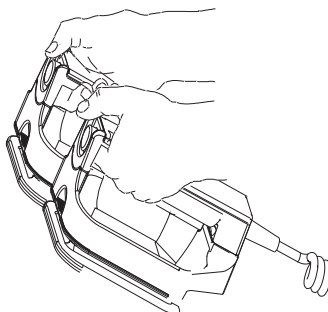
3 Deliver Shock

Warning! Warn all persons in attendance of the patient to **STAND CLEAR** prior to defibrillator discharge.
Do not touch the bed, patient, or any equipment connected to the patient during defibrillation. A severe shock can result. Do not allow exposed portions of the patient's body to come into contact with metal objects, such as a bed frame, as unwanted pathways for defibrillation current may result.

Apply a force of 10 - 12 kilograms (22 - 26.4 pounds) to each paddle in order to minimize patient impedance and achieve optimal results.

Using your thumbs, simultaneously press and hold both **SHOCK** buttons (one on each paddle) until energy is delivered to the patient.

Note: The front panel **SHOCK** button (⚠) is inactive when using external paddles. Pressing this button instead of the paddle **SHOCK** buttons will produce an audible invalid operation tone.



The delivered energy level is displayed at the bottom of the screen and the shock number (1) displays at the top of the screen and in the Defib Control panel at the bottom of the screen.





Note: If at any time you want to cancel the defibrillation, press the **Disarm** quick access key.

If the defibrillator is not discharged within 60 seconds after reaching the selected energy level, the unit automatically disarms itself.

If additional countershocks are needed, follow steps 1 through 3 of this procedure starting on page 2, to readjust the energy settings, charge the unit, and deliver the shock.

Emergency Defibrillation Procedure with Hands-Free Therapy Electrodes

 ZOLL hands-free therapy electrodes are a defibrillation-protected Type BF patient connection.

 ECG leads are a defibrillation-protected Type CF patient connection.

Determine the Patient's Condition Following Local Medical Protocols

Verify:

- Unconsciousness
- Absence of breathing
- Absence of pulse

Begin CPR Following Medical Protocols

Request additional assistance.

Prepare Patient

Remove all clothing covering the patient's chest. Dry chest if necessary. If the patient has excessive chest hair, clip or shave it to ensure proper adhesion of the electrodes.

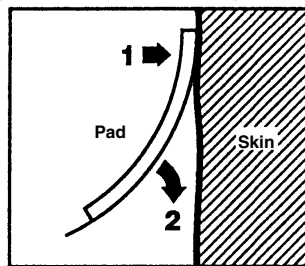
Attach hands-free therapy electrodes according to instructions on the electrode packaging.

Ensure that the therapy electrodes are making good contact with the patient's skin and are not covering any part of the ECG electrodes.

Therapy Electrode Application

Warning! Poor adherence and/or air under the therapy electrodes can lead to the possibility of arcing and skin burns.

1. Apply one edge of the pad securely to the patient.
2. Roll the pad smoothly from the applied edge to the other, being careful not to trap any air pockets between the gel and skin.



Note: If it is not possible to place the “BACK” electrode on the patient's back, place the electrodes in the standard apex-sternum positions. Effective defibrillation results, but pacing will usually be less effective.

Turn On Unit

Press the green power switch located on the top of the unit. The green, yellow, and red lights at the top of the unit flash on and off, and the unit displays the message *SELF TEST PASSED*.

If defibrillation electrodes are not making good contact with the patient's skin and the lead selection is ECG Lead, the unit issues the message *CHECK THERAPY ELECTRODES* and does not allow the delivery of energy.

1 Select Energy Level

Press the **Select Energy** arrows up or down to select the desired energy level. These buttons are located on the front panel of the unit.

Note: The initial defibrillator pad/external paddle energy selection can be set in Defib/Pacer default settings in the Setup>Supervisor menu. The energy selections listed for Shock 1, Shock 2, and Shock 3 are used only when Basic Auto Energy Escalation is enabled. Otherwise, the values set in Defib/Pacer > Default Settings are used.

The default energy selections for adult patients are:

Shock 1 - 120 joules

Shock 2 - 150 joules

Shock 3 - 200 joules

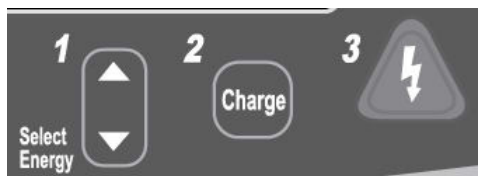
The default energy selections for pediatric patients are:

Shock 1 - 50 joules

Shock 2 - 70 joules

Shock 3 - 85 joules

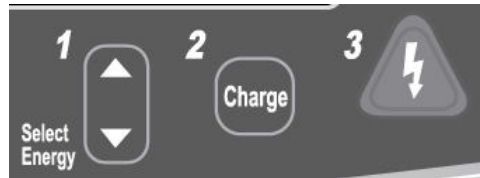
Note: Neonatal and pediatric defibrillator energy levels should be selected based on site-specific protocols.



The selected energy level is shown on the display.

2 Charge Defibrillator

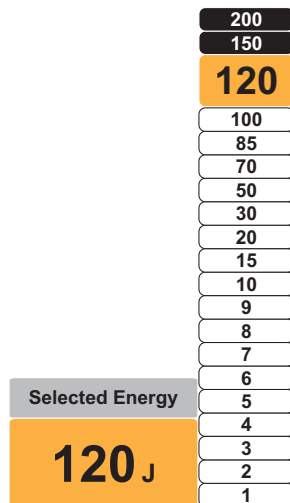
Press the **CHARGE** button on the front panel.



To increase or decrease the selected energy after you have pressed the **Charge** button, use the defibrillator **Select Energy** arrows on the front panel.

Caution Changing the selected energy while the unit is charging or charged causes the defibrillator to disarm itself. Press the **Charge** button again to charge the unit to the newly selected energy level.


A charging message displays at the bottom of the screen, and a distinctive charging tone sounds indicating that the unit is charging. The energy range bar graph on the right side of the display highlights the charge level until it reaches the selected energy. When the unit is fully charged, the tone changes to a continuous charge ready tone, the highlighted energy bar graph includes the selected energy, and the **Shock** button lights up.

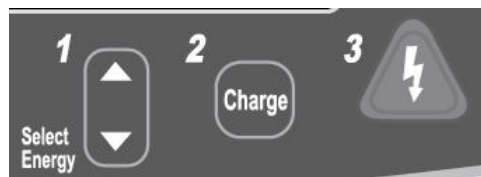


3 Deliver Shock

Warning! Warn all persons in attendance of the patient to **STAND CLEAR** prior to defibrillator discharge.

Do not touch the bed, patient, or any equipment connected to the patient during defibrillation. A severe shock can result. Do not allow exposed portions of the patient's body to come into contact with metal objects, such as a bed frame, as unwanted pathways for defibrillation current may result.

Press and hold the  button on the front panel until energy is delivered to the patient.



The delivered energy level is displayed at the bottom of the screen and the shock number (1) displays at the top of the screen and in the Defib Control panel at the bottom of the screen.



Note: If at any time you want to cancel the defibrillation, press the **Disarm** softkey.

If the defibrillator is not discharged within 60 seconds after reaching the selected energy level, the unit automatically disarms itself.

If additional countershocks are needed, follow steps 1 through 3 of this procedure starting on page 8, to readjust the energy settings, charge the unit, and deliver shock.

Internal Paddles

ZOLL internal paddles are designed for use with the ZOLL Propaq MD defibrillator to defibrillate the heart during open chest procedures. Two types of Autoclavable Internal Handles are available:

- Molded Autoclavable Internal Handles with integrated electrodes
- Autoclavable Internal Handles with removable internal defibrillation electrodes



When an internal handle set is connected to the Propaq MD, it automatically limits defibrillator energy output to a maximum of 50 joules.

For step-by-step procedures for open chest defibrillation as well as important cleaning and sterilization information regarding the autoclavable electrodes, refer to the *Autoclavable Internal Handle and Electrode Operator's Guide*.

Verification Prior to Use

Before each use with the Propaq MD, verify the proper operation of the ZOLL internal paddles using the following procedure. This procedure requires a second person if you are using internal handles without a **Discharge** button.

Warning! **When performing internal paddle verification, keep hands away from the electrode plates while pressing the SHOCK button.**

1. Inspect the connector contact sockets for damage or corrosion. If you observe damage or corrosion in the connector contact sockets, remove the handle set from use.
2. Connect the Autoclavable Internal Handles to the Propaq MD unit. Use the Lead quick access key  to verify that the Propaq MD unit correctly identifies the Internal Handle and Electrode set by displaying **Int. Pdls**.
3. Before charging the defibrillator, press the **Discharge** button on the handle set (if present) and verify that there is an audible click and that the button springs back upon release. Verify that the defibrillator window displays the message *APPLY PADDLES TO PATIENT*. This message verifies that the **Discharge** button located on the right handle is operating correctly.
4. Press the **Select Energy** arrows (located on the front panel of the Propaq MD unit) up or down to select 30 Joules.
5. Press the **Charge** button on the defibrillator front panel to charge the unit to the selected energy level. Wait for the READY tone.
6. Press the electrode plate surfaces firmly together and away from any person or object.
7. Discharge the energy in the following manner.
 - For internal handles with a **Discharge** button:
Press and hold the **Discharge** button on the apex handle to deliver the test energy to the electrodes.
 - For internal handles without a **Discharge** button:
Have a second person press and hold  on the defibrillator front panel to deliver the test energy to the electrodes.

The Propaq MD device unit discharges and displays the message *DEFIB SHORT TEST PASSED*.

Synchronized Cardioversion

Warning! Only skilled personnel trained in Advanced Cardiac Life Support and familiar with equipment operation should perform synchronized cardioversion. The precise cardiac arrhythmia must be determined before attempting defibrillation or cardioversion.

Before attempting synchronized cardioversion, ensure that ECG signal quality is sufficient to minimize the risk of synchronizing on artifact.

Synchronized cardioversion is disabled when the Propaq MD unit is connected to the AutoPulse Plus and the AutoPulse Plus is compressing.

Certain arrhythmias, such as ventricular tachycardia, atrial fibrillation, and atrial flutter, require synchronizing the defibrillator discharge with the ECG R-wave to avoid the induction of ventricular fibrillation. In this case, a synchronizing (SYNC) circuit within the defibrillator detects the patient's R-waves. When the **SHOCK** button (or buttons, if using paddles) is pressed and held, the unit discharges with the next detected R-wave, thus avoiding the vulnerable T-wave segment of the cardiac cycle.

When in the SYNC mode, the unit displays markers (**S**) above the ECG trace to indicate the points in the cardiac cycle (R waves) where discharge can occur.



S marker indicates each detected R wave during synchronization.

Verify that markers are clearly visible on the monitor and their location is appropriate and consistent from beat to beat.

The synchronized cardioversion procedure for ZOLL hands-free therapy electrodes is identical to that for paddles with the exception of the **SHOCK** button location.

Synchronized Cardioversion Procedure

Determine the Patient's Condition and Provide Care Following Local Medical Protocols

Prepare Patient

Remove all clothing covering the patient's chest. Dry chest if necessary. If the patient has excessive chest hair, clip or shave it to ensure proper adhesion of the electrodes.

Attach ECG electrodes (see Chapter 6 for instructions on attaching ECG electrodes to the patient).

A standard ECG cable and ECG electrodes are recommended for use during cardioversion. Hands-free therapy electrodes may be used as an ECG source. Signal quality will be equal to that of standard leads except immediately following a discharge when there may be more noise due to muscle tremors, especially if an electrode is not in complete contact with the skin.

Attach hands-free therapy electrodes according to instructions on the electrode packaging and as described in "Therapy Electrode Application" on page 15-7.

Ensure that the therapy electrodes are making good contact with the patient's skin and are not covering any part of any other electrodes.

If paddles are being used for synchronized cardioversion, refer to "Emergency Defibrillation Procedure with Paddles" on page 15-1 for preparing paddles, applying paddles, charging the defibrillator, and delivering a shock. Note, however, that synchronized discharge with paddles as an ECG source is discouraged since the artifact induced by moving the paddles may resemble an R-wave and trigger defibrillator discharge at the wrong time.

Turn On Unit

Press the green power switch located on the top of the unit. The green, yellow, and red lights at the top of the unit flash on and off, and the unit displays the message *SELF TEST PASSED*.

Press the Sync Button

Press the **Sync** button on the front panel. The system will now be in SYNC mode. A sync marker (**S**) appears on the monitor above each detected R-wave to indicate where discharge will occur. A Sync indicator appears at the top of the display screen, and a green light next to the indicator flashes with each Sync marker.



Note: If the marker does not appear over the R wave, select a different ECG lead. If the sync marker doesn't display, the defibrillator will not discharge.

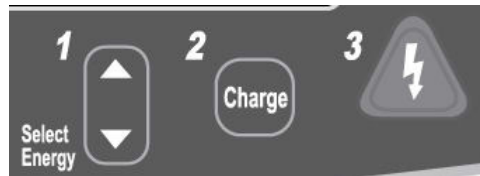
Unless otherwise configured, the unit automatically exits Sync mode after each shock. To reactivate SYNC mode, press the **Sync** button on the front panel again. Changing the selected energy levels does not cause the unit to leave SYNC mode.

Note: The unit can be configured to stay in SYNC mode after defibrillation in Defib/Pacer default settings in the Setup>Supervisor menu.

1 Select Energy Level

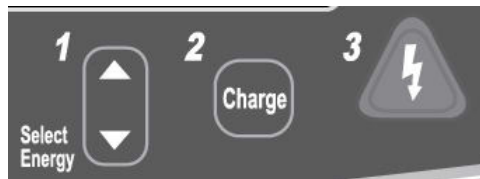
Press the **Select Energy** arrows up or down to select the desired energy level. These buttons are located either on the front of the unit or on the STERNUM paddle.

Warning! When used with pedi-padz, defibrillator energies must be set manually based on site-specific institutional protocols for pediatric defibrillation.



2 Charge Defibrillator

Press the **CHARGE** button on the front panel or on the APEX paddle handle.



or



To increase or decrease the selected energy after you have pressed the **CHARGE** button, use the defibrillator **Select Energy** arrows on the front panel or sternum panel.

Caution Changing the selected energy while the unit is charging or charged causes the defibrillator to disarm itself. Press the **CHARGE** button again to charge the unit to the newly selected energy level.

A charging message displays at the bottom of the screen, and a distinctive charging tone sounds indicating that the unit is charging. The energy range bar graph on the right side of the display highlights the charging progress until it reaches the selected energy. When the unit is fully charged, the tone changes to a continuous charge ready tone, the highlighted energy bar graph includes the selected energy, and the **SHOCK** button lights up.

3 Deliver Shock

Warning! Warn all persons in attendance of the patient to *STAND CLEAR* prior to defibrillator discharge.

Verify that no one is in contact with the patient, monitoring cable or leads, bed rails, or any other potential current pathways.

Verify that the ECG waveform is stable and that sync markers appear over each R-wave.

Press and hold the illuminated **SHOCK** button on the front panel, (or simultaneously press and hold both paddle **SHOCK** buttons) until energy is delivered to the patient. The defibrillator will discharge with the next detected R wave.

The delivered energy level is displayed at the bottom of the screen and the shock number (1) displays at the top of the screen.

Note: If at any time you want to cancel the defibrillation, press the **Disarm** quick access key.

If the defibrillator is not discharged within 60 seconds after reaching the selected energy level, the unit automatically disarms itself.

If additional countershocks are needed (and the **Sync after Cardioversion** setting is disabled), press the **Sync** button again and follow steps 1 through 3 of this procedure starting on page 14, to readjust the energy settings, charge the unit, and deliver shock.

You can configure the **Sync after Cardioversion** setting through the Setup>Supervisor>Defib/Pacer>Default Settings menu.

Chapter 16

Advisory Defibrillation



ZOLL hands-free therapy electrodes are a defibrillation-protected Type BF patient connection.

When the Propaq MD unit is configured for Advisory (or single analysis) defibrillation, the Propaq MD unit can identify shockable rhythms using its built in ECG analysis capability. You must read the advisory messages, charge the defibrillator to the preconfigured or user-selected energy level (if automatic charge is disabled), and deliver treatment to the patient when required by protocol and patient condition.

The advisory function can be activated only when:

- The unit is configured for Single Analysis.
- The unit is on and in manual mode.
- Hands-free therapy electrodes are properly connected to the patient.
- Valid impedance is detected and pacer is off.
- Patient mode is not set to neonate.

WARNING! Use only pediatric electrodes to defibrillate patients under 8 years of age in Advisory mode, and make sure the patient mode is set to pediatric. Use of adult electrodes or adult mode with pediatric patients can result in the delivery of excessive energy doses.

The AutoPulse Plus is only intended for use on adults 18 years of age or older.

Advisory Defibrillation Procedure

Determine the Patient's Condition Following Local Medical Protocols

Verify:

- Unconsciousness.
- Absence of breathing.
- Absence of pulse.

Begin CPR Following Local Medical Protocols

Request additional assistance.

Prepare Patient

Remove all clothing covering the patient's chest. Dry chest if necessary. If the patient has excessive chest hair, clip or shave it to ensure proper adhesion of the electrodes.

Attach hands-free therapy electrodes according to instructions on the electrode packaging and as described in "Therapy Electrode Application" on page 15-7.

Ensure that the electrodes are making good contact with the patient's skin and are not covering any part of the ECG electrodes.

If therapy electrodes are not making good contact with the patient's skin, the unit issues the message *CHECK PADS* and does not allow delivery of energy.

Note: Since analysis is only done using Pads as a lead, even if an ECG cable is connected and Lead II is available, the unit still displays a *CHECK PADS* message.

When the Propaq MD is connected to the AutoPulse Plus the text APLS appears next to first waveform trace on the Propaq MD display in place of Pads. If APLS does not appear on the Propaq MD display, check that the Propaq MD and AutoPulse Plus are properly connected. If APLS still does not appear, or a PADDLE FAULT occurs, discharge energy internally by changing the energy selection, disconnect the Multi-Function Cable and electrodes from the AutoPulse Plus, and connect the Multi-Function Cable directly to the electrodes.

1 Turn on unit

Press the green power switch located on the top of the unit. The green, yellow, and red lights on the top of the unit flash on and off, and the unit displays the message SELF TEST PASSED.

If Unit is in AED Mode

1. Press the **Manual Mode** quick access key on the front panel of the unit to enter the Manual mode of operation.
2. Using the navigation keys, select the four digits in the Manual Mode pass code. Press **SAVE** when you are finished. Once you have entered your pass code, you will be able to enter Manual mode.

Note: If the unit has been not been configured to enter a pass code, the message *Exit to Manual Mode* is displayed. Use the navigation keys to select **Yes** to enter the Manual mode of operation. If you do not press **Yes** within 10 seconds, the unit will revert back to AED operation.

If Unit is in Manual Mode – No additional steps are necessary to proceed.

If no hands-free therapy electrodes have been attached to the patient and connected to the Propaq MD unit, the *ATTACH PADS* message and voice prompt will be issued.

Select Energy

The default energy selections for adult patients are:

Shock 1 - 120 joules

Shock 2 - 150 joules

Shock 3 - 200 joules

The default energy selections for pediatric patients are:

Shock 1 - 50 joules

Shock 2 - 70 joules

Shock 3 - 85 joules

Note: Pediatric defibrillator energy levels should be selected based on site specific protocols.

Warning! Use only pediatric electrodes to defibrillate patients under 8 years of age in Advisory mode, and make sure the patient mode is set to pediatric. Use of adult electrodes or adult mode with pediatric patients can result in the delivery of excessive energy doses.

If medical protocols allow, you may select a different energy level using the select energy up and down arrow buttons on the front panel. The new energy setting displays on the monitor.

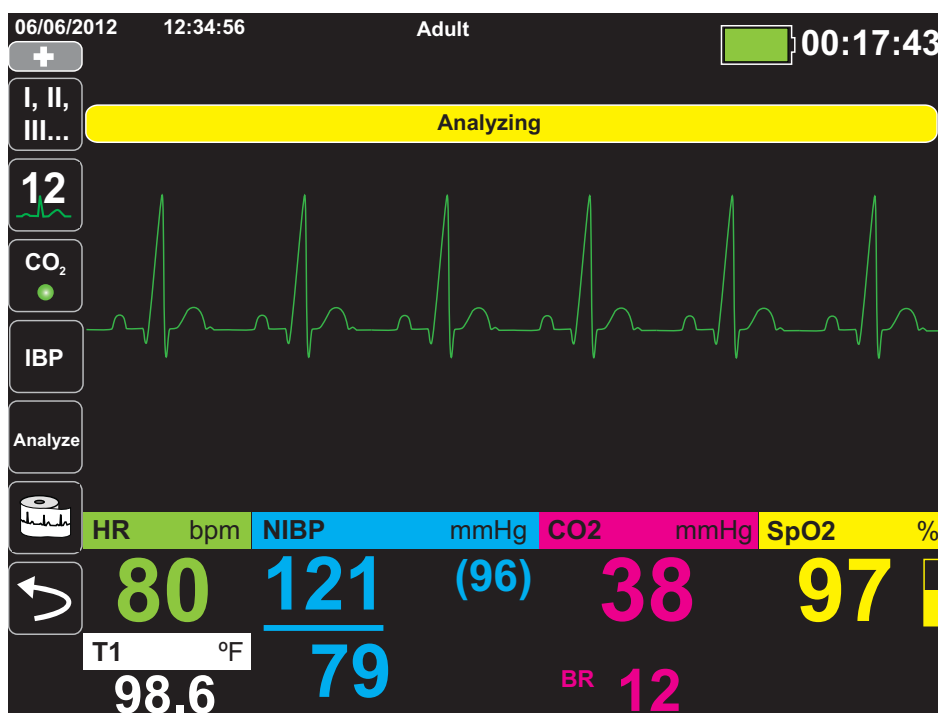
2 Press ANALYZE

Warning! Keep patient motionless during ECG analysis. Do not touch the patient during analysis. Cease all movement via stretcher or vehicle before analyzing the ECG.

When using the AutoPulse Plus, stop compressions prior to performing ECG analysis. Compressions may be resumed following the analysis.

Press the **ANALYZE** quick access key to begin the analysis of the patient's ECG rhythm and to determine if a shockable rhythm is present.

An *ANALYZING* message is displayed at the top of the screen for 6 to 12 seconds while the patient's ECG is analyzed. Once the analysis is completed, the unit indicates whether or not a shock is advised.



The analysis determines whether there is a shockable rhythm. If the analysis detects a shockable rhythm the unit prompts the operator to shock the patient at the preconfigured energy level. If the analysis does not detect a shockable rhythm, the unit alerts the operator that no shock is advised.

Warning! ECG rhythm analysis does not warn of patient asystole, which is not a shockable rhythm.

When a nonshockable rhythm is detected, the unit displays a *NO SHOCK ADVISED* message. Follow the local protocols to continue CPR or other life support, and re-analyze the ECG at appropriate intervals.

Note: When a nonshockable rhythm is detected, the Propaq MD does not prevent the user from manually defibrillating the patient.


When a shockable rhythm is detected (ventricular fibrillation or wide-complex tachycardia with heart rate > 150), the unit will display the *SHOCK ADVISED* message. Press the **Charge** button, and press the **Select Energy** arrows up or down to select the desired energy level if needed. Press **Charge** again to confirm.

Regardless of the analysis result, the user can control the defibrillator manually. For example, the user can defibrillate the patient even if the advisory function issues a *NO SHOCK ADVISED* message.

3 Press SHOCK button

Warning! Warn all persons in attendance of the patient to **STAND CLEAR** prior to defibrillator discharge.

Do not touch the bed, patient, or any equipment connected to the patient during defibrillation. A severe shock can result. Do not allow exposed portions of the patient's body to come in contact with metal objects, such as a bed frame, as unwanted pathways for defibrillation current may result.

Press and hold the **SHOCK** button  on the front panel until energy is delivered to the patient.

The delivered energy level is displayed at the bottom of the screen and the shock number (1) displays at the top of the screen and in the Defib Control panel at the bottom of the screen.



Note: If at any time you want to cancel the defibrillation, press the **Disarm** softkey.

If the defibrillator is not discharged within 60 seconds after reaching the selected energy level, the unit automatically disarms itself.

If additional countershocks are needed, follow steps 1 through 3 of this procedure starting on page 3, to readjust the energy settings, charge the unit, and deliver shock.

Perform CPR

Begin chest compressions and rescue breathing per local protocol.

Repeat Analysis

Press the **ANALYZE** quick access key to restart an ECG analysis and determine if additional shocks are required.

Note: Reanalysis of the ECG rhythm is inhibited for 3 seconds after each shock.

Continue Patient Care

Continue patient care according to medical protocols.

Chapter 17

Analysis/CPR Protocol Defibrillation



ZOLL hands-free therapy electrodes are a defibrillation-protected Type BF patient connection.

When the Propaq MD unit is configured for Analysis/CPR Protocol defibrillation, the unit guides you through a cardiac event by performing ECG analysis, preparing the device for a shock (if needed), and leading you through a CPR interval. This cycle is repeated as long as Analysis/CPR Protocol is active and pads are attached to the patient. If pads become detached from the patient or shorted during rescue protocol, the protocol halts until the pads are reattached or continues through the CPR interval and then halts and waits for the pads to be reattached.

If you press the **Energy Select Up/Down** arrow keys or **Charge** button while in Analysis/CPR Protocol mode, the unit transitions to Manual mode. If the unit is charged when you transition from Analysis/CPR Protocol to Manual mode, the unit disarms and halts any analysis that is taking place.

The Analysis/CPR Protocol function can be activated only when:

- The unit is configured for Analysis/CPR Protocol.
- The unit is on and in manual mode.
- Hands-free therapy electrodes are properly connected to the patient.
- Valid impedance is detected and pacer is off.
- Patient mode is not set to neonate.

Warning! Use only pediatric electrodes to defibrillate patients under 8 years of age in Analysis/CPR Protocol mode, and make sure the patient mode is set to pediatric. Use of adult electrodes or adult mode with pediatric patients can result in the delivery of excessive energy doses.

Analysis/CPR Protocol Defibrillation Procedure

Determine the Patient's Condition Following Local Medical Protocols

Verify:

- Unconsciousness.
- Absence of breathing.
- Absence of pulse.

Begin CPR Following Local Medical Protocols

Request additional assistance.

Prepare Patient

Remove all clothing covering the patient's chest. Dry chest if necessary. If the patient has excessive chest hair, clip or shave it to ensure proper adhesion of the electrodes.

Attach hands-free therapy electrodes according to instructions on the electrode packaging and as described in "Therapy Electrode Application" on page 15-7.

Ensure that the electrodes are making good contact with the patient's skin and are not covering any part of the ECG electrodes.

If therapy electrodes are not making good contact with the patient's skin, the unit issues the message *CHECK PADS* and does not allow delivery of energy.

1 Turn on unit

Press the green power switch located on the top of the unit. The green, yellow, and red lights on the top of the unit flash on and off, and the unit displays the message *SELF TEST PASSED*.

If Unit is in AED Mode

1. Press the **Manual Mode** quick access key on the front panel of the unit to enter the Manual mode of operation.
2. Using the navigation keys, select the four digits in the Manual Mode pass code. Press **SAVE** when you are finished. Once you have entered your pass code, you will be able to enter Manual mode.

Note: If the unit has been not been configured to enter a pass code, the message *Exit to Manual Mode* is displayed. Use the navigation keys to select **Yes** to enter the Manual mode of operation. If you do not press **Yes** within 10 seconds, the unit will revert back to AED operation.

If Unit is in Manual Mode – No additional steps are necessary to proceed.

If no hands-free therapy electrodes have been attached to the patient and connected to the Propaq MD unit, the *ATTACH PADS* message and voice prompt will be issued.

Select Energy

The default energy selections for adult patients are:

Shock 1 - 120 joules

Shock 2 - 150 joules

Shock 3 - 200 joules

The default energy selections for pediatric patients are:

Shock 1 - 50 joules

Shock 2 - 70 joules

Shock 3 - 85 joules

Note: Pediatric defibrillator energy levels should be selected based on site specific protocols.

Warning! Use only pediatric electrodes to defibrillate patients under 8 years of age in Analysis/CPR Protocol mode, and make sure the patient mode is set to pediatric. Use of adult electrodes or adult mode with pediatric patients can result in the delivery of excessive energy doses.

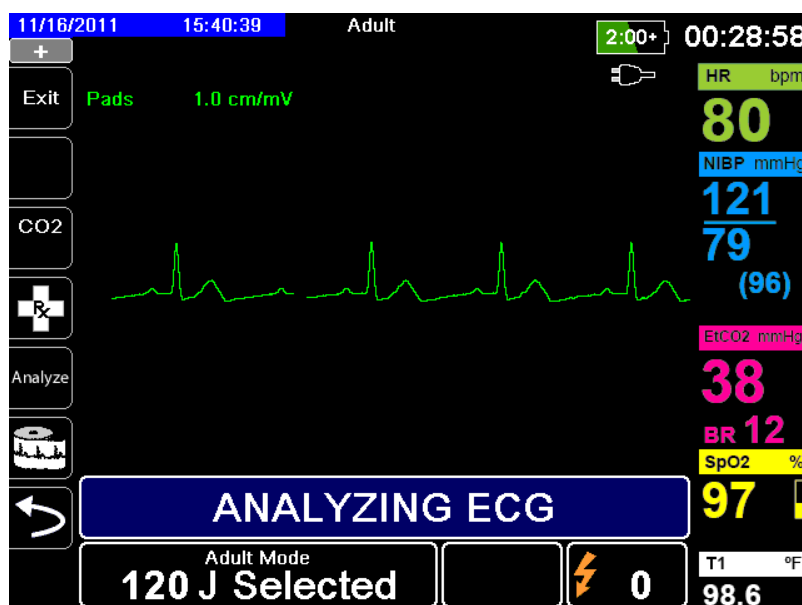
2 Press ANALYZE

Warning! **Keep patient motionless during ECG analysis. Do not touch the patient during analysis. Cease all movement via stretcher or vehicle before analyzing the ECG.**

Press the **ANALYZE** quick access key to begin the analysis of the patient's ECG rhythm and to determine if a shockable rhythm is present.

The *ANALYZING ECG* and *STAND CLEAR* messages alternate at the bottom of the screen while the patient's ECG is analyzed. Once the analysis is completed, the unit indicates whether or not a shock is advised.

Note: You can terminate the Analysis/CPR Protocol mode and return to Manual mode at any time by pressing the **Exit** quick access key.



The analysis determines whether there is a shockable rhythm. If the analysis detects a shockable rhythm the unit prompts the operator to shock the patient at the preconfigured energy level. If the analysis does not detect a shockable rhythm, the unit alerts the operator that no shock is advised.

Warning! **ECG rhythm analysis does not warn of patient asystole, which is not a shockable rhythm.**

When you press the **Select Energy Up/Down** arrow keys or **Charge** button while in Analysis/CPR Protocol mode, the unit transitions to Manual mode. If the unit is charged when you transition from Analysis/CPR Protocol to Manual mode, the unit disarms and halts any analysis that is taking place.

Non-Shockable Rhythm

When a nonshockable rhythm is detected, the unit displays a *NO SHOCK ADVISED* message. The unit then leads you through a CPR interval and then restarts ECG analysis automatically. The Analysis/CPR Protocol mode repeats the Analysis and CPR intervals as long as Analysis/CPR Protocol is active. You can press the **Exit** quick access key at any time to return to Manual mode.

Note: When a nonshockable rhythm is detected, the Propaq MD does not prevent the user from manually defibrillating the patient.

Shockable Rhythm


If the patient's rhythm is shockable, the unit displays the *SHOCK ADVISED* and *PRESS SHOCK* messages. The defibrillator automatically prompts the operator to shock the patient at the preconfigured energy level and the **SHOCK** button illuminates.

A continuous tone sounds for 20 or 50 seconds (depending on configuration), followed by a higher pitch tone for 10 seconds. You must deliver the shock within this 30 or 60 second interval (depending on configuration), or the defibrillator will disarm itself.

3 Press SHOCK button

Warning! Warn all persons in attendance of the patient to **STAND CLEAR** prior to defibrillator discharge.

Do not touch the bed, patient, or any equipment connected to the patient during defibrillation. A severe shock can result. Do not allow exposed portions of the patient's body to come in contact with metal objects, such as a bed frame, as unwanted pathways for defibrillation current may result.

Press and hold the illuminated **SHOCK** button  on the front panel until energy is delivered to the patient.

The delivered energy level is displayed at the bottom of the screen and the shock number (1) displays at the top of the screen and in the Defib Control panel at the bottom of the screen.



The unit then leads you through a CPR interval and then restarts ECG analysis automatically. The Analysis/CPR Protocol mode repeats the Analysis and CPR intervals as long as Analysis/CPR Protocol is active. You can press the **Exit** quick access key at any time to return to Manual mode.

ExpressShock

The ExpressShock analysis algorithm provides ultrafast shock/no-shock decision. It reduces total pause time to as little as 3 seconds. ExpressShock is available in AED mode only or in both AED and Rescue Protocol modes of operation. For further information and how to enable/disable this feature, consult the *Propaq MD Configuration Manual*.

Note: ExpressShock is only available in Adult mode and when one of the following electrodes is used: ZOLL OneStep CPR electrodes, OneStep Complete electrodes, or CPR-D-padz.

WARNING! Performance of the ExpressShock Mode has not been demonstrated in patients under 8 years of age or less than 55 lbs (25 kg).

The Shock Conversion Estimator

Shock Conversion Estimator takes the output of the analysis algorithm and performs additional analysis to estimate the probability of whether or not the current ECG can successfully be converted by electrical therapy. If the probability of a successful shock is low, the system will advise against a shock and instead instruct to continue CPR as this may be more beneficial to victim resuscitation efforts.

For more information on enabling/disabling the Shock Conversion Estimator feature, please refer to the *Propaq MD Configuration Manual*.

WARNING! Performance of the Shock Conversion Estimator has not been demonstrated in patients under 8 years of age or less than 55 lbs (25 kg).

Chapter 18

External Pacing



When ZOLL hands-free therapy electrodes are used, the patient connection is considered to be defibrillation-protected Type BF.



ECG leads are a defibrillation-protected Type CF patient connection.

Warning! Pacing is intended for use on adult patients and on adolescent, child, and infant pediatric patients.

To avoid risk of electrical shock, do not touch the gelled area of the hands-free therapy electrodes while pacing.

Therapy electrodes should be replaced periodically. Consult electrode directions for specific recommendations.

Prolonged pacing (in excess of 30 minutes), particularly in adolescent, child, and infant pediatric patients or adults with severely restricted blood flow, may cause burns. Periodic inspection of the underlying skin is recommended.

When pacing in demand mode, the pacer may be adversely affected from EMI, RFI, or ESU. Move patient away from any potential sources of interference.

External Pacing

Propaq MD defibrillators contain a pacemaker for the emergency treatment of hemodynamically compromising bradycardia, bradycardia with escape rhythms that are unresponsive to pharmacological therapy, refractory tachycardia (supraventricular or ventricular) and bradysystolic cardiac arrest.

Proper demand pacing requires a reliable, high quality surface ECG signal. For best results apply both standard ECG monitoring electrodes and hands-free pacing therapy electrodes to the patient.

Pacer Modes

The Propaq MD has two pacer mode settings: Demand and Fixed. The default factory mode setting is Demand.

In Demand mode, pacing pulses are inhibited by the patient's QRS complexes that occur during an interval that is dependent on the setting of the rate control. If during that interval no QRS complexes are detected, a pacing pulse is delivered to the patient. In the demand mode, the pacer supplies the required number of pacing pulses to maintain the patient's heart rate at approximately the rate selected in the pacing rate window. See the procedure below, "Pacing in Demand Mode" for more information.

In Fixed mode, pacing pulses are not dependent on the patient's cardiac activity. Fixed pacing should be performed only in an emergency when no alternative is available. The pacer delivers pacing pulses at the selected pacing rate. See "Pacing in Fixed Mode" on page 18-6 for more information.

Pacing in Demand Mode

Determine Patient Condition and Provide Care Following Local Medical Protocols.

Prepare the Patient

Remove all clothing covering the patient's chest. Dry chest if necessary. If the patient has excessive chest hair, clip it to ensure proper adhesion of the electrodes.

1 Turn On Unit

Press the green power switch located on the top of the unit. The green, yellow, and red lights at the top of the unit flash on and off, and the unit displays the message SELF TEST PASSED.

2 Apply ECG Electrodes/Hands-Free Therapy Electrodes

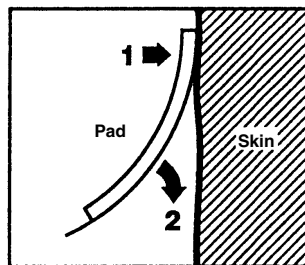
Apply ECG electrodes, attach lead wires, and connect the ECG cable to the Propaq MD side panel (see Chapter 6, "Monitoring ECG" for instructions on attaching ECG electrodes to the patient). Attach hands-free therapy electrodes according to instructions on the electrode packaging. Connect these therapy electrodes to the multifunction cable (MFC).

Note: Do not use ZOLL OneStep cables for pacing.

Therapy Electrode Application

Warning! Poor adherence and/or air under the therapy electrodes can lead to the possibility of arcing and skin burns.

1. Apply one edge of the pad securely to the patient.
2. Roll the pad smoothly from the applied edge to the other, being careful not to trap any air pockets between the gel and skin.



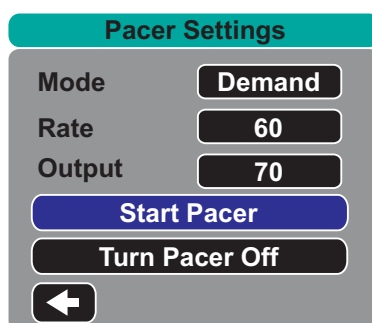
3. Ensure that hands-free therapy electrodes are making good contact with the patient's skin and are not covering any part of any other ECG electrodes.
4. Press the **Lead** quick access key and select I, II, or III to provide the largest amplitude QRS complex.

Note: When the Pacer is on, the lead selection is restricted to Leads I, II, or III.

5. Verify that R-waves are being properly detected by confirming that a QRS tone occurs with each displayed R wave or by verifying that the Propaq MD unit's heart rate display accurately reflects the patient's pulse rate.

3 Press Pacer button

Press the **Pacer** button on the front panel of the unit. The Pacer Settings window displays.



4 Set Mode

Use the arrow keys to navigate to **Mode**, press the **Select** button, and then use the arrow keys and the **Select** button to set the Pacer Mode to Demand.

Note: The initial pacing mode can be set in Defib/Pacer Default settings in the Supervisor Setup menu.

5 Set Pacer Rate

Use the arrow keys to navigate to **Rate**, press the **Select** button, and then use the arrow keys and the **Select** button to set the Pacer Rate to a value 10-20 ppm higher than the patient's intrinsic heart rate. If no intrinsic rate exists, use 100 ppm. You can increase or decrease the pacer rate by a value of 5 ppm for rates below 100, and by 10 ppm for rates above 100.

Note: The initial pacing rate can be set in Defib/Pacer Default settings in the Supervisor Setup menu.

6 Turn On Pacer

Use the arrow keys to navigate to **Start Pacer**, then press the **Select** button to select it. The Pacing window displays behind the Pacer Settings window.

● PACING		
Rate	Output	Mode
80 ppm	95 mA	Demand

7 Set Pacer Output

In the Pacer Settings window, use the arrow keys and the **Select** button to adjust the pacer output. The pacer output is adjustable in 10 mA increments when increasing the output, and in 5 mA increments when decreasing the output. Observe the ECG for evidence of electrical capture. Select the lowest output current that achieves both electrical and mechanical capture.

Note: If the Pacer Settings window disappears before you have set the output current, press the **Pacer** button again to display the settings window.

8 Determine Capture

It is important to recognize when pacing stimulation has produced a ventricular response (capture). Determination of capture must be assessed both electrically and mechanically in order to ensure appropriate circulatory support of the patient.

Electrical capture is determined by the presence of a widened QRS complex, the loss of any underlying intrinsic rhythm, and the appearance of an extended, and sometimes enlarged, T-wave.

Ventricular response is normally characterized by suppression of the intrinsic QRS complex.

Warning! **Determination of electrical capture should only be performed by viewing the ECG trace on the Propaq MD display with its ECG connection directly attached to the patient. Use of other ECG monitoring devices might provide misleading information due to the presence of pacemaker artifacts.**

Mechanical capture is assessed by palpation of the peripheral pulse.

To avoid mistaking muscular response to pacing stimuli for arterial pulsations, use ONLY the following locations for palpating pulse during pacing:

- femoral artery
- right brachial or radial artery

Effective pacing

Changing ECG leads and size can sometimes be helpful in determining capture.

Note: The shape and size of the paced ECG waveforms can vary depending on the ECG lead configuration chosen; variation from patient to patient can be expected.

9 Determine Optimum Threshold

The ideal pacemaker current is the lowest value that maintains capture — it is usually about 10% above threshold. Typical threshold currents range from 40 to 80 mA. Location of the hands-free or therapy electrodes affects the current required to obtain ventricular capture. Typically the lowest threshold is obtained when the position of the electrodes provides the most direct current pathway through the heart while avoiding large chest muscles. Lower stimulation currents produce less skeletal muscle contraction and are better tolerated.

Pacing in Fixed Mode

If ECG electrodes are not available or there is some circumstance that prevents or interferes with the surface ECG, the Propaq MD delivers pacemaker pulses at a fixed rate.

Fixed pacing should be performed only in an emergency when no alternative is available.

1 Turn On Unit

Press the green power switch located on the top of the unit. The green, yellow, and red lights at the top of the unit flash on and off, and the unit displays the message SELF TEST PASSED.

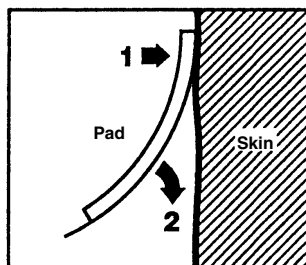
2 Apply ECG Electrodes/Hands-Free Therapy Electrodes

Apply ECG electrodes, attach lead wires, and connect the ECG cable to the Propaq MD side panel (see Chapter 6 for instructions on attaching ECG electrodes to the patient). Attach hands-free therapy electrodes according to instructions on the electrode packaging. Connect these therapy electrodes to the MFC.

Therapy Electrode Application

Warning! Poor adherence and/or air under the therapy electrodes can lead to the possibility of arcing and skin burns.

1. Apply one edge of the pad securely to the patient.
2. Roll the pad smoothly from the applied edge to the other, being careful not to trap any air pockets between the gel and skin.



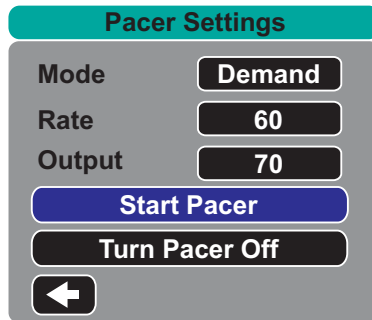
3. Ensure that hands-free therapy electrodes are making good contact with the patient's skin and are not covering any part of any other ECG electrodes.
4. Press the **Lead** quick access key and select I, II, or III to provide the largest amplitude QRS complex.

Note: When the Pacer is on, the lead selection is restricted to Leads I, II, or III.

5. Verify that R-waves are being properly detected by confirming that a QRS tone occurs with each displayed R wave or by verifying that the Propaq MD unit's heart rate display accurately reflects the patient's pulse rate.

3 Press Pacer button

Press the **Pacer** button on the front panel of the unit. The Pacer Settings window displays.



4 Set Mode

Use the arrow keys to navigate to **Mode**, press the **Select** button, then use the arrow keys and **Select** button to set the Pacer Mode to Fixed. The selected mode is displayed in the pacing window.

Note: The initial pacing mode can be set in Defib/Pacer Default settings in the Supervisor Setup menu.

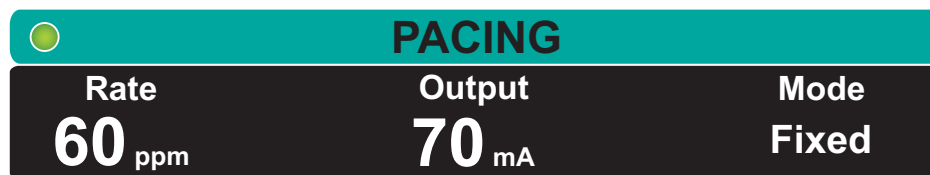
5 Set Pacer Rate

Use the arrow keys to navigate to Rate, press the **Select** button, then use the arrow keys and the **Select** button to set the Pacer Rate to a value 10-20 ppm higher than the patient's intrinsic heart rate. If no intrinsic rate exists, use 100 ppm. You can increase or decrease the pacer rate by a value of 5 ppm for rates below 100, and by 10 ppm for rates above 100.

Note: The initial pacing rate can be set in Defib/Pacer Default settings in the Supervisor Setup menu.

6 Turn On Pacer

Use the arrow keys to navigate to **Start Pacer**, and press the **Select** button to select it. The Pacing window displays behind the Pacer Settings window.



7 Set Pacer Output

In the Pacer Settings window, use the arrow keys and the **Select** button to adjust the pacer output. The pacer output is adjustable in 10 mA increments when increasing the output, and in 5 mA increments when decreasing the output. Observe the ECG for evidence of electrical capture. Select the lowest output current that achieves both electrical and mechanical capture.

Note: If the Pacer Settings window disappears before you have set the output current, press the **Pacer** button again to display the settings window.

8 Determine Capture

It is important to recognize when pacing stimulation has produced a ventricular response (capture). Determination of capture must be assessed both electrically and mechanically in order to ensure appropriate circulatory support of the patient.

Electrical capture is determined by the presence of a widened QRS complex, the loss of any underlying intrinsic rhythm, and the appearance of an extended, and sometimes enlarged, T-wave.

Ventricular response is normally characterized by suppression of the intrinsic QRS complex.

Warning! **Determination of electrical capture should only be performed by viewing the ECG trace on the Propaq MD display with its ECG connection directly attached to the patient. Use of other ECG monitoring devices might provide misleading information due to the presence of pacer artifacts.**

Mechanical capture is assessed by palpation of the peripheral pulse.

To avoid mistaking muscular response to pacing stimuli for arterial pulsations, use **ONLY** the following locations for palpating pulse during pacing:

- femoral artery
- right brachial or radial artery

Effective pacing

Changing ECG leads and size can sometimes be helpful in determining capture.

Note: The shape and size of the paced ECG waveforms can vary depending on the ECG lead configuration chosen; variation from patient to patient can be expected.

9 Determine Optimum Threshold

The ideal pacer current is the lowest value that maintains capture — it is usually about 10% above threshold. Typical threshold currents range from 40 to 80 mA. Location of the hands-free or therapy electrodes affects the current required to obtain ventricular capture. Typically the lowest threshold is obtained when the position of the electrodes provides the most direct current pathway through the heart while avoiding large chest muscles. Lower stimulation currents produce less skeletal muscle contraction and are better tolerated.

Pediatric Pacing

Noninvasive pacing of pediatric patients is performed in an identical manner to adult pacing. Smaller size pediatric therapy electrodes are available for patients weighing less than 33 lbs/15 kg. If it is necessary to pace for more than 30 minutes, periodic inspection of the underlying skin is strongly advised. Carefully follow all instructions on electrode packaging.

Pace Fault

The Propaq MD unit may display the following messages when pacing.

System Message	Description
<i>PAUSED</i>	The pacer has paused pacing the patient.
<i>PACING</i>	The pacer is pacing the patient.
<i>PACING: CHECK THERAPY ELECTRODES</i>	Therapy pads are not connected or are not making good contact with the patient. Apply therapy pads to the patient.
<i>ECG FAULT: PACING IN FIXED MODE</i>	The pacer is pacing in Fixed mode because the ECG lead displayed in the primary waveform is faulted.
<i>PACING: SHORT DETECTED</i>	The pacer output is short circuited due a test plug connection or a device/MFC fault.

Chapter 19

Real CPR Help



Real CPR Help is defibrillation-proof Type BF equipment.

Warning! Do not use Adult CPR electrodes with patients under 8 years of age.

Real CPR Help is disabled when using CPR-D-padz through an AutoPulse Plus.

When used with CPR-D-padz or OneStep CPR electrodes, the Propaq MD unit can provide rescuers with feedback about the quality of CPR they are delivering to their patients. The way in which feedback is provided varies with respect to the operational mode and user configuration, but is derived from compression rate and depth measurements.

When applied according to package instructions, ZOLL CPR-D-padz and OneStep CPR electrodes provide a chest compression sensor that is located between the rescuer's hands and the patient's lower sternum. This sensor monitors the rate and depth of chest compressions and sends this information to the Propaq MD unit for processing and display.

The Propaq MD defibrillator's CPR features include:

- **Voice prompts and text messages** (screen prompts), which give rescuers feedback about the depth of chest compressions.
- **CPR Metronome**, which encourages rescuers to perform chest compressions at the AHA/ERC recommended rate of 100 compressions-per-minute.
- **FULLY RELEASE prompt**, which instructs rescuers to lift (fully release) their hands from the patient's chest after compressions.
- **Real CPR Help Dashboard**, which displays CPR rate and depth measurements, and graphic indicators for CPR Release and Compression.
- **CPR Compression Bar Graph**, which displays a minimum of 12 seconds of compression depth information.
- **See-Thru CPR**, enables the rescuer to see a close approximation of the patient's underlying ECG rhythm while performing CPR (we describe See-Thru CPR in Chapter 20).

The CPR features that the Propaq MD unit provides differ depending whether adult or pediatric CPR electrodes are attached to the unit. The Propaq MD unit automatically senses which type of CPR electrode is attached, and provides the CPR features as follows:

CPR Feature	Adult CPR Features (Available when CPR-D padz and Adult OneStep CPR Electrodes are attached.)	Pediatric CPR Features (Available when Pediatric OneStep CPR Electrodes are attached.)
Voice and Text Prompts	+	
CPR Metronome	+	+
<i>FULLY RELEASE</i> Prompt	+	
CPR Rate and Depth Measurements (CPR Dashboard)	+	+
CPR Release Indicator (CPR Dashboard)	+	
CPR Depth Indicator (CPR Dashboard)	+	
CPR Countdown Timer (CPR Dashboard)	+	+
CPR Depth Idle Time Display (CPR Dashboard)	+	+
CPR Compression Bar Graph	+	

We describe the Propaq MD defibrillator's CPR features in the following sections.

CPR Voice Prompts (Adult Only)

The Propaq MD unit can be configured to issue voice prompts related to the depth of chest compressions as feedback to rescuers performing CPR. Two voice prompts are available for this purpose:

- Push Harder
- Good Compressions

When chest compressions are detected but their depth is consistently less than the target depth (AHA/ERC 2005: 1.75, AHA/ERC 2010: 2.0), the device periodically issues the “Push Harder” voice prompt. If the rescuer responds by increasing compression depth to more than the target depth on a consistent basis, the unit issues a “Good Compressions” prompt.

CPR voice prompts are only available when using Adult CPR electrodes.

CPR Metronome

The Propaq MD unit includes a CPR metronome feature that can be used to encourage rescuers to perform chest compressions at the AHA/ERC recommended rate of 100 compressions per minute.

The CPR metronome can be configured to operate in all modes (AED, Manual, and Analysis/CPR Protocol), or in AED mode only. The CPR metronome can also be disabled for all modes. When activated, the metronome beeps at the AHA/ERC recommended rate to provide a compression rhythm for rescuers to follow.

The CPR metronome’s Constant Metronome feature allows the metronome to continue beeping under certain circumstances. When Enable Metronome is set to Never in the Supervisor>CPR menu, Constant Metronome is greyed out.

The CPR metronome can be configured as follows.

Constant Metronome Enabled

AED Mode

- If Enable Metronome is set to Always or AED Mode Only, the metronome is active when chest compressions are first detected during the CPR interval. The metronome is silent when the CPR idle timer starts.
- If set to Never, the metronome is silent.

Analysis/CPR Protocol or Manual Mode

- If Enable Metronome is set to Always, the metronome is active when chest compressions are first detected during the CPR interval. The metronome is silent when the CPR idle timer starts.
- If set to AED Mode Only or Never, the metronome is silent.

Constant Metronome Disabled

AED Mode

- If Enable Metronome is set to Always or AED Mode Only, the metronome is active when chest compressions are first detected during the CPR interval.
- If set to Never, the metronome is silent.

Analysis/CPR Protocol or Manual Mode

- If Enable Metronome is set to Always, the metronome is active only when the reported compression rate falls below 80 cpm during the CPR period. If the chest compression sensor is connected, the metronome is suspended after compressions have not been detected for at least 2 seconds.
- If set to Never or AED Mode Only, the metronome is silent.

The following table indicates when the CPR metronome is active.

Enable Metronome Setting	AED Mode	Analysis/CPR Protocol Mode	Manual Mode
Constant Metronome Enabled			
AED Mode Only	On when CPR detected Off when CPR Idle	Off	Off
Always	On when CPR detected Off when CPR Idle	On when CPR detected Off when CPR Idle	On when CPR detected Off when CPR Idle
Never	Off	Off	Off
Constant Metronome Disabled			
AED Mode Only	On at start of CPR period	Off	Off
Always	On at start of CPR period	On only at <80 compressions per minute	On only at <80 compressions per minute
Never	Off	Off	Off

FULLY RELEASE Prompt

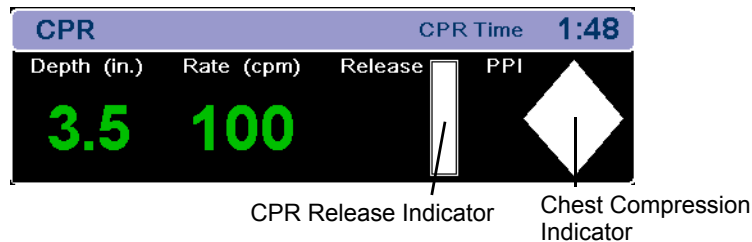
The Propaq MD unit can be configured to display the text prompt FULLY RELEASE, which instructs rescuers to lift (fully release) their hands from the patient's chest after compressions to allow full recoil. This prompt occurs 45 seconds into the CPR interval.

The *FULLY RELEASE* text prompt is only available when using Adult CPR electrodes.

CPR Dashboard

Whenever CPR-D-padz or OneStep electrodes are connected to the Propaq MD defibrillator and it senses compression, the unit illuminates the CPR Dashboard in the lower center portion of the display.

The CPR Dashboard displays CPR feedback indicators, which differ, depending on whether adult or pediatric CPR electrodes are attached to the unit. We describe the CPR Dashboard's feedback indicators in the following sections.



Note: If no compressions have been detected for at least 3 seconds or if the compressions fall below the display range of rate and depth indicators, the rate Depth and Rate fields display dashes (----).

CPR Rate and Depth Measurements

The display of CPR rate and depth measurements differ depending on whether adult or pediatric CPR electrodes are attached.

With Adult CPR Electrodes Attached --

By default, the Propaq MD unit displays CPR rate and depth measurements in green when adult CPR electrodes are attached. If the unit detects that CPR performance is consistently below the AHA/ERC-recommended compression rate, the unit displays the rate measurement in yellow (*needs improvement*). Likewise, if the unit detects that compression depth is consistently below the AHA/ERC-recommended compression depth, the unit displays the depth measurement in yellow (*needs improvement*).

This color coding is intended to assist the rescuer in determining whether the chest compression rate or depth should be increased or maintained.

With Pediatric CPR Electrodes Attached --

CPR rate and depth measurements *always* display in green when pediatric CPR electrodes are attached.

CPR Release Indicator (Adult Only)

The CPR Release Indicator is intended to provide feedback on the rescuer's ability to fully lift his hands off the sternum during the upstroke of the compression. The release indicator is filled when rescuers release compressions more quickly, whereas the indicator will only fill partially if chest compression release is slow.

The CPR Release Indicator is only available when using Adult CPR electrodes.

Chest Compression Indicator (Adult Only)

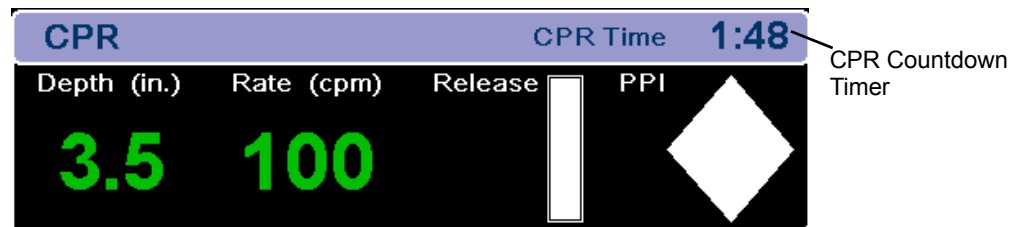
This diamond-shaped figure provides a quick, overall indicator of how well the rescuer's combined rate and depth of chest compressions match the AHA/ERC recommendations for adult CPR.

The CPR Compression Indicator, also known as Perfusion Performance Indicator (PPI), is first displayed as an empty diamond. This indicator starts to fill as compressions begin (filling from the inside), and becomes completely filled when consistent chest compression depth exceeding (AHA/ERC 2005: 1.75, AHA/ERC 2010: 2.0) inches and rate exceeding 90 compressions per minute (cpm) are achieved simultaneously. Should the chest compression rate or depth begin to fall below the configured target levels, the indicator will only partially fill to indicate the need for more rigorous efforts. Following the cessation of compressions, the indicator's fill level gradually decreases until a hollow outline is displayed after a short period of time.

The CPR Compression Indicator is only available when using Adult CPR electrodes.

CPR Countdown Timer

The Propaq MD unit displays a CPR Countdown Timer to indicate the time (in minutes and seconds) left in the current CPR interval. It decrements the time until it reaches zero. The CPR dashboard disappears if the CPR electrodes are disconnected.



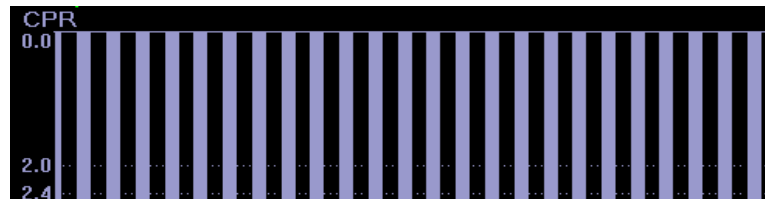
CPR Idle Time Display

This display indicates the elapsed time in minutes and seconds since the last detected chest compression. Ten seconds following the cessation of compressions, the idle time is displayed. As soon as a new compression is detected, the idle time is removed from the screen. If no compressions have been detected for at least 20 minutes, dashes (- - : - -) are displayed in this time field.



CPR Compression Bar Graph (Adult Only)

When Adult CPR electrodes are attached, the Propaq MD unit can display a CPR compression bar graph next to the dashboard that is computed from the CPR sensor signals. This bar graph, representing depth of compression, is presented on a (AHA/ERC 2005: 0 - 2.1, AHA/ERC 2010: 0 - 2.5) inch displacement scale with reference markers at (AHA/ERC 2005: 1.5 and 2.0, AHA/ERC 2010: 2.0 and 2.4) inches. The unit displays a minimum of 12 seconds of compression data at a rate of approximately 133 compressions per minute.



The CPR Compression Bar Graph is only available when using Adult CPR electrodes.

Chapter 20

See-Thru CPR

See-Thru CPR is an optional feature in the Propaq MD.

WARNING! The See-Thru CPR filter works only when the Propaq MD defibrillator is monitoring CPR in Manual mode.

The See-Thru CPR filter stops if:

- The unit is in pace mode.
- Patient impedance is invalid.
- ZOLL OneStep CPR electrodes, OneStep Complete electrodes or CPR-D-padz are no longer detected.

The See-Thru CPR filter will not remove all CPR artifact. Always stop CPR to verify the patient's ECG rhythm before making treatment decisions.

The See-Thru CPR filter does not operate during ECG rhythm analysis. Always stop chest compressions during ECG rhythm analysis to avoid incorrect results caused by the presence of CPR artifact.

Diagnostic bandwidth is never applied to the See-Thru CPR waveform.

The See-Thru CPR filter does not operate when pads are connected through an AutoPulse Plus.

See-Thru CPR enables the rescuer to see a close approximation of the patient's underlying ECG rhythm while performing CPR. See-Thru CPR is available if the Propaq MD is monitoring CPR.

Chest compressions introduce *CPR artifact* into the ECG signal. See-Thru CPR uses a filter that relies on the correlation between CPR compressions, as detected by the ZOLL Onestep, OneStep Complete or CPR-D-padz, and the CPR artifact to remove much, but not all, of the artifact from the ECG signal. Under some conditions, residual noise after filtering can obscure the ECG rhythm, requiring the rescuer to stop CPR to assess the ECG. For example, in the case of asystole or low amplitude PEA, the residual artifact seen after filtering may look like fine ventricular fibrillation.

Because the filtered ECG signal may contain residual chest compression and/or filtering artifacts, *a rescuer should always follow the standard procedure of stopping CPR to assess the patient's ECG rhythm before determining treatment.*

Using See-Thru CPR

To use See-Thru CPR

- The Propaq MD unit must be monitoring CPR.
- ZOLL OneStep CPR pads, OneStep Complete pads, or CPR-D-padz must be attached to the unit.

When chest compressions begin, the Propaq MD unit *automatically* starts filtering the CPR artifact after detecting the first 3 to 6 compressions. The filtered ECG, with the label “FIL,” may be displayed on the second by selecting **FILT ECG** in the Trace2, Trace3 or Trace4 menu. (If selected in the Trace3 or Trace4 menu, the filtered ECG will automatically be moved up to the second trace.)

See-Thru CPR filtering continues as long as the OneStep CPR, OneStep Complete or CPR-D-padz detect compressions and patient impedance is valid. When no compressions are detected or one of the conditions noted above occurs, See-Thru CPR filtering stops, and unfiltered ECG signals are displayed. When compressions resume, filtering automatically restarts after 3 to 6 chest compressions.

Note: There is a delay of approximately 1/16 second between the See-Thru CPR waveform and the Trace 1 ECG waveform.

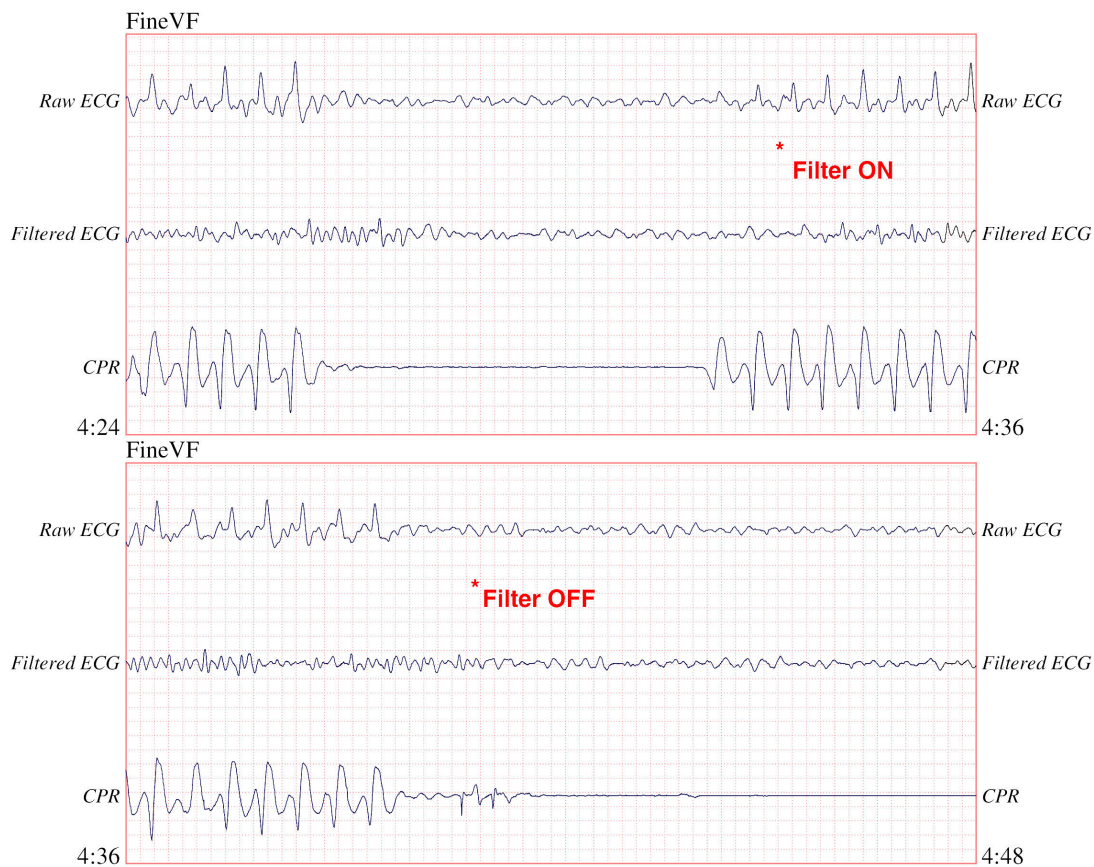
Examples

The following examples show the effects of See-Thru CPR filtering on ECG signals contaminated with CPR artifacts.

Each example includes:

- ECG signal with CPR artifact.
- ECG signal after the See-Thru CPR filter has removed CPR artifact.
- Indication of the period during which See-Thru CPR is active.
- CPR signal to show when CPR activity occurred.

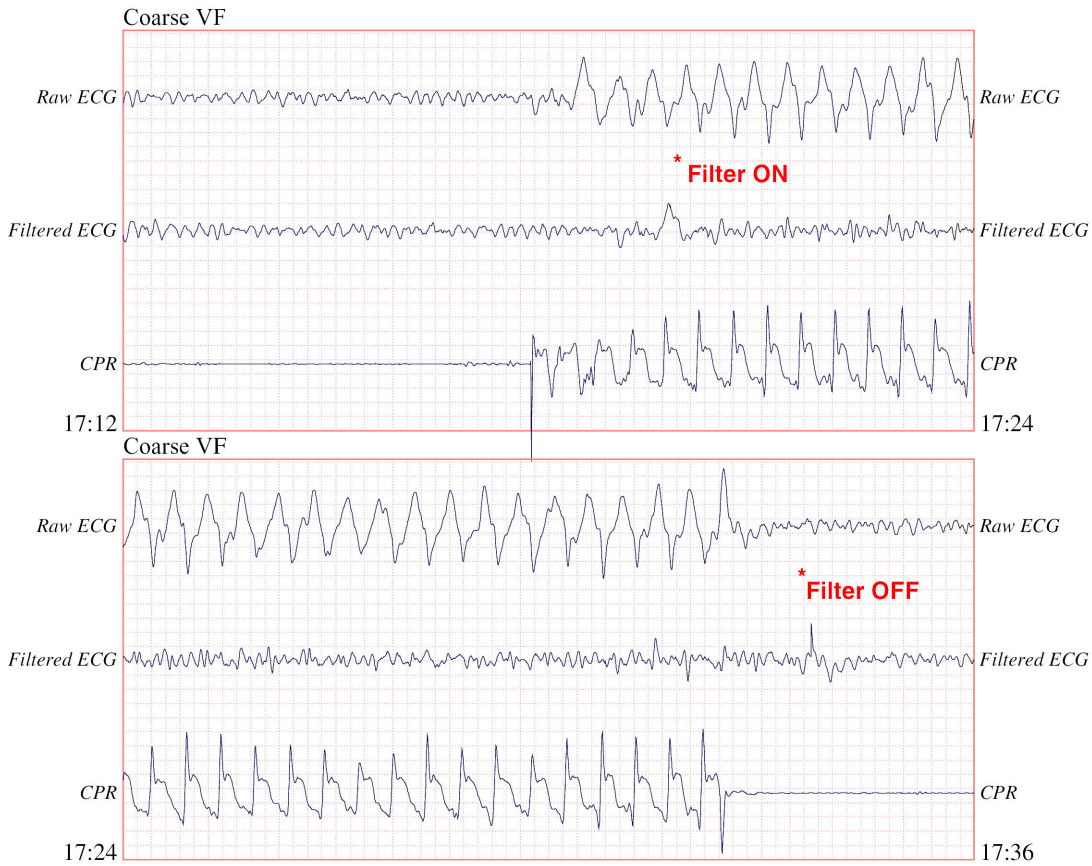
The following figure shows a patient in Fine VF. It is difficult for a rescuer to discern this rhythm during CPR compressions. When the CPR filter turns on, the Fine VF rhythm becomes more obvious.



Copyright © Massachusetts Institute of Technology 2011. All rights reserved.

12.5 mm/sec, 5 mm/mV

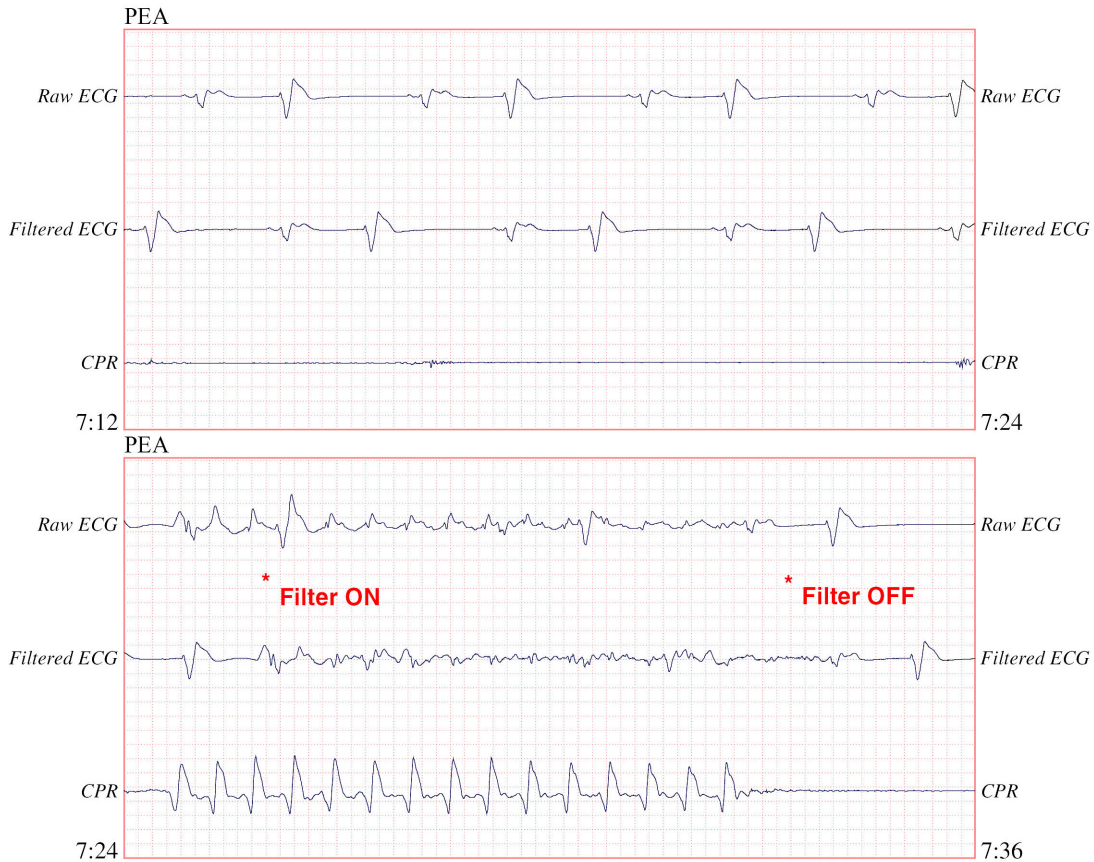
The following figure shows a patient in VF, which, during compressions, is slightly more difficult to discern. When viewing this ECG, it is possible to view the underlying rhythm as the filter is able to reject all of the CPR artifact.



Copyright © Massachusetts Institute of Technology 2011. All rights reserved.

12.5 mm/sec, 5 mm/mV

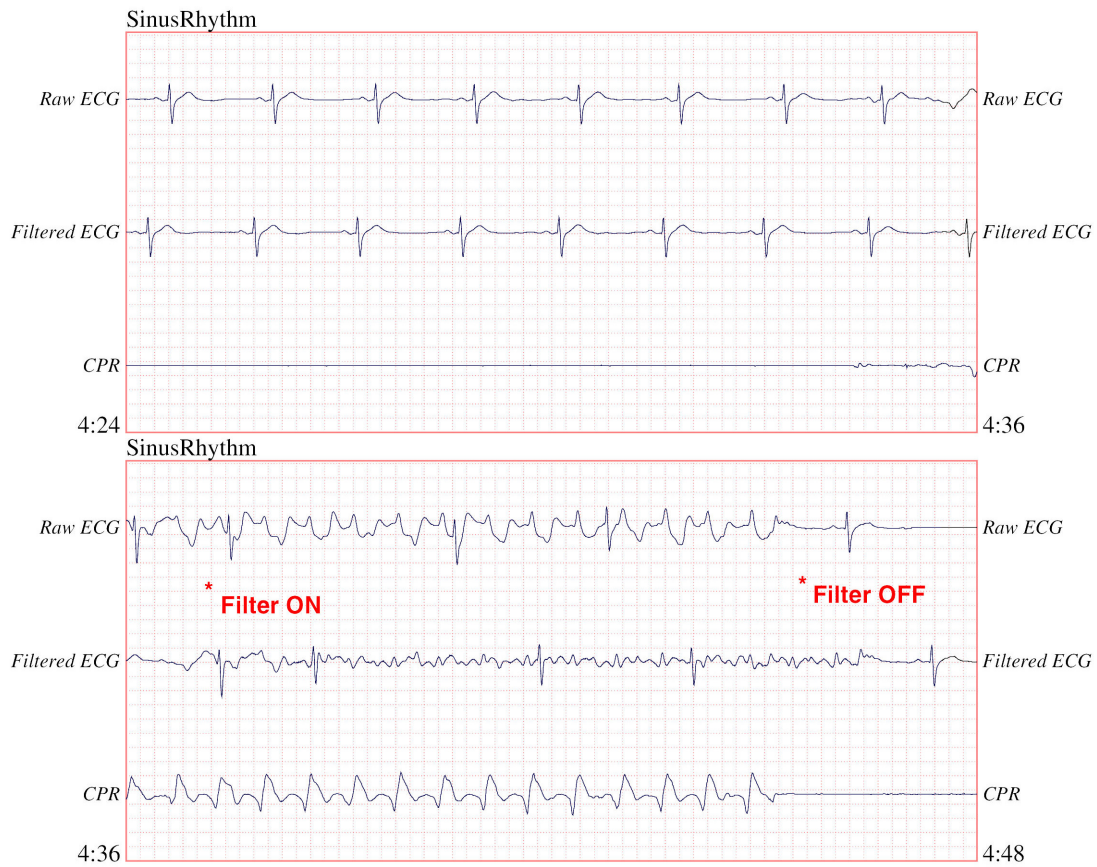
The following figure shows a patient in PEA, which could easily be mistaken for Fine VF because enough of the compression artifact leaks through to distort this signal. When the CPR filter turns on, the PEA is still not obvious because of the left over ripples from the CPR signal. About 14 seconds into this chart, the rhythm changes to asystole, which could easily be mistaken for coarse VF. When the CPR filter turns on, the CPR compression ripples are still obvious, making the rhythm look like Fine VF.



Copyright © Massachusetts Institute of Technology 2011. All rights reserved.

12.5 mm/sec, 5 mm/mV

The following figure shows a patient with an organized rhythm where See-Thru CPR effectively filters out artifact created by CPR.



Copyright © Massachusetts Institute of Technology 2011. All rights reserved.

12.5 mm/sec, 5 mm/mV

Chapter 21

Patient Data

This chapter describes procedures for storing, viewing, and transferring patient data from the Propaq MD to an external system, such as a personal computer or handheld device.

Note: Before deleting log files from the Propaq MD, view the files on a personal computer to verify that they have been successfully transferred.

Note: Data transfers will not be successful if the USB flash storage device is full or does not have sufficient memory available. Always use a USB flash storage device that has at least 128 MB available.

Warning! Do not connect non-isolated equipment to the USB port while monitoring a patient.

Storing Data

The Propaq MD unit continuously stores information in a full disclosure case log for the patient being monitored. The Propaq MD can maintain up to 150 full disclosure cases that contain treatment events, trends, ECG and other continuous waveforms, monitoring and event snapshots, and 12-lead snapshots and analysis. The Propaq MD unit can, at a minimum, concurrently store the following information:

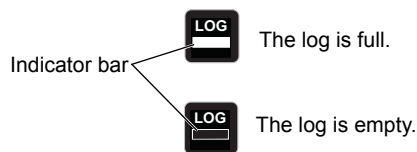
- 32 monitor snapshots
- 500 non-ECG events
- 24 hours of continuous ECG (4 waveforms), Capnography, IBP (3 channels), and Pads Impedance

The actual information that is stored depends on usage. Also, the specific combination of stored continuous waveform data depends on how the waveform recording settings are configured in the Supervisor menu.

Note: The Propaq MD unit retains stored cases even if you turn off or remove the auxiliary power adapter.


Log Capacity Indicator

The Log quick access key has an indicator bar which shows an approximation of the current level of data storage in the log.



When data storage reaches its capacity, the unit performs automatic log management by deleting the oldest full disclosure case. If the log is not cleared or transferred, the Propaq MD unit continues to delete cases as needed to acquire storage capacity. For more information on clearing or transferring the log, see page 4.

Capturing a Data Snapshot

Press the **Snapshot** button () on the front panel to capture a 24-second period of numeric and waveform patient data. The unit captures 12 seconds preceding and 12 seconds following the button press.


The Propaq MD unit can store a minimum of 32 snapshots, including

- Monitor snapshots
- Defibrillator snapshots
- Treatment snapshots
- Pacer snapshots
- Alarm snapshots
- Presenting Rhythm snapshots

Note: Presenting Rhythm snapshots are only taken at the start of a new patient. The snapshot will not be retaken if the unit is shut off for less than two minutes.

Reviewing and printing snapshots

You can perform this procedure from any main display screen.

1. Press the **Home/Display** button () repeatedly until the Trends window displays.
2. Use the navigation keys to get to the Trends window.
3. Press the **Select** button to scroll through the list of trends.

Note: The snapshots have a snapshot icon next to the time stamp.

4. Select the desired snapshot from the Trends list and press **Select**. The snapshot numeric data displays.
5. To print the data and the snapshot waveforms, highlight **Print this Snapshot** and press **Select**.

Note: If you attempt to print a snapshot before the unit has finished storing the snapshot in the log, a *NO DATA AVAILABLE* message is printed. To print the snapshot correctly, wait until the snapshot is complete, then select and print it again.

Treatment Summary Report




The Treatment Summary Report is a report that shows all of the treatment events related to a patient such as defibrillation/pacer events, alarm events, and treatment snapshots. It is helpful to print out this report at the end of a case.

TREATMENT SUMMARY REPORT

Name: Phillip Davies	06:06:14	New Case ID
ID: Patient 0015	Patient Mode: Adult	06:06:14
Start Time: 06/06/12	06:06:14	06:06:14
Last Event: 06/06/12	09:43:40	06:06:14
Elapsed Time: 00:29:48	# Events:	06:06:20
Total Shocks: 1	06:06:43	06:06:43
Total Pace Time: 00:00:00		
Total 12 Leads: 0		
Dept: ICU		
Unit:		
S/N: 0 SW: 00.00.00.00		

Printing Treatment Summary Report

To print a treatment summary report, do the following:

1. Press the **More** quick access key (.
 2. Press the **Log** quick access key (.
 3. Press the **Treatment Summary** quick access key (). The Treatment Summary window displays.
 4. Use the navigation keys to highlight and select the treatment summary you want to print.
- Note:** The Treatment Summary Report that you selected has a check mark next to it.
5. Use the navigation keys to highlight and select **Print Treatment Summary**.

Transferring Data to a USB Device

You can transfer patient data from the unit using a USB transfer device.

Before you begin, insert a USB device into the Propaq MD USB device port.

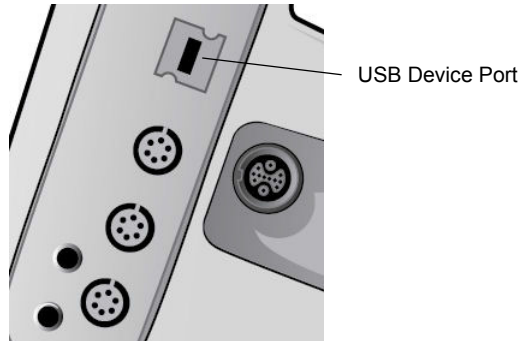





Figure 21-1 USB Port

To transfer data through the USB port:

1. Press the power switch to turn the unit on.
2. Press .
3. Press .
4. Press the **Transfer Log** quick access key () (ensure that the USB drive is connected to the device).

Note: Do not remove the USB data drive from the Propaq MD unit during transfer.

5. Use the navigation keys to select **Transfer** from the Transfer the Log menu.

6. The green LED on the top of the device turns on while data is transferred to the USB device.

Note: Wait for the log transfer to complete and for the green light on the top of the Propaq MD to turn off before removing the USB drive.

Note: Printing and logging snapshots is disabled during the log transfer.

After transferring data, you must remove the USB drive and reinsert it before attempting another transfer. If the USB device does not establish communication with the Propaq MD unit, try powering off the unit and then on again to establish communication.




Warning! To avoid a possible shock hazard, do NOT make any electrical connections to the USB port except to connect a USB flash drive while in the vicinity of the patient.

Clearing the Log

You should clear the patient data log after transferring data to the USB device or when the log is full.

Note: Clearing the log during patient treatment results in the loss of all patient data and events recorded prior to clearing the log.

To clear the log:

1. Press .
2. Press .
3. Press the **Clear Log** quick access key ().
3. Use the navigation keys to select **Yes**.

Note: An *UNABLE TO READ LOG* message indicates that the log contains no information. This message can occur if you clear the log and then immediately enter the Treatment screen or the Trend Summary screen.

Chapter 22

Communications

If installed, the Propaq MD unit is equipped to communicate through a WiFi access point, Bluetooth-equipped device, Ethernet cable, or USB cellular modem. You can send data through a wireless connection to a remote recipient via a ZOLL server configured for your unit or you can use an Ethernet adapter to transfer data to a PC via an Ethernet cable. The data available to transmit to a remote location includes 12-lead report snapshots (including trend data) as well as the Disclosure logs for up to 15 cases at one time. The Propaq MD unit continuously stores information in a full disclosure case log for monitored patients. The disclosure logs contain treatment events, trends, ECG and other continuous waveforms, monitoring and event snapshots, and 12-lead snapshots and analysis.

Note: Full disclosure cases, can also be automatically retrieved from the Propaq MD unit using ZOLL RescueNet or ePCR software or saved to a USB device.

You can set up a Bluetooth pairing or temporary wireless access point on the Propaq MD unit by selecting the wireless icon on the display screen. Supervisors can set up permanent communications configuration, including up to 255 Wi-Fi profiles and up to 3 Cellular providers in the Setup/Communications menu, which requires a password. Once you have set up a wireless connection, you can send 12-lead reports or disclosure logs via a ZOLL server.






This chapter describes how to set up and use communications capabilities in the Propaq MD unit. This chapter contains the following sections:

- The Wireless Icon
- The Wireless Menu
- Sending a 12-Lead Report
- Sending Disclosure Logs
- Supervisor Communications Menu
- Communications System Messages
- Transmission Status Icons

Important: Test all wireless connections after initial setup and prior to use.

The Wireless Icon

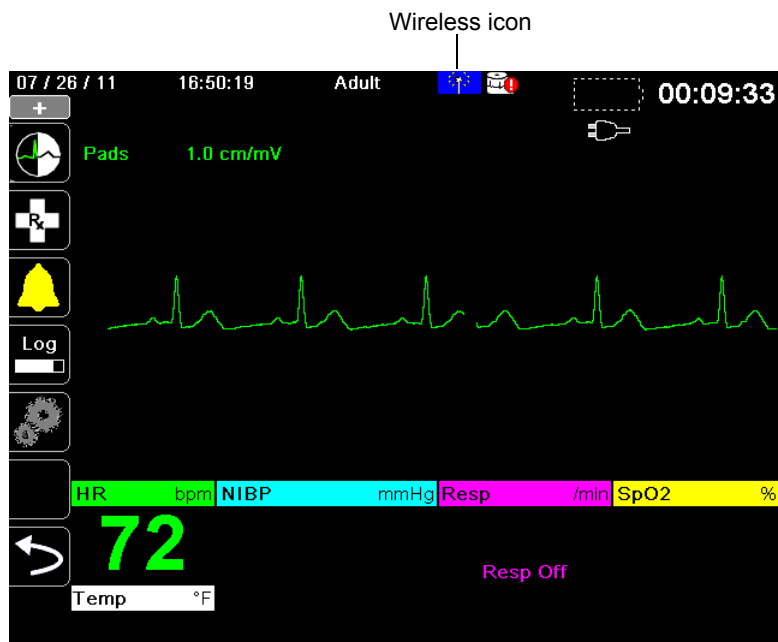
The wireless icon is located to the right of the patient mode in the display screen. It has five possible states shown the table below. If wireless connectivity is disabled, no icon is displayed.

State	Description
Connected 	Wireless connectivity is active using WiFi, Bluetooth, or USB cellular modem. For Wifi, this is the normal operating state. For Bluetooth or cellular modem, this icon appears only when a transmission is requested.
Not connected 	Wireless connectivity is inactive. If a WiFi access point is selected, this icon indicates the selected network cannot connect due to incorrect configuration or weak/no signal strength. If the unit is configured to use Bluetooth or cellular modem, the unit will show this icon until a transmission is requested.
Failed 	Wireless communication hardware has failed.
Ethernet Connected 	Replaces the wireless icon when Ethernet is enabled. An adapter is connected, and the connection is operating.
Ethernet Not Connected 	Replaces the wireless icon when Ethernet is enabled. An Ethernet adapter is connected, but the connection is not operating.
No icon	All wireless connectivity is disabled.

You can select the Wireless icon to access the Wireless menu where you can:

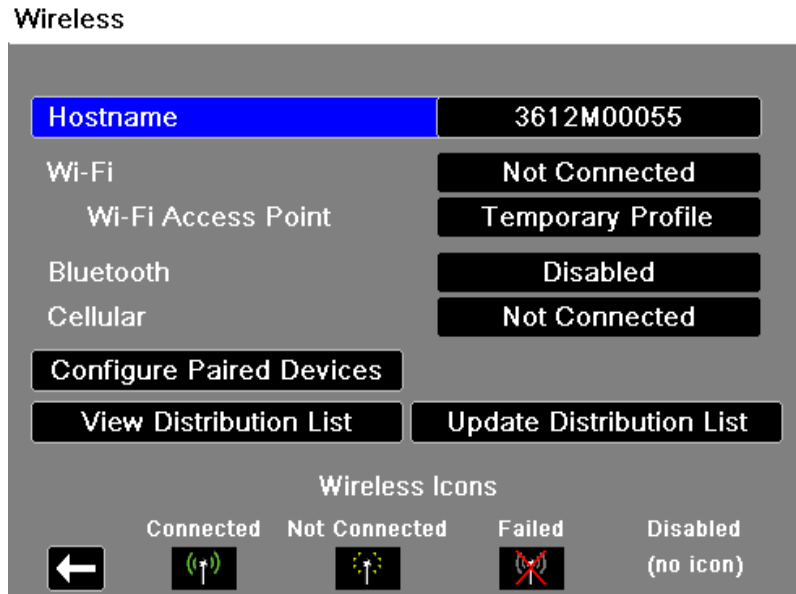
- Select preconfigured WiFi access points
- View connection details
- View Bluetooth paired devices
- View or update 12-Lead distribution lists
- Set up a temporary WiFi access point
- Set up a Bluetooth connection.

Use the navigation keys to select the wireless icon.



The Wireless Menu

The Wireless menu has the following options: **WiFi Access Point**, **View/Configure Paired Devices**, **View Distribution List**, and **Update Distribution List**. Use the navigation keys to navigate the menu items; press the back arrow (←) to exit the wireless menu.



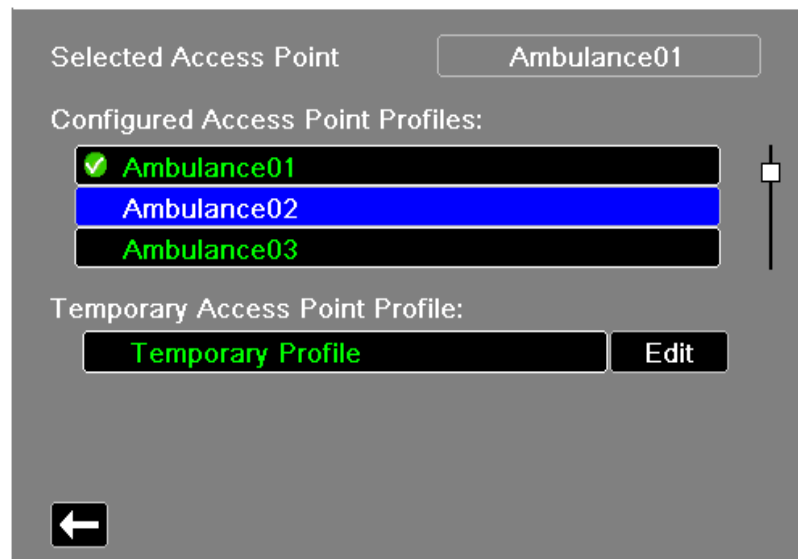
Selecting a Pre-Configured Access Point Profile

You can make a wireless Access Point profile active by selecting an access point from a list of pre-configured wireless Access Point profiles.

To make an Access Point Profile active:

1. Use the navigation keys to highlight and select **WiFi Access Point**. The Select Access Point Profile dialog box displays with a list of available pre-configured Access Point Profiles.

Wireless > Select Access Point Profile

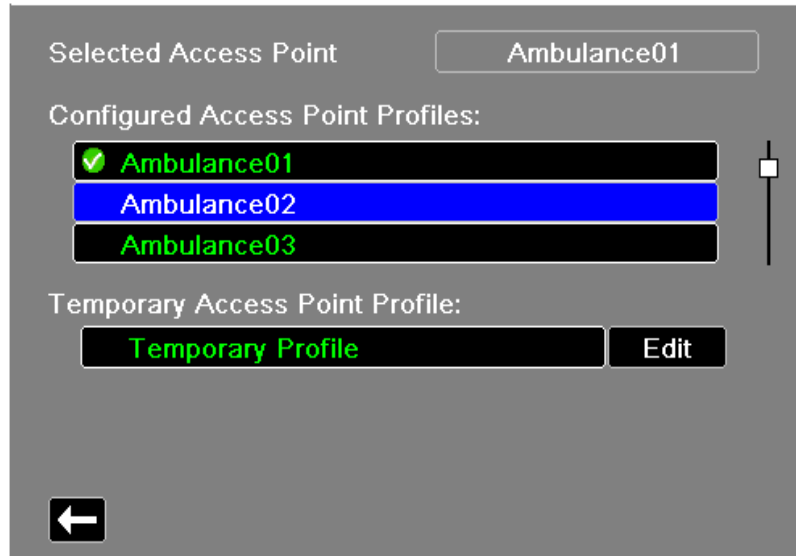


2. Navigate to and select a profile from the Configured Access Point Profiles list. A green check mark appears to show that the profile has been selected.
3. Press the back arrow (←) to return to the Wireless menu.

Creating a Temporary Access Point Profile

When the unit has been moved to a temporary location and requires wireless access, you can create a Temporary Access Point Profile. In the wireless menu, use the navigation keys to highlight and select **WiFi Access Point**. You can now view preconfigured Access Point Profiles.

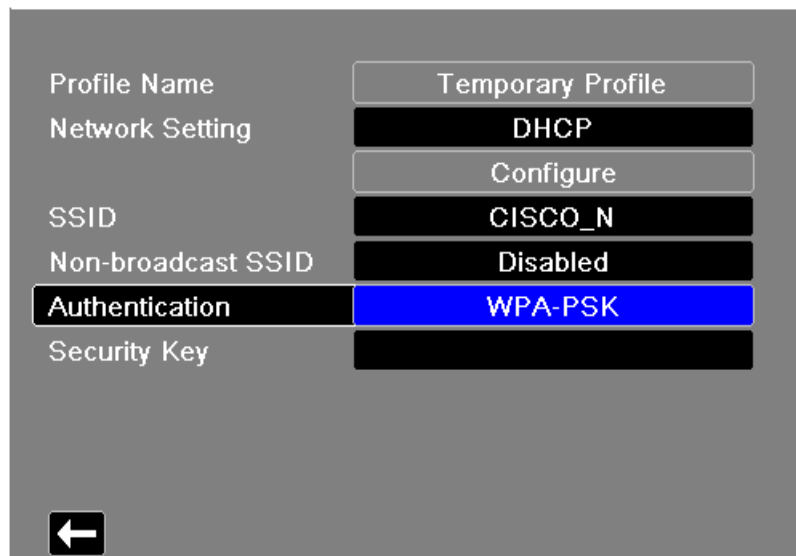
Wireless > Select Access Point Profile



Use the navigation keys to highlight and select **Temporary Profile**. A green check mark appears to show that the profile has been selected.

To edit the profile, use the navigation keys to highlight and select **Edit**. The unit displays the Edit AP Profile menu.

Wireless > Select Access Point Profile > Edit AP Profile



Profile Name

The profile name is “Temporary Profile” and cannot be changed.

Network Setting

Use the navigation keys to select either DHCP or Static IP. If you select Static IP, use the numeric keypad to enter values for the IP Address, Subnet Mask, Default Gateway, Preferred DNS Server, and Alternate DNS Server.

Select Access Point Profile > Edit AP Profile > Configure Static IP

The screenshot shows a configuration screen with a central numeric keypad overlay. The keypad has buttons for digits 0-9, a decimal point, and function buttons: SAVE, Clear, Backspace, and Cancel. The background shows fields for IP Address, Subnet Mask, Default Gateway, Preferred DNS Server, and Alternate DNS Server, each with a value of 0. A back arrow is visible in the bottom left corner.

SSID

Use the alphabetical keypad to enter the SSID name. Press **SAVE** to save changes and return to the Temporary Profile menu; press **Cancel** to return to the Temporary Profile menu without saving changes.

The screenshot shows an SSID configuration screen. At the top, the SSID name 'CiscoN' is displayed in a black box. Below it is an alphabetical keypad with letters A-Z, a Backspace key, and a Clear key. At the bottom, there are buttons for SAVE and Cancel. The keypad also includes numeric keys and symbols like #, *, /, @, &, ', -, \, !, ?, \$, %, +, ^, =, ~, ;, ", <, >, (,).

Non-broadcast SSID

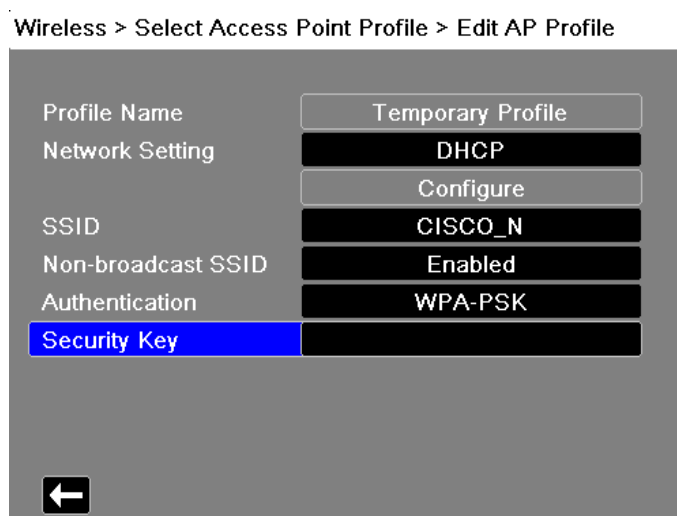
Use the navigation keys to enable or disable non-broadcast or hidden SSIDs. This must be set to Enabled to allow the Propaq MD to connect to a WiFi network that is configured not to broadcast its SSID.

Authentication

Use the navigation keys to select the authentication type. The unit supports three types of Wi-Fi authentication:

- WPA-PSK (Wi-Fi Protected Access, Pre-shared key)
- WPA2-PSK (Wi-Fi Protected Access II, Pre-shared key)
- Enterprise

For WPA-PSK or WPA2-PSK, you are required to enter a security key (8-64 characters).

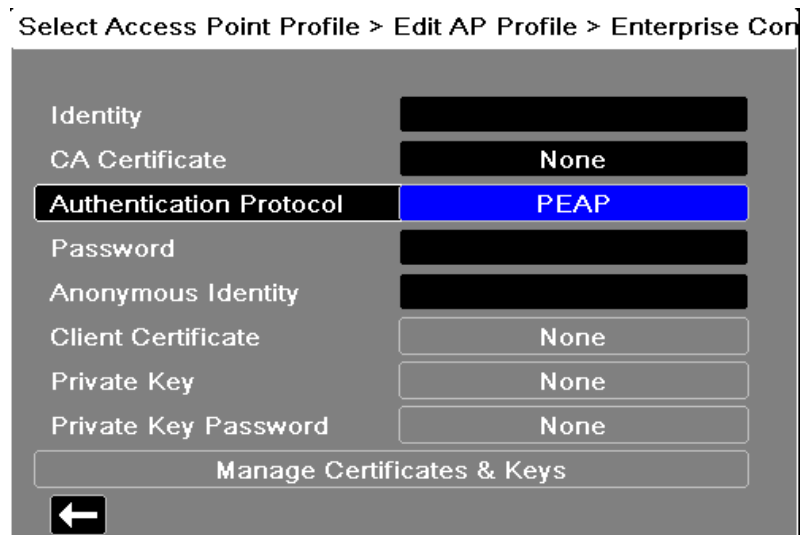


Use the alphabetical keypad to enter the security key. Press **SAVE** to save changes and return to the Temporary Profile menu; press **Cancel** to return to the Temporary Profile menu without saving changes.



Configuring Enterprise Authentication

Further configuration is required for Enterprise; use the navigation keys to select **Enterprise Settings Configure**. You will be asked for the Identity, CA certificate (optional for PEAP), and Authentication Protocol (TLS or PEAP). Some fields will be greyed out, depending on the Authentication Protocol that you select.



PEAP (Protected Extensible Authentication Protocol): If PEAP (Protected Extensible Authentication Protocol) is selected, you must enter the Password corresponding to the Identity entered. If the network requires it, you may enter an Anonymous Identity. The CA certificate is also optional. Other options on the screen will be greyed out.

Note: The Propaq MD unit only supports PEAPv0/v1 + MSCHAPV2.

TLS (Transport Layer Security): If TLS is selected, you must select a Client Certificate and enter the Private Key Password corresponding to the private key in the Certificate file. Other options on the screen will be greyed out.

For all certificates and keys, you can choose from a list of pre-loaded files. See page 22 below for information on managing certificates and keys in the Supervisor menu.

Press the back arrow (⬅️) to return to editing the Temporary Profile.

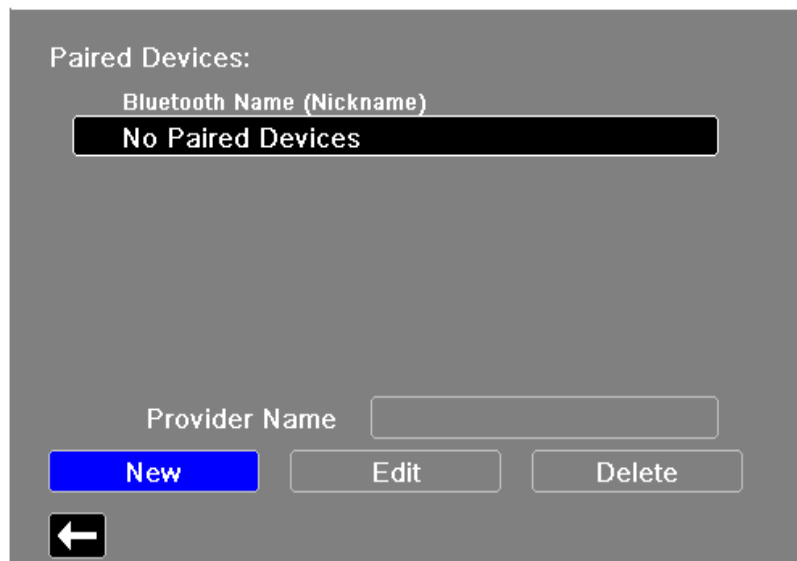
When you are done editing the Temporary Profile menu, press the back arrow (⬅️) to exit the wireless menu.

Note: The selected Temporary Profile remains selected until a different access point profile is chosen. You do not need to re-enter the configuration information.

Bluetooth Device Pairing

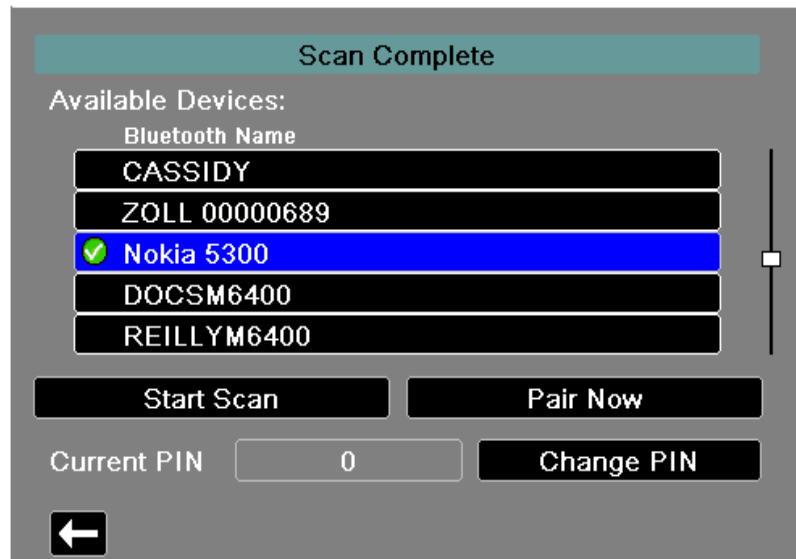
In the wireless menu, use the navigation keys to highlight and select **View/Configure Paired Devices**. You can now view paired Bluetooth devices. To pair a new device, use the navigation keys and select **New**.

Wireless > Configure Bluetooth



The unit will then scan for nearby Bluetooth devices that are in discoverable mode. Use the navigation keys to select the desired device; a green check mark indicates which device has been selected.

Wireless > Configure Bluetooth > Pair New Device

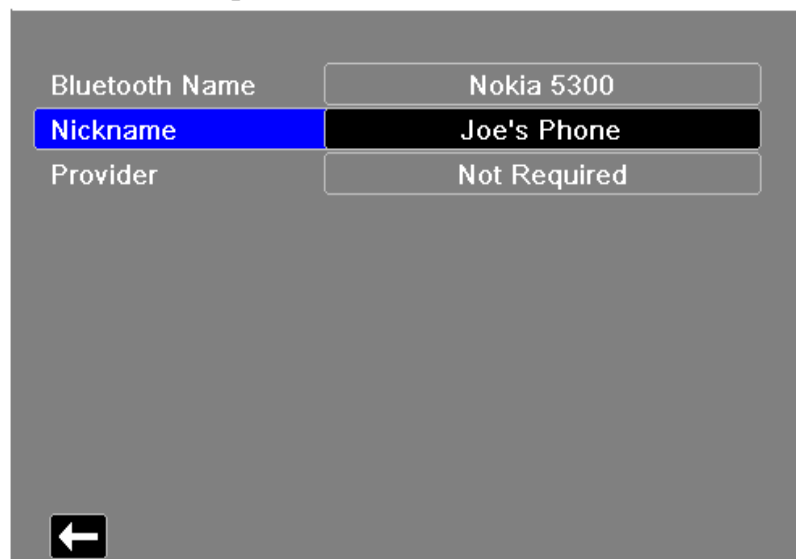


Select **Pair Now** to pair the device. On your Bluetooth device, accept the pairing request and enter the PIN, if prompted.

The unit then returns to the list of paired devices.

You can then edit the settings of the paired device, and give the device an optional nickname or provider. Press the back arrow (←) to return to the list of paired devices.

Wireless > Configure Bluetooth > Edit

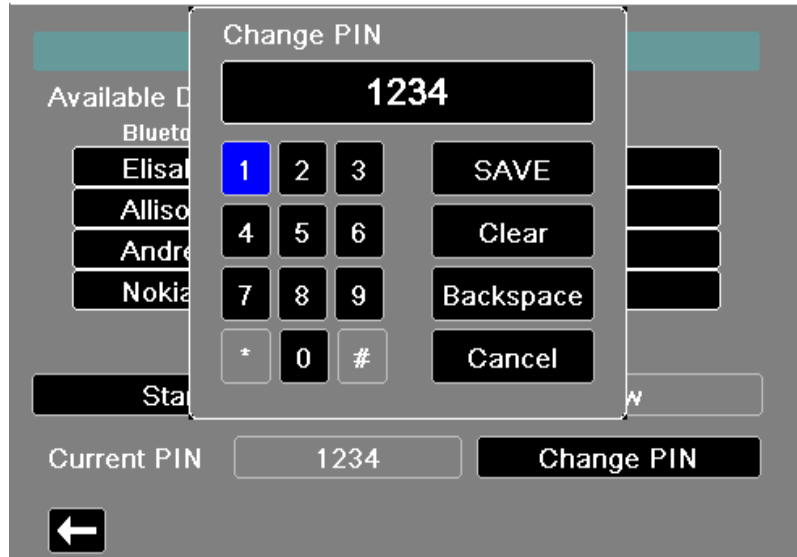


Note: Use Bluetooth devices with DUN or PAN-NAP profiles only. Contact your local ZOLL Medical Corporation sales representative for a list of approved devices.

Changing the PIN

It may be necessary to change the PIN on the Propaq MD unit; check your device's documentation. To change the PIN, select **Change Pin** in the Bluetooth menu, then use the numerical keypad to enter the desired PIN.

Wireless > Configure Bluetooth > Pair New Device



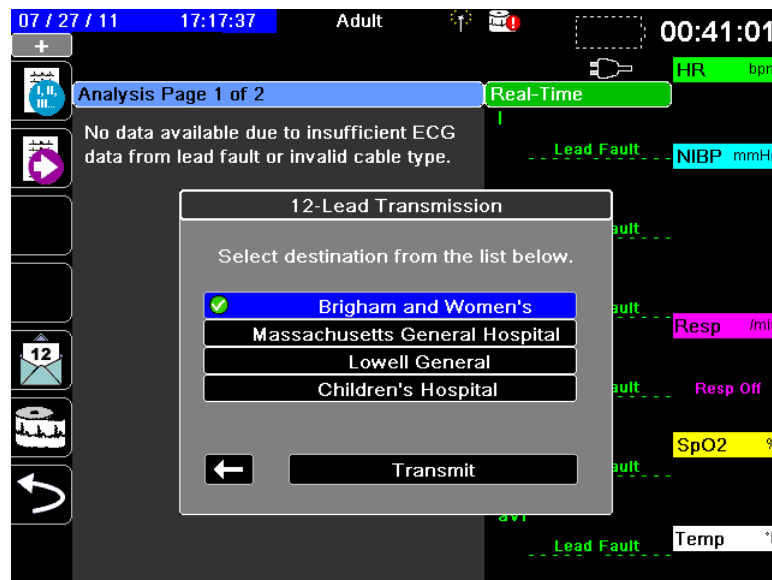
When finished pairing all Bluetooth devices, press the back arrow (←) to return the wireless menu. Press the arrow again to exit to the main screen.

Sending a 12-Lead Report

When a 12-lead report has been acquired or a previously acquired 12-lead has been selected for review, the Propaq MD unit prepares the report for transmission. When this is complete, the Transmit quick access key (12) displays.

To send a 12-lead report to a preconfigured distribution list:

1. Press the **12-lead** quick access key (12).
2. If desired, press the **Snapshot** button (10) to take a 12-lead snapshot (see Chapter 14, "12-Lead ECG Interpretive Analysis" for more information about acquiring 12-lead data).
3. Press the **12-lead review next** quick access key (11). A list of snapshots appears; select the desired snapshot.
4. Press (12). A list of preconfigured distribution lists appears.



Use the navigation keys to highlight and select the desired distribution list. A green check box indicates the selected list. When a destination has been selected, the **Transmit** button is enabled.

5. Press **Transmit** to initiate the 12-lead transmission.



While the transmission is in process, the green LED on top of the unit is illuminated and a message appears on the screen.

Sending Disclosure Logs





For systems with a Disclosure log server configured, the Propaq MD unit allows you to send patient disclosure logs for up to 15 cases at one time to a remote server through a wireless connection.



Note: The Propaq MD unit automatically cancels any case disclosure log transmissions when defibrillation is activated.

To transfer disclosure log data:

1. From the Primary Display window press the **Log** button () then press the **Disclosure Log Transfer** quick access key (). The Close Current Case? dialog box displays.
2. Specify whether or not to include the current case in the transfer by navigating to and selecting:
 - **Close Case** if you would like to include the disclosure logs for the current case in the transfer. When you select **Close Case**, the Propaq MD closes the current case and generates a new case for the current patient. That way Pacing, Defib, and AED parameter settings for the current patient remain intact following the transfer.
 - **Continue** button to continue the transfer without the current case.

The **Case Selection** dialog box displays with a list of up to 150 most recent cases.

3. Use the navigation keys to select **Select Cases** then press the **Select** button (). The highlight moves to the list of available cases to transfer.
4. Select up to 15 cases to include in the transfer by using the up and down navigation arrows to highlight a case then pressing the **Select** button (). A case is selected for inclusion in the disclosure log transfer when a check mark displays to the left of the case. The **Number of Cases Selected** field indicates the number of cases currently selected.
5. When you are done selecting cases, press the **Home/Display** button (). The highlight moves to the **Transfer** key.
6. With the **Transfer** key highlighted, press the **Select** button (). The Disclosure Log Transfer dialog displays indicating the transfer progress.

If the Disclosure Log Transfer Failure dialog box displays, use the navigation keys to select **Retry** then press the **Select** button (). The Propaq MD continues the transfer from the case that failed. Otherwise, if you would like to end the transfer use the navigation keys to select **Cancel** then press the **Select** button () to return to the Primary Display window.

7. When the Disclosure Log Transfer Complete dialog box displays select **OK** to return to the Primary Display window.

Supervisor Communications Menu

Overview

The Communications menu is located in the Supervisor Setup menu. The Supervisor function is restricted and requires password access.




In the Communications menu, you can setup:

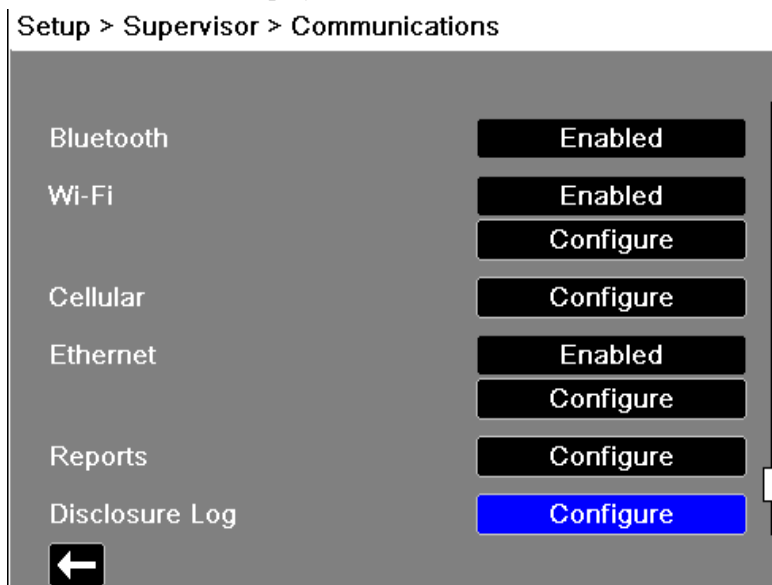
- WiFi access points
- Bluetooth pairings (DUN or PAN-NAP profiles only)
- Cellular provider information for use with USB cellular modems
- An Ethernet connection
- 12-lead report settings and set up distribution lists for 12-lead and full disclosure reports
- Disclosure Log transfer settings
- Clock Synchronization settings

Note: Communications setup is not available in AED mode.

Accessing the Communications Menu

To access the Communications menu:

1. Press the **More** quick access key (.
2. Press the **Setup** quick access key (). Use the navigation keys to scroll down to **Supervisor**. Press .
3. Enter the password. The Supervisor menu appears.
4. Use the navigation keys to highlight and select **Communications**. The options for Communications are displayed.



Wireless

Use the navigation keys to enable or disable this function. When disabled, all wireless capabilities are disabled in the Propaq MD unit.

Bluetooth

Use the navigation keys to enable or disable this function. When disabled, all Bluetooth capabilities are disabled in the Propaq MD unit.

Wi-Fi

Use the navigation keys to enable or disable this function, and to configure access point profiles (see “WiFi Access Point Profiles” on page 22-17). When disabled, all internal Wi-Fi capabilities are disabled in the Propaq MD unit.

Cellular

Use the navigation keys to configure USB cellular modem or Bluetooth devices (see “Setting up Cellular Communications” on page 22-24).

Ethernet

Use the navigation keys to enable or disable Ethernet capability. See “Setting up an Ethernet Connection” on page 22-29 below for configuring your Ethernet connection.

12-Lead Reports

Storage and management of 12-lead reports and full disclosure case files on the Propaq MD unit can be managed from third-party software such as ZOLL RescueNet. In this menu you can configure the ZOLL server, and view or update distribution lists (see “Configuring 12-Lead Report Transmissions” on page 22-30).

Disclosure Log

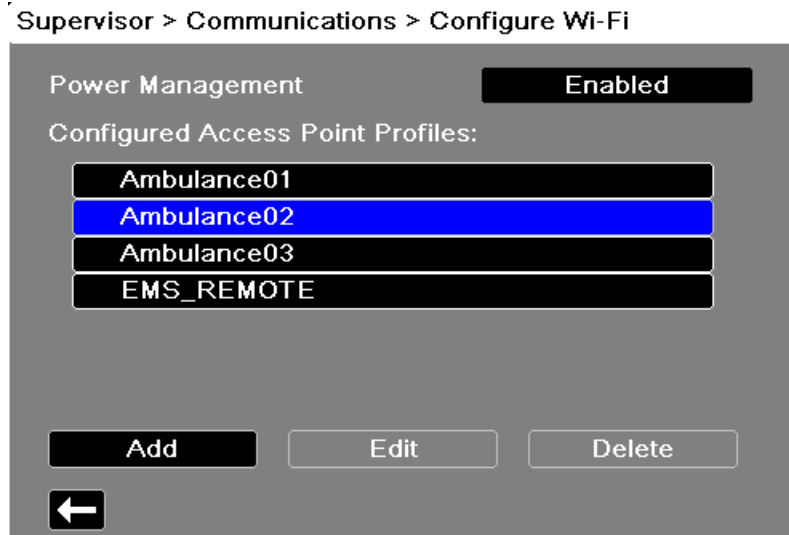
The Propaq MD unit allows you to send the Disclosure Logs and audio for up to 15 cases at one time to a remote server. Use the Disclosure Log menu to configure the server to which to send the log data (see “Configuring Disclosure Log Transmissions” on page 22-31).

Clock Sync

Use the navigation keys to configure Clock Synchronization. The Clock Synchronization feature allows you to synchronize the Propaq MD unit’s internal real time clock to an external reference time source using Simple Network Time Protocol (see “Configuring Clock Synchronization” on page 22-32).

WiFi Access Point Profiles

To select and modify Wi-Fi Access Point Profiles, use the navigation keys to highlight and select **Configure Wi-Fi**.



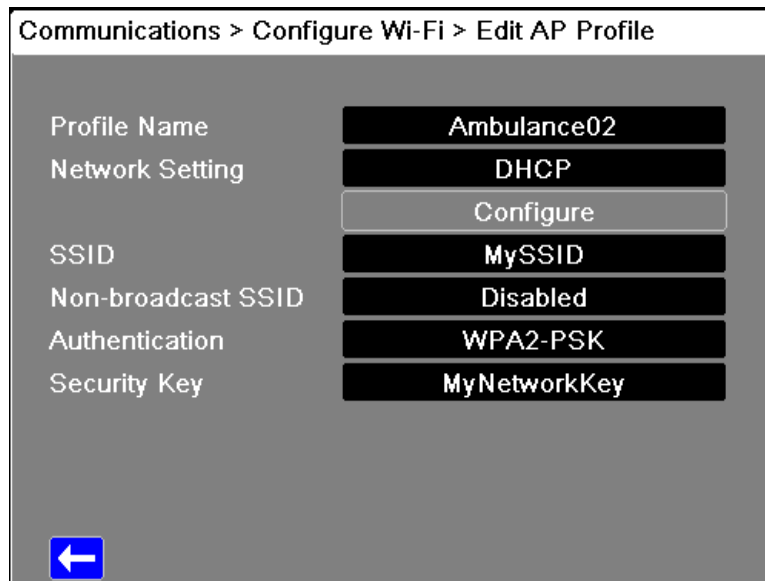
A green check mark indicates the selected access point. Use the navigation keys to select a different profile, or to add, edit or delete other profiles.

Note: Selecting a profile in this list allows you to edit or delete the profile. It does not make a profile the active Wi-Fi profile selection. See “Selecting a Pre-Configured Access Point Profile” on page 22-5 for information on making a Wi-Fi profile active.

The Power Management option allows you to enable or disable Wi-Fi power management. The Power Management option is enabled by default.

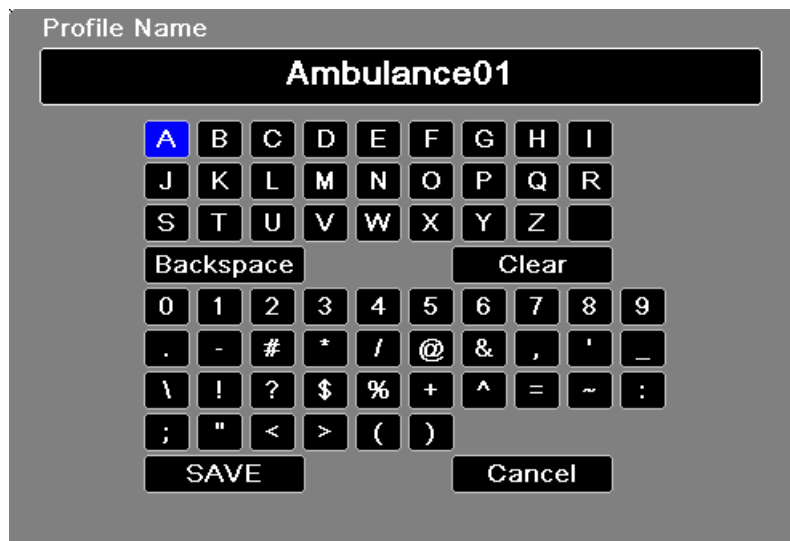
To add a new Access Point Profile:

Use the navigation keys to highlight and select **Add**. You can enter the type of network setting, profile name, SSID, authentication, and security key.



Profile Name

Use the alphabetical keypad to enter the profile name. Press **SAVE** to save changes and return to the WiFi configuration menu; press **Cancel** to return to the WiFi configuration menu without saving changes.



Network Setting

Use the navigation keys to select either DHCP or Static IP. If you select Static IP, use the numeric keypad to enter values for the IP Address, Subnet Mask, Default Gateway, Preferred DNS Server, and Alternate DNS Server.

Configure WiFi > Edit AP Profile > Configure Static IP

The screenshot shows a configuration menu with a numeric keypad overlay. The keypad has the following layout:

7	8	9	SAVE
4	5	6	Clear
1	2	3	Backspace
0	.		Cancel

The background menu items are partially visible: IP Address, Subnet Ma, Default Ga, Preferred D, and Alternate D. Each item has a corresponding input field with a '0' value. A back arrow is located at the bottom left of the screen.

SSID

Use the alphabetical keypad to enter the SSID name. Press **SAVE** to save changes and return to the WiFi configuration menu; press **Cancel** to return to the WiFi configuration menu without saving changes.

The screenshot shows the SSID configuration screen with the text 'MySSID' entered in the input field. The keypad layout is as follows:

A	B	C	D	E	F	G	H	I	
J	K	L	M	N	O	P	Q	R	
S	T	U	V	W	X	Y	Z		
Backspace						Clear			
0	1	2	3	4	5	6	7	8	9
.	-	#	*	/	@	&	,	'	_
\	!	?	\$	%	+	^	=	~	:
;	"	<	>	()				
	SAVE						Cancel		

Non-broadcast SSID

Use the navigation keys to enable or disable non-broadcast or hidden SSIDs. This must be set to Enabled to allow the Propaq MD to connect to a WiFi network that is configured not to broadcast its SSID.

Authentication Protocol

Use the navigation keys to select the authentication type. The unit supports three types of Wi-Fi authentication:

- WPA-PSK (Wi-Fi Protected Access, Pre-shared key)
- WPA2-PSK (Wi-Fi Protected Access II, Pre-shared key)
- Enterprise

For WPA-PSK or WPA2-PSK, you are required to enter a security key (8-64 characters).

Communications > Configure Wi-Fi > Edit AP Profile

Profile Name	RSERIES
Network Setting	DHCP
	Configure
SSID	
Non-broadcast SSID	Disabled
Authentication	WPA-PSK
Security Key	

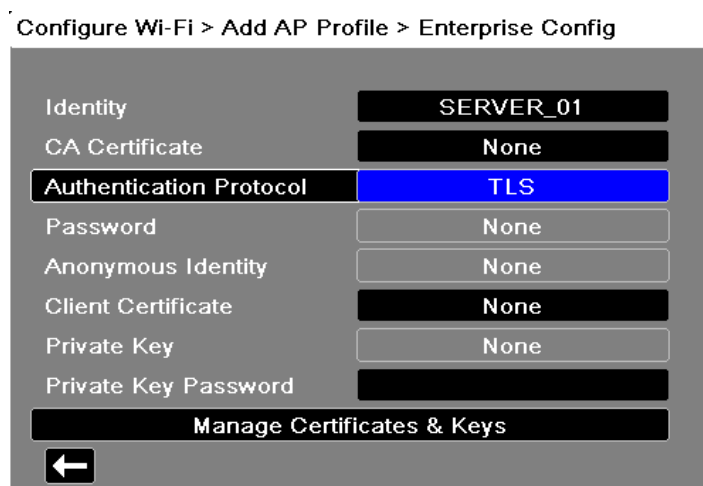
←

Use the alphabetical keypad to enter the security key. Press **SAVE** to save changes and return to the Temporary Profile menu; press **Cancel** to return to the Temporary Profile menu without saving changes.



Configuring Enterprise authentication

Further configuration is required for Enterprise; use the navigation keys to select **Enterprise Settings Configure**. You will be asked for the Identity, CA certificate (optional for PEAP), and Authentication Protocol (TLS or PEAP). Some fields will be greyed out, depending on the Authentication Protocol that you select.



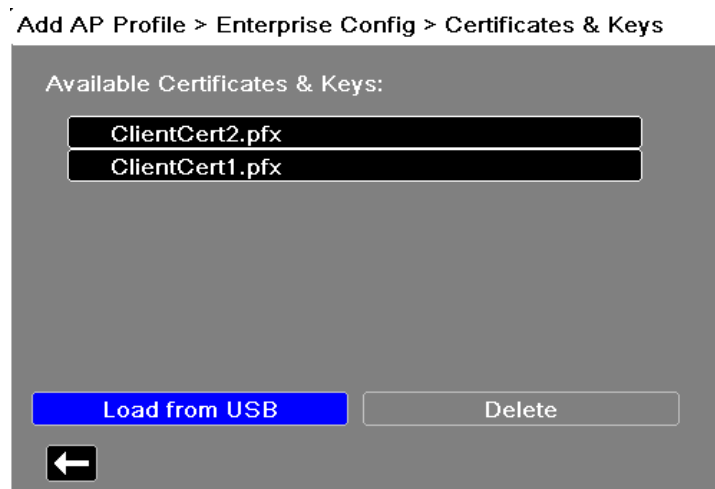
PEAP (Protected Extensible Authentication Protocol): If PEAP (Protected Extensible Authentication Protocol) is selected, you must enter the Password corresponding to the Identity entered. If the network requires it, you may enter an Anonymous Identity. The CA certificate is also optional. Other options on the screen will be greyed out.

Note: The Propaq MD unit only supports PEAPv0/v1 + MSCHAPV2.

TLS (Transport Layer Security): If TLS is selected, you must select a Client Certificate and enter the Private Key Password corresponding to the private key in the Certificate file. Other options on the screen will be greyed out.

For all certificates and keys, you can choose from a list of pre-loaded files.

To load a new certificate from a USB device, select **Manage Certificates & Keys**. A list of existing certificates will appear.

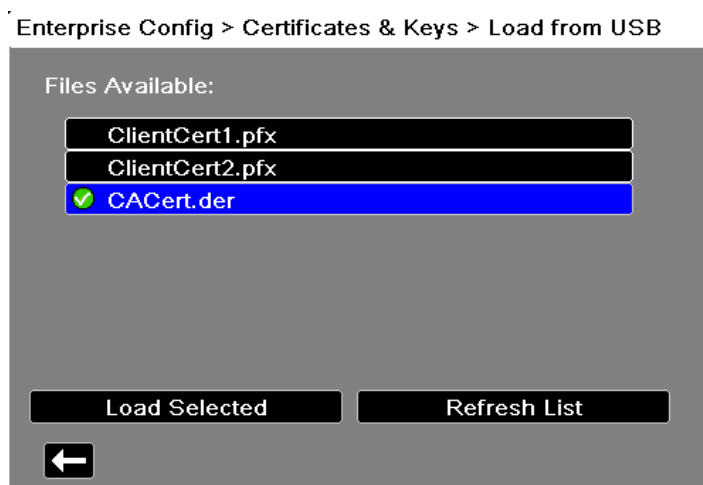


Select **Load from USB**. A list of files on the USB device will appear.

Filenames can only be 24 characters long. If the files on the USB device are more than 24 characters, then they will not appear on the Propaq MD unit screen.

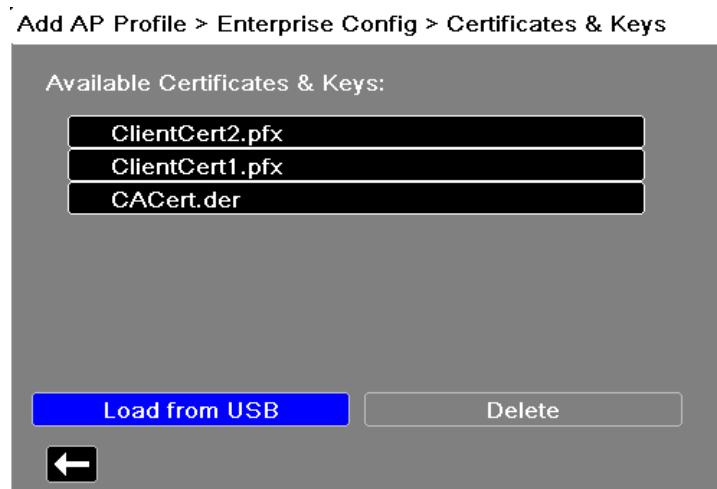
Note: The Propaq MD unit only supports PFX format client certificates.

To load a file, use the arrow keys to select the desired file. Only one file can be selected at a time.



Select **Load Selected**. If a new USB device has been inserted, select **Refresh List**.

Note: No message will appear to indicate that the file has loaded. After pressing **Load Selected**, press the back arrow (←) to view the list of all currently loaded certificates and keys.



Press ← to return to the Enterprise Wi-Fi Configuration menu, and ← again to return to the Add Access Point Profile menu.

When finished editing your WiFi profile, press the back arrow (←) to return to return to the list of configured access point profiles. From this menu you can also edit or delete existing profiles.

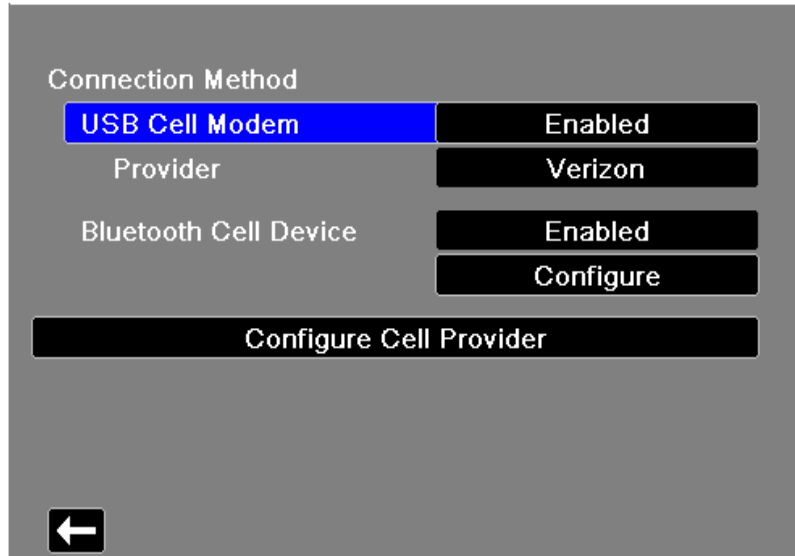
After deleting a file, be sure to review the defined Wi-Fi profiles and update any which referred to the deleted file.

Press ← to return to the Communications menu.

Setting up Cellular Communications

You can configure your USB cellular modem or Bluetooth device to work with the Propaq MD unit. Under the Communications menu, select **Cellular Configure**. The Cellular menu appears.

Supervisor > Communications > Cellular



You can use the arrow keys to enable or disable all cellular functions, and configure your cell phone provider information.

Configuring Cell Phone Provider Information

You can create up to three cell phone providers. Use the arrow keys to enter information about your cell phone provider:

- **Provider Name**

Provider name is an identifier you choose to refer to this cell phone provider.

- **Call Number**

Call number is an access number sometime referred to as a Dial String.

- **Account Name and Password**

Some providers require an account name and password. If your provider does not require these fields, leave them blank.

Communications > Cellular > Configure Cell Provider

Configured Cell Providers:

Provider Name	
	T Mobile
	✓ Verizon
Call Number	#777
Account Name	
Password	

Add Edit Delete

←

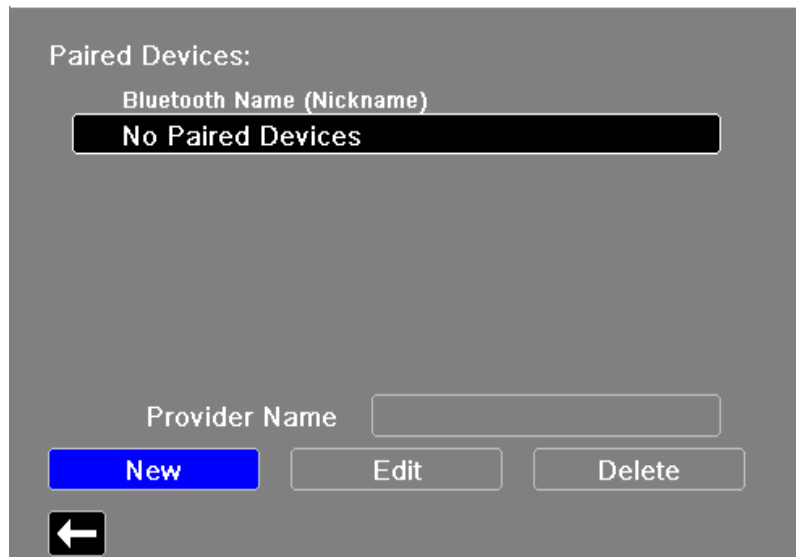
Configuring and Pairing Bluetooth Devices

Bluetooth devices can also be paired from the main wireless menu, which does not require a password (see “Bluetooth Device Pairing” on page 22-10).

To pair Bluetooth devices, select **Bluetooth Cell Device Configure** in the Cellular menu.

To pair a new device, use the navigation keys and select **New**.

Communications > Cellular > Configure Bluetooth



The unit will then scan for nearby Bluetooth devices that are in discoverable mode. Use the navigation keys to select the desired device; a green check mark indicates which device has been selected.

Cellular > Configure Bluetooth > Pair New Device



Select **Pair Now** to pair the device. On your Bluetooth device, accept the pairing request and enter the PIN, if prompted.

The unit then returns to the list of paired devices.

Cellular > Configure Bluetooth > Pair New Device

Pairing..

Available Devices:

Bluetooth Name

DASCOLIM4600

ZOLL-2311M01196

Start Scan

Pair Now

Current PIN 1234

Change PIN

←

You can then edit the settings of the paired device, and give the device an optional nickname or set the provider. A provider is not required for Bluetooth devices using the PAN-NAP profile. Press the back arrow (←) to return to the list of paired devices.

Communications > Cellular > Configure Bluetooth

Paired Devices:

Bluetooth Name (Nickname)

Nokia 5300 (Nokia 5300)

Provider Name Not Required

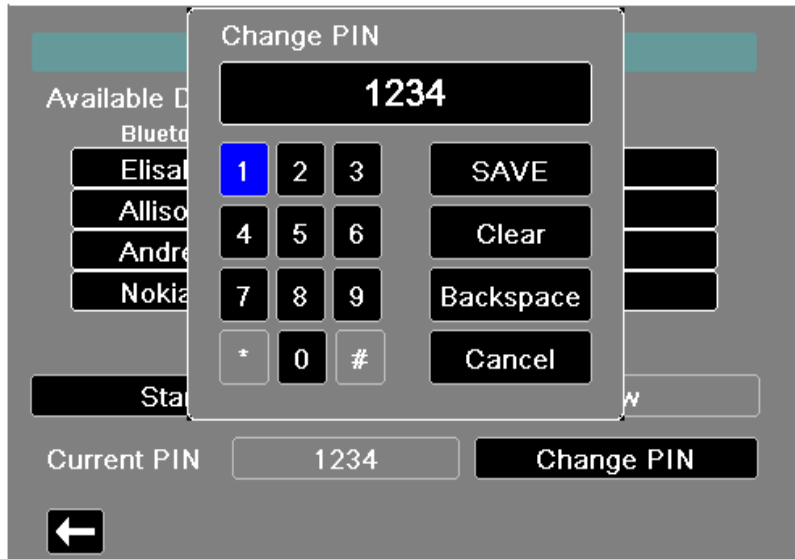
New Edit Delete

←

Note: Use Bluetooth devices with DUN or PAN-NAP profiles only. Not all cellular phones transmit reliably; contact your local ZOLL Medical Corporation sales representative for a list of approved devices.

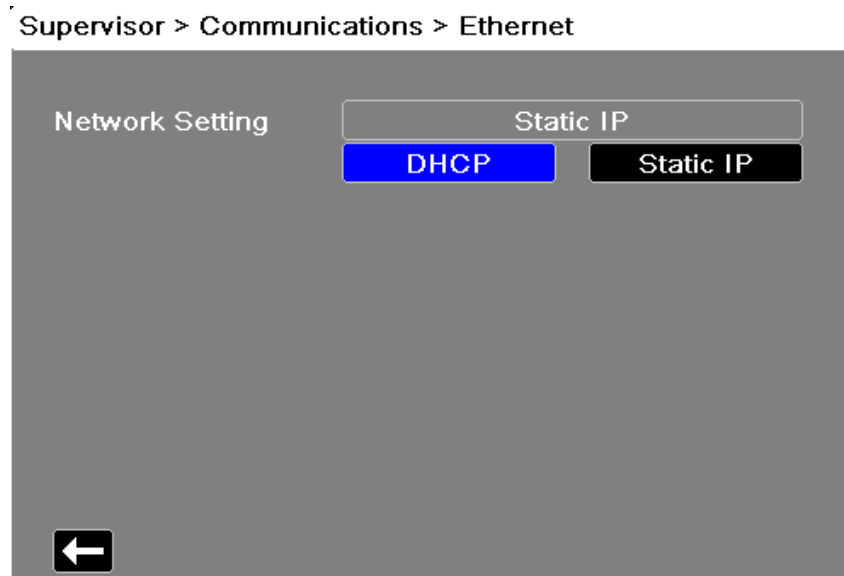
Changing the PIN: It may be necessary to change the PIN on the Propaq MD unit; check your device's documentation. To change the PIN, select **Change Pin** in the Pair New Device menu, then use the numerical keypad to enter the desired PIN.

Cellular > Configure Bluetooth > Pair New Device

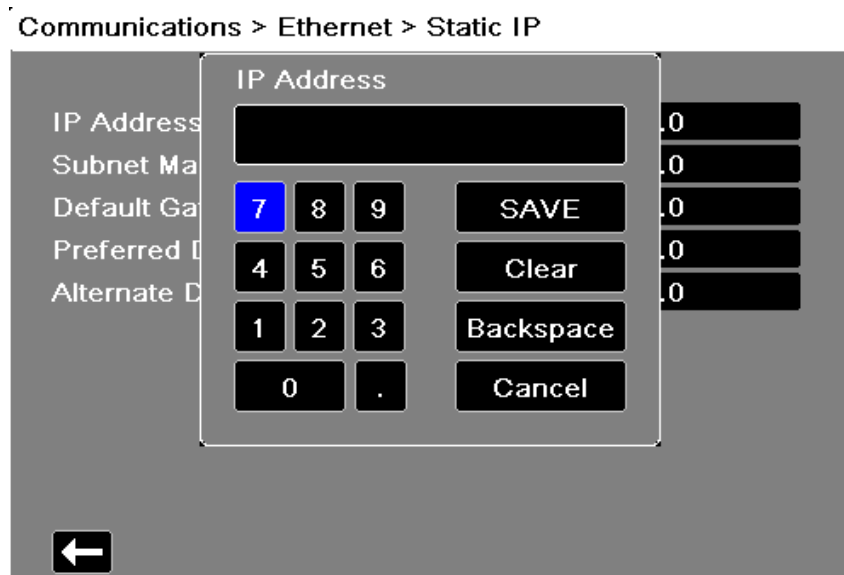


Setting up an Ethernet Connection

You can use an Ethernet adapter to transfer data to a PC via an Ethernet cable. In the Communications menu, select **Ethernet Configure**.



Use the navigation keys to select either DHCP or Static IP. If you select Static IP, use the numeric keypad to enter values for the IP Address, Subnet Mask, Default Gateway, Preferred DNS Server, and Alternate DNS Server.



Configuring 12-Lead Report Transmissions

The Propaq MD unit can send 12-lead reports to the ZOLL RescueNet software. Distribution List entries defined in your RescueNet account specify possible report destinations, each of which consists of one or many recipients such as email addresses and fax machines. You must have a RescueNet account set up before you can complete configuration of the Propaq MD device.

In the Communications menu, select **Reports Configure**.

The screenshot shows a configuration screen titled "Supervisor > Communications > Reports". It contains several input fields and buttons:

Server DNS Name	12lsubsvc.zollonline.com
Port	443
Password	MYPASSWORD
Customer ID	31115897

Below the input fields are two buttons: "View Distribution List" and "Update Distribution List". A back arrow button is located in the bottom left corner.

Enter your RescueNet Customer ID and Password in the fields provided.

Before you can transmit 12-lead reports, you must download the current Distribution List for your account from the RescueNet server. If you have already configured your wireless preferences, you can use the **Update Distribution List** button to complete the download.

The Propaq MD retains the current Distribution List until a new one is downloaded. If you modify the Distribution List entries using RescueNet, you should download a new copy to the Propaq MD device.

Configuring Disclosure Log Transmissions

The Propaq MD unit continuously stores information in a full disclosure case log for monitored patients. The Propaq MD unit can maintain up to 150 full disclosure cases that contain:

- treatment events
- trends
- ECG and other continuous waveforms
- monitoring and event snapshots
- 12-lead snapshots and analysis.

For systems with a Disclosure Log server configured, the Propaq MD unit allows you to wirelessly transmit the full Disclosure case logs and audio for up to 15 cases to a remote server for subsequent retrieval. Use the Supervisor>Communications>Disclosure Log menu to configure the remote server to which to send the disclosure log case data.

To configure the remote server:

1. Under the Communications menu, select **Disclosure Log >Configure**. The Disclosure Log menu displays.

Supervisor > Communications > Disclosure Log

Server DNS Name	dxsvc.zollonline.com
Port	443
Password	
Customer ID	1234

←

2. In the **Server DNS Name** field, enter the host name of the remote server to which to send the Log data.
3. Enter the **Port** to be used to connect to the server.
4. Enter your associated **Password** and **Customer ID** in the fields provided.
5. When you are done entering data, press the back arrow (←) to return to the Supervisor>Communications menu or press or the **Home/Display** button (⏪) to Primary Display window.

Configuring Clock Synchronization

The Clock Synchronization feature allows you to synchronize the Propaq MD unit's internal real time clock to an external reference time source using Simple Network Time Protocol (SNTP). SNTP servers provide Coordinated Universal Time (UTC) which is the primary time standard by which the world regulates clocks and time. In order to convert this standard time to the local time, the Propaq MD allows you to configure a timezone offset. A timezone offset is the difference in hours and quarter-hours from UTC time for a particular locale. The timezone offset is a positive number if the local timezone is ahead of UTC and a negative number if it is behind. Additionally, for locations that observe Daylight Saving Time, the Propaq MD provides a setting that, when set to On, immediately applies an additional 1-hour positive offset from UTC. The supervisor sets the initial value and the operator may subsequently toggle Daylight Saving Time on or off as necessary on the Set Date and Time screen (see "Setting the Date and Time" on page 2-21).

When Clock Sync is enabled and a network connection is available, the Propaq MD unit automatically acquires a reference time from the SNTP server and converts the reference time to local time. The Propaq MD will acquire a reference time from the SNTP server if no reference time has been acquired since the unit was powered on or the Clock Sync configuration settings have been changed. To ensure that the real time clock never changes during patient treatments, the Propaq MD will make adjustments to its clock, if necessary, after the unit has been off for at least two minutes and prior to the start of a new case.

When Clock Sync is enabled, you can see the time of the last synchronization on the Set Date and Time screen. The Propaq MD also provides the message *Clock Synchronization Failed* when an attempt at synchronization fails after the SNTP server settings have changed or if there has been no successful synchronization for 1 week or more. See "Setting the Date and Time" on page 2-21 for information on using the Set Date and Time screen.

To configure clock synchronization:

1. Under the Communications menu, select **Clock Sync > Configure**. The Clock Synchronization menu displays.

Supervisor > Communications > Clock Sync	
Clock Sync	SNTP
Time Server Name	TIME.EXAMPLE.COM
Time Server Port	123
Daylight Saving Time	Off
Time Zone Offset Hours	00
Time Zone Offset Mins.	00

2. In the **Clock Sync** field, specify whether or not to synchronize the Propaq MD internal real time clock to an external time source.
 - Select **SNTP** if you would like to synchronize the Propaq MD clock to an external time source.
 - Select **None** (default) if you do not wish to synchronize the Propaq MD internal real time clock to an external source.
3. In the **Time Server Name** field, specify the time server to use for clock synchronization by either entering the host name or an IPv4 address for the server.
4. In the **Time Server Port** field, enter a numeric UDP port number for connecting to the external server. The default is 123.
5. In the Daylight Saving Time field, indicate whether to use Daylight Saving Time or not by selecting **On** or **Off** (default) as appropriate. Adjustments to Daylight Saving Time take effect immediately and must be manually adjusted at every transition between Standard Time and Daylight Saving Time. The Daylight Saving Time offset is zero if Daylight Saving Time is set to **Off** and 60 minutes if Daylight Saving Time is set to **On**.

Note: UTC time is a constant reference time. It does not change to reflect Daylight Saving Time or Summer Time. The Daylight Saving Time field allows you to accommodate locales that observe Daylight Saving Time or Summer Time. So, for example, UTC is 5 hours ahead of local time on the east coast of the United States during winter, but 4 hours ahead during summer.
6. Indicate the time zone offset value to use for your particular locale in the **Time Zone Offset Hours** (default 0) and **Time Zone Offset Mins.** (default 0) fields as appropriate.

When you are done entering data, press the back arrow to return to the Supervisor > Communications menu. When changes are made on the Clock Sync menu the Propaq MD attempts to synchronize its time if a network connection is available. To ensure the real time clock never changes during patient treatments, any necessary clock synchronization corrections will not occur, however, until the unit has been off for at least two minutes and prior to the start of a new case.



Communications System Messages

The Propaq MD unit may display one of the following status messages during the transmission:

System Message	Cause
<i>TRYING TO CONNECT TO NETWORK</i>	The unit is connecting to the network.
<i>TRANSMITTING</i>	The data transfer is in progress
<i>TRANSMISSION COMPLETE</i>	The data transfer is complete.
<i>TRANSMISSION FAILED</i>	<p>The data transfer has failed.</p> <p>To correct the problem, check the following:</p> <ul style="list-style-type: none">• Verify that wireless communications is enabled on your Propaq MD unit.• Verify that the WiFi settings are correct in the Communications setup menu.• Verify that the ZOLL server is configured correctly.• Verify that your cellular device is configured correctly.• Make sure that the Propaq MD unit is within range of the wireless server.

Transmission Status Icons

If you have attempted to transmit a snapshot or case disclosure logs, the snapshot list in the 12 Lead Review window or the case list in the Case Selection window, displays an icon to the left of the snapshot or case indicating the status of that transmission:

Icon	Transmission Status
	Indicates that a successful transmission has occurred.
	Indicates that <i>no</i> successful transmission has occurred.

Chapter 23

Printing

This chapter describes procedures for printing permanent records of pertinent patient care data and events.



Warning! To avoid risk of electrical shock, do not touch the patient and internal parts of the printer simultaneously while the printer door is open.

Printing Patient Data



The printing option allows you to print the following patient information:

- Waveforms
- Reports
- Trends

Note: A date that contains question marks (??/??/??) indicates that the Propaq MD was not able to determine the date and time on power up. Power cycling the unit may correct the problem. If the problem persists, set the date and time by highlighting the **Date and Time** display field and pressing **Select**.



Note: The Print quick access key () is highlighted with a blue background while the printer is printing. Pressing  when it is highlighted stops the current printer activity.

Printer Setup

To configure the printer functions, press the **More** quick access key () , press the **Setup** quick access key () , highlight **Printer**, and press **Select**. Use the navigation keys to select the desired print configuration. The Setup>Printer window contains the following print configuration options:


Print configuration	Options
Print Speed	25 mm or 50 mm per second
Print Number of Traces	1, 2, 3, or 4
Print Grid	On or Off
Print on Snapshot	On or Off
Print on Patient Alarm	On or Off
Print on NIBP	On or Off
Print on Trend	On or Off

Automatic Prints

You can print any following events by setting the monitor to print automatically in the Setup>Supervisor>Printer window. To do this, press () , then press () . Using the navigation buttons, select **Supervisor**, and then **Printer**.

- Defib/Pacer Events
- Event
- Treatment Snapshot
- Treatment Summary Snapshots

Printing Waveforms

You can print waveforms by pressing () . The Propaq MD unit will print the displayed waveforms as configured in the Number of Traces option. The Print Number of Traces option can be set to **1**, **2**, or **3**. Patient vital sign numerics are printed above the waveforms.

Note: Waveforms that have invalid data print a dashed line for that trace.

The ECG Waveform

ECG waveforms are printed on a grid with major divisions (dotted lines) every 5mm and minor divisions (single dots) every 1 mm. The ECG waveform is always printed if ECG is monitored.

The Invasive Pressure Waveform

Pressure waveforms are printed on a grid with major divisions (vertical dotted lines) every 5 mm, and the pressure scale grids are printed horizontally.

The SpO₂ Plethysmograph

The SpO₂ plethysmograph is printed with major divisions (vertical dotted lines) every 5 mm.

CO₂ Waveform

CO₂ waveforms are printed on a grid with major divisions (vertical dotted lines) every 5 mm, and the pressure scale grids are printed horizontally.

RESP Waveform

Respiration waveforms are printed with major divisions (vertical dotted lines) every 5 mm.

Printing Reports

Print on Snapshot

Prints snapshot, including numerics and waveform each time a snapshot is acquired.

Print on Patient Alarm

You can print a report each time an alarm occurs. This report is called the Print on Patient Alarm Report. The **Print on Patient Alarm** setting must be turned on in the Setup>Print window.

Print on NIBP




You can print the results of an NIBP measurement each time one occurs. This report is called the NIBP Ticket Report. The **Print on NIBP** setting must be turned on in the Setup>Print window.

Print on Trend

Prints numeric trend values each time a trend data snapshot is taken.

Printing Treatment Summary Report

To print a treatment summary report, do the following:

1. Press the **More** quick access key ()
2. Press the **Log** quick access key ()
3. Press the **Treatment Summary** quick access key (). The Treatment Summary window displays.
4. Use the navigation keys to highlight and select the treatment summary you want to print.

Note: The Treatment Summary Report that you selected has a check mark next to it.


5. Use the navigation keys to highlight and select **Print Treatment Summary**.

Printing Trends

Printed trends are useful for reviewing the patient's vital signs over the last several minutes to the last five hours. The Propaq MD unit enables you to print vital signs data at one selected time or a trend summary showing vital signs values acquired during the current case (up to the last 24 hours).


Printing Trend Summary

Follow the steps below:

1. Press the **Display/Home** button () to display the Trends window.
2. Use the navigation keys to highlight **Trends** field and press **Select**. The Trend Settings menu displays.
3. Highlight **Print Trend Summary** and press **Select**. The Trend Summary Report begins printing and **Print Summary** field changes to **Cancel Report**.
4. To cancel the report, highlight **Cancel Report** and press **Select**.



Printing Individual Trend Snapshots

Follow the steps below:

1. Press the **Display/Home** button () to display the Trends window.
2. Highlight the **Navigate here to scroll through trends** field at the bottom of the Trends window, then press **Select**.
3. Highlight **Print this Trend** and press **Select**. The trend snapshot begins printing.

Printing Trend Data for Current or Older Cases

You can print a trend summary for one or more cases by doing the following:

1. Press the **Log** quick access key () then press **Print Trends** (). The Trend Summary menu displays.
2. Use the navigation keys to select the case or cases you want to print.
3. Press **Select**. The case(s) appears with a check mark.
4. Highlight the **Print Trend Summary** field and press **Select**. The trend data for all the selected cases begins printing.

Chapter 24

Maintenance

Resuscitation equipment must be maintained to be ready for immediate use. To ensure the readiness and optimum working condition of the Propaq MD unit, you should perform the following inspections and tests daily or at each shift change.

In addition to the daily check, authorized personnel should complete performance and calibration testing at regularly scheduled intervals, which should not exceed one year.

A maintenance log is an important part of a successful maintenance program in which you record information on a regular basis. This allows for verification of necessary maintenance and for scheduling periodic requirements such as calibration and certification.

In accordance with the recommendations of the Defibrillator Working Group of the Food and Drug Administration, an operator's shift check list is included in this chapter, which you can copy for use as needed.

Daily/Shift Check Procedure

Inspection

Equipment and Accessories

- Ensure that the Propaq MD unit is clean (with no fluid spills) and free of visible damage.
- Inspect all cables, cords, and connectors for signs of damage or excessive wear (cuts in insulation, fraying, broken wires, dirty or bent connector pins). Replace if damaged.
- Inspect the battery, ECG patient cable, multifunction cable (MFC), OneStep cable, pulse oximetry sensor, blood pressure cuff, and hose and temperature sensors for signs of damage or excessive wear. Replace if damaged.
- Inspect the defibrillator paddles for damage or excessive wear. Check that paddle surfaces are clean and free of electrolyte gel or other contaminants. Verify that all paddle controls operate freely when pressed and released.
- Inspect the external AC adapter and its power cords for signs of damage. Replace if damaged.

Supplies

- Verify the presence, proper condition, and appropriate quantities of all disposable supplies (hands-free therapy electrodes, ECG monitoring electrodes, defibrillator gel, recorder paper, alcohol swabs, razors/scissors, etc.).
- Verify that two sets of hands-free therapy pads are available.
- Ensure that the therapy and monitoring electrodes are sealed within the packages and within the expiration dates printed on the packages.
- Open the recorder door on the left side of the Propaq MD unit and verify that an adequate supply of paper is available in the unit.

Batteries

- Verify that a charged battery is fully inserted into the battery compartment of the Propaq MD unit.
- Ensure that a fully charged spare battery pack is available.

Ready For Use Indicator

- Check the Ready For Use (RFU) indicator on the Propaq MD front panel. Verify that the RFU symbol is displayed.



If the RFU indicator is flashing or displaying the Do Not Use symbol, then either an equipment fault has been detected or the unit's battery is low or not properly installed. Install a fully charged battery in the unit and check the RFU indicator again. If the RFU indicator continues to flash or display the Do Not Use symbol, remove the unit from service and contact the appropriate technical personnel or the ZOLL Technical Service Department.

Defibrillator/Pacing Test with Hands-Free Therapy Electrodes

Note: If a low battery message appears during any of this testing, the battery is close to depletion and should be replaced or recharged.

Warning! Keep hands, fingers, and other conductive materials away from paddle electrode plates when discharging the defibrillator, or pacing.

	Function	Response
1	Connect the external AC adapter to a working AC outlet and to the Propaq MD rear panel.	Verify that the green Auxiliary Power LED illuminates on the Propaq MD front panel.
2	Insert a battery into the unit (if a battery is not already in the slot).	Verify that the Battery Charge LED on the Propaq MD front panel illuminates yellow. When the battery pack has been fully charged, the battery status indicator light is green.
3	Press the unit's power on switch.	Verify the unit issues two audio beeps and that the red, yellow, and green Visual Alarm indicators illuminate for 2 to 3 seconds. Note: The yellow LED may remain lit after the unit powers on. The Propaq MD unit performs a number of power on self tests. Verify that the unit displays <i>SELF TEST PASSED</i> . If the message <i>SELF TEST FAILED</i> appears on the display, contact the appropriate technical personnel or the ZOLL Technical Service Department.
4	Disconnect the external AC adapter from the Propaq MD rear panel.	Verify that the unit continues to operate without interruption on battery power and that the displayed battery icon indicates that a fully charged battery is installed. Verify that no error messages are displayed.
5	With no ECG cables attached to the unit, select Lead I, II, or III as the waveform display source.	Verify that a <i>LEAD FAULT</i> message displays in the waveform window.
6	Select Pads as the waveform display source and connect the multifunction cable to the unit. (Do not connect the test connector to the MFC.)	Verify that a <i>CHECK THERAPY ELECTRODES</i> message displays in the waveform window.
7	Connect the multi-function cable (MFC) to the test connector.	Verify that the <i>CHECK THERAPY ELECTRODES</i> message is replaced by a <i>SHORT DETECTED</i> message.
8	Press the Select Energy arrow (up or down).	Verify that the defibrillation window displays and the following message appears: <i>PADS SHORT DETECTED</i> <i>SELECT 30J TO TEST</i>

	Function	Response
9	Press the Select Energy arrow (up or down) to select 30 Joules on the Propaq MD unit.	Verify that the defibrillator window shows 30 J as the selected energy.
10	Press the Charge button on the front panel.	Verify that a periodic tone sounds while the defibrillator is charging. At the completion of the charge cycle, the tone is continuous. The charge time should be less than 7 seconds. Verify that the Shock button () on the front panel illuminates when the defibrillator is charged.
11	Press and hold  on the front panel until the unit discharges.	Verify that the defibrillator discharges and that a <i>DEFIB SHORT TEST PASSED</i> message displays. If the message <i>DEFIB SHORT TEST FAILED</i> displays, contact the appropriate technical personnel or the ZOLL Technical Service Department.
12	After the defibrillator display panel closes, press the Pacer button on the front panel to display the Pacer Settings dialog box.	Verify that the Pacer Settings dialog displays with the pacer status bar behind it.
13	Perform the following steps: <ul style="list-style-type: none"> • Set the Pacer mode to Fixed. • Set the Pacer Rate to 60 ppm. • Set the Output to 100 mA. • Select the Start Pacer button. 	Verify that the green pace indicator on the pacer status bar flashes once each second. Verify that pace markers are printed every 25 mm on the chart recorder printout. Note: If a printout does not automatically begin after starting the pacer, select the Print quick access key to start a continuous printout. Press the Print quick access key again to stop the printout.
14	Press the Pacer button on the front panel button again to close the Pacer Settings dialog box.	Verify that the pacer status bar indicates <i>PACING: SHORT DETECTED</i> . Verify that the green pace indicator continues to flash once each second. Verify that no pacer-related error messages display.
15	Disconnect the test connector from the MFC.	Verify that the pacer status bar displays: <i>PACING: CHECK THERAPY ELECTRODES</i>
16	Press the Pacer button on the front panel to display the Pacer Settings dialog. Select Turn Pacer Off to turn off the pacer.	Verify that the Pacer Settings dialog is closed and that the pacer status bar is removed from the display.
17	Reconnect the external AC Adapter to the Propaq MD rear panel.	Verify that the green Auxiliary Power indicator light on the Propaq MD front panel is illuminated.

Defibrillator Testing with External Paddles

Prior to testing external defibrillator paddles with the Propaq MD unit, complete the testing described in “Defibrillator/Pacing Test with Hands-Free Therapy Electrodes” on page 24-3.

Note: If a low battery message appears during any of this testing, the battery is close to depletion and should be replaced or recharged.

Warning! **Keep hands, fingers, and other conductive materials away from paddle electrode plates when discharging the defibrillator, or pacing.**

	Function	Response
1	Press the Propaq MD power switch to turn the unit on.	Verify that the unit displays the <i>SELF TEST PASSED</i> message.
2	Connect the MFC to the defibrillator and disconnect the patient end of the MFC from any attached accessory (paddles or test connector). Select Pads as the waveform display source.	Verify that a <i>CHECK THERAPY ELECTRODES</i> message displays in the waveform window
3	Connect the paddles set to the Propaq MD MFC cable. Do not place the paddles electrodes in contact with each other.	Verify that the <i>CHECK THERAPY ELECTRODES</i> message changes to <i>APPLY PADDLES TO PATIENT</i> .
4	Press the RECORDER ON/OFF button on the Sternum paddle.	Verify that the recorder begins printing.
5	Press the RECORDER ON/OFF button again.	Verify that the recorder stops printing.
6	Press the Apex and Sternum paddle electrodes together (face to face) maximizing the contact area between the electrodes.	Verify that the <i>APPLY PADDLES TO PATIENT</i> message changes to <i>SHORT DETECTED</i> .
7	Press the ENERGY SELECT (+) button on the Sternum paddle.	Verify that the defib window displays and the following message appears: <i>PADDLE SHORT DETECTED</i> <i>SELECT 30 J TO TEST</i>
8	Press the ENERGY SELECT (+) button again.	Verify that the selected energy increases to the next highest level.
9	Repeatedly press the ENERGY SELECT (-) button on the Sternum paddle until 30 Joules is selected.	Verify that the defibrillator window shows 30 J as the selected energy.
10	Press the CHARGE button on the Apex paddle. (Press the CHARGE button twice if the defibrillator window has disappeared.)	Verify that a periodic tone sounds while the defibrillator is charging. At the completion of the charge cycle, the tone is continuous. The charge time should be less than 7 seconds. Verify that the CHARGE light on the Apex handle illuminates when the defibrillator is charged and ready to deliver energy.
11	While the defibrillator is charged, press the paddles electrodes together and then press and hold the SHOCK button on the Apex paddle (only).	Verify that the defibrillator does not discharge.

	Function	Response
12	While the defibrillator is still charged, press the paddles electrodes together then press and hold the SHOCK button on the Sternum paddle (only).	Verify that the defibrillator does not discharge.
13	While the defibrillator is charged, press the paddles electrodes together then simultaneously press and hold both the Apex and Sternum paddle SHOCK buttons.	Verify that the defibrillator discharges and that a <i>DEFIB SHORT TEST PASSED</i> message displays. If the message <i>DEFIB SHORT TEST FAILED</i> displays, contact the appropriate technical personnel or the ZOLL Technical Service Department.

Recommended Minimum Preventive Maintenance Schedule

Operational Tests should be performed at regular intervals. The Operational Tests augment the automated self-tests that the Propaq MD unit performs to help ensure readiness. For more information, see the Operational Tests in the *Propaq MD Service Manual*.

Annually

In addition to Daily/Shift Check Procedure and Operational Tests, the following is recommended:

- Perform NIBP calibration check.
- Perform CO₂ calibration check.
- The NIBP and CO₂ calibration checks should be performed annually or according to local requirements (to be performed by a qualified Biomedical Equipment Technician (BMET)) as described in the *Propaq MD Service Manual*.

Guidelines for Maintaining Peak Battery Performance

- Each battery should be identified with a number or letter. An identification mark is useful in tracking battery performance.
- Keep extra batteries in the *SurePower* Charger Station where their status can be quickly determined. Illumination of the Ready light is the most positive indication of a fully charged battery.
- Always carry at least one fully charged spare battery. If no other source of back-up power is available, two spare batteries are advisable.
- Rotate spare batteries routinely. The charge level gradually diminishes in a battery after it is removed from the charger even if it is not used. Regular battery rotation helps to avoid incidents where a low battery condition is encountered because the battery has not been recharged or used in more than 30 days.
- Whenever possible, recharge a partially depleted battery. This can be accomplished following any incident that involves patient monitoring. It ensures maximum operating time for each use, without reliance on spares. The need for a spare can then serve as an alert when an aging battery fails to provide normal operating time.
- Keep discharged batteries separated from spare batteries that are charged. When removing a discharged battery from the monitor, never place it in the location intended to carry a charged spare.

Caution DO NOT leave Propaq MD battery packs in a depleted state. Damage to the battery packs can occur if they are left in a depleted state for more than 14 days.

Cleaning instructions

Cleaning the Propaq MD unit

To clean the Propaq MD unit, use a nearly dry cloth containing one of the mild cleaning agents listed below. DO NOT allow cleaning agent or water to run into the crevices or connector openings at any time. Thoroughly wipe off any excess cleaning solution from the Propaq MD unit with a dry cloth.

Always check monitor and connector opening for unusual wear, damage or dampness while cleaning.

Use only these recommended cleaning agents:

- Warm water
- Hydrogen peroxide solution
- Liquid soap
- Wex-cide[®]
- Windex[®]

Never use these cleaning agents:

- Butyl alcohol
- Denatured ethanol
- Freon
- Mild chlorine bleach solution
- Isopropyl alcohol
- Trichloroethane, trichloroethylene
- Acetone
- Vesphene II
- Enviroquat
- Staphene
- Misty
- Glutaraldehyde

Cleaning the NIBP Blood Pressure Cuff

Clean the cuff with common hospital disinfectants, including Clorox[®] (1:10 solution), isopropyl alcohol, Lysol[®] solution, PhisoHex[®], Quatricide[®], Virex[®] and Vesphene[®]. Wash gently with the solution, then rinse. DO NOT allow solution to enter cuff tubes. Allow the cuff and hose to completely dry before patient use.

Cleaning SpO₂ Sensors

Clean the SpO₂ sensors with a cloth that has been slightly dampened with one of the recommended agents listed above. DO NOT submerge the probe or its connector in any liquids or cleaning agents. Thoroughly wipe off any excess cleaning solution with a dry cloth. Allow the sensor to completely dry before patient use.

Cleaning Cables and Accessories

Cables, cuff tubing, paddles and other accessories can be wiped clean with a damp cloth moistened in a mild detergent solution.

Loading Recorder Paper

The unit displays the message *PRINTER OUT OF PAPER* when the printer is activated without recorder paper or if the supply runs out during printing.

Use ZOLL recorder paper (part number 8000-000901).

To load the recorder paper into the printer:

1. Insert your fingers into the indentations on the sides of the printer door, pull the door open, then remove any paper from the spool.

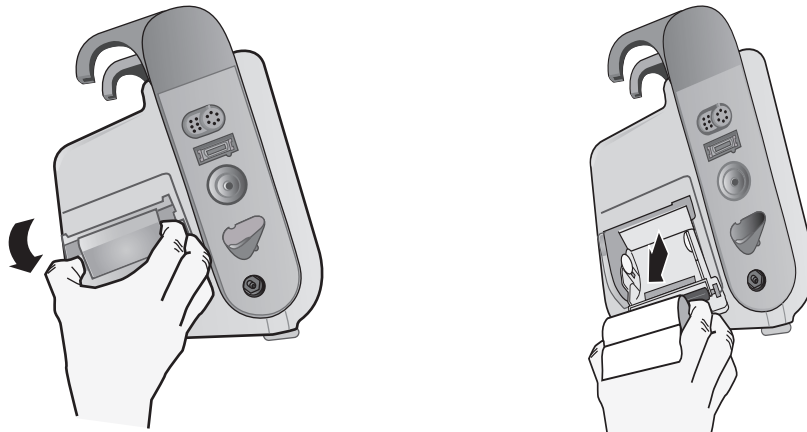


Figure 24-1. Opening the Printer Door and Removing Paper

2. Refer to the illustration inside of the paper compartment for proper paper orientation, and place a new roll of recorder paper on the empty spool.
3. Pull enough paper off the spool so that paper extends out of the unit when the printer cover is closed.

4. Close the printer door. Be sure the cover is flush with the side of the unit.

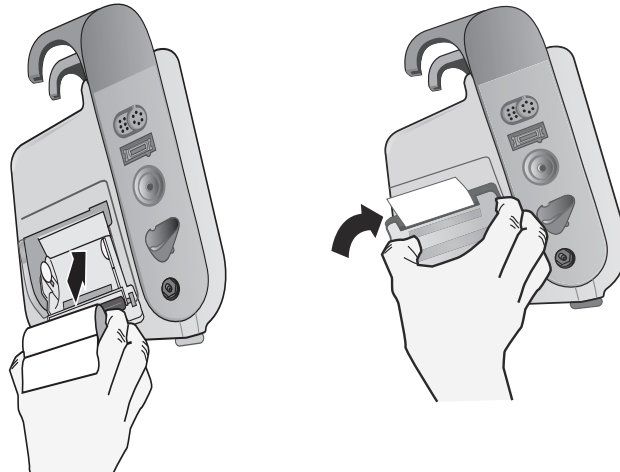


Figure 24-2. Inserting the Paper and Closing Printer Door

5. After the paper is loaded, press the **Print** quick access key () to resume printing.

Cleaning the Print Head

To clean the recorder print head, perform the following steps:

1. Pull the printer door open (see Fig. 24-1), then remove any paper.
2. Locate the print head along the front floor of the printer compartment.
3. Gently wipe the print head with a cotton swab moistened with isopropyl alcohol, and dry any residual alcohol with another dry cotton swab.



Figure 24-3. Cleaning the Print Head

4. Place the paper back into the unit and close the cover (see Fig. 24-2).

Propaq MD OPERATOR'S SHIFT CHECKLIST

Date: _____ Shift: _____ Location: _____
 Mfr/Model No.: _____ Serial No. or Facility ID No.: _____

At the beginning of each shift, inspect the unit. Indicate whether all requirements have been met.
 Note any corrective actions taken. Sign the form.

	Okay as found	Corrective Action/Remarks
1. Defibrillator Unit		
Clean, no spills, and casing undamaged		
2. Cables/Connectors		
a. Inspect for damaged insulation, frayed/broken wires, or bent connector pins b. Connectors engage securely		
3. Sensors (pulse oximetry, NIBP cuff and hose, temperature sensors)		
a. Inspect for signs of damage or excessive wear b. Connectors engage securely		
4. Paddles		
a. Clean, not pitted, or damaged. b. Switches operate freely c. Cables and connectors free of damage and engage securely		
5. Supplies and Accessories		
a. Therapy pads in sealed pouches (2 sets, not expired) b. Defib gel or gel pads c. ECG monitoring electrodes d. Alcohol wipes e. Razors/scissors f. Recorder paper		
6. Batteries		
a. Fully charged battery installed in unit b. Fully charged spare battery available		
7. Ready For Use Indicator shows Ready - No flashing or Do Not Use symbol		
8. Operational Checks		
A. Power Up Sequence		
a. Battery charge and AC indicators illuminate with AC power b. Audio beeps heard and Visual Alarm indicators briefly illuminate c. Self Test passed		
B. Hands Free Defibrillation (Test with only battery power)		
a. <i>CHECK THERAPY ELECTRODES</i> and <i>PADS SHORT DETECTED</i> messages display b. Charge time < 7 seconds c. <i>DEFIB SHORT TEST</i> passed at 30 Joules		
C. Pacer Test (Test with only battery power)		
a. Printer prints Pace markers every 25 mm at 60 ppm b. <i>PACING: SHORT DETECTED</i> message displays-- no error messages at 100 mA c. <i>PACING: CHECK THERAPY ELECTRODES</i> message displays		
D. Paddles		
a. <i>APPLY PADDLES TO PATIENT</i> message displays when paddles are connected to MFC b. Paddle switches functional (Recorder, Energy Select, Charge, Shock) c. <i>DEFIB SHORT TEST</i> passed at 30 Joules		
E. Reconnect Unit to AC Power		
_____ Major problem(s) identified (OUT OF SERVICE)		

Signature _____

Appendix A

Specifications

This chapter provides specification information for the Propaq MD Monitor/Defibrillator.

- “Defibrillator” on page A-2.
- “Monitor/Display” on page A-14
- “Impedance Pneumography” on page A-15
- “Alarms” on page A-16
- “Recorder” on page A-17
- “Battery” on page A-17
- “General” on page A-18
- “Pacer” on page A-19
- “CO2” on page A-19
- “Pulse Oximeter” on page A-20
- “Non-Invasive Blood Pressure” on page A-22
- “Invasive Pressures” on page A-23
- “Temperature” on page A-24
- “Electromagnetic Compatibility Guidance and Manufacturer’s Declaration” on page A-29
- “ECG Analysis Algorithm Accuracy” on page A-35
- “Wireless Output Guidance and Manufacturer’s Declaration” on page A-39

Defibrillator

Charge Time:

- Less than 7 seconds with a new, fully charged battery (first 15 charges to 200 joules).
- For the sixteenth discharge at maximum energy, the charge time is less than 10 seconds. Depleted batteries result in a longer defibrillator charge time.
- Less than 15 seconds when operating without a battery, using AC power alone at 90% of the rated mains voltage.
- Less than 25 seconds from the initial power on, with a new, fully charged battery pack (depleted by up to fifteen 200 joule discharges) or when operating without a battery, using AC power alone at 90% of the rated mains voltage.

Rhythm Analysis and Charge Time in AED Mode

- Less than 30 seconds with a new, fully charged battery (first 15 charges to 200 joules).
- For the sixteenth discharge at maximum energy, the analysis and charge time is less than 30 seconds. Depleted batteries result in a longer defibrillator charge time.
- Less than 30 seconds when operating without a battery, using AC power alone at 90% of the rated mains voltage.
- Less than 40 seconds from the initial power on, with a new, fully charged battery pack (depleted by up to fifteen 200 joule discharges) or when operating without a battery, using AC power alone at 90% of the rated mains voltage.

Patient Impedance Range: 10- 300 ohms

Synchronized Mode: Synchronizes defibrillator discharge to the patient's R wave. SYNC is indicated on the display with R wave markers above the ECG waveform on the screen and stripchart. When ECG is monitored by the device, meets the DF-80:2003 requirement of 60ms maximum time delay between the peak of the R wave and the delivery of energy.

Table A-1 shows the characteristics of the Propaq MD Rectilinear Biphasic™ waveform when discharged into 25 ohm, 50 ohm, 100 ohm, 125 ohm, 150 ohm and 175 ohm loads at the maximum energy setting of 200 joules.

Table A-1. Propaq MD Rectilinear Biphasic Waveform Characteristics

	200 J discharged into					
	25Ω	50Ω	100Ω	125Ω	150Ω	175Ω
First phase						
Maximum initial current	31.4 A	30.4 A	19.7 A	19.4 A	16.7 A	15.6 A
Average current	27.1 A	24.9 A	17.5 A	16.2 A	14.4 A	13.2 A
Duration	6 ms	6 ms	6 ms	6 ms	6 ms	6 ms
Interphase duration (between first and second phases)						
	200 μs	200 μs	200 μs	200 μs	200 μs	200 μs
Second phase						
Initial current	29.2 A	18.8 A	15.1 A	13.2 A	12.1 A	11 A
Average current	14.7 A	13 A	12.5 A	11.3 A	10.7 A	9.9 A
Duration	4 ms	4 ms	4 ms	4 ms	4 ms	4 ms

Table A-2. Delivered Energy at Every Defibrillator Setting into a Range of Loads

Selected Energy	Load							Accuracy*
	25Ω	50Ω	75Ω	100Ω	125Ω	150Ω	175Ω	
1 J	1 J	1 J	1 J	1 J	1 J	1 J	1 J	±15%
2 J	1 J	2 J	2 J	2 J	2 J	2 J	2 J	±15%
3 J	2 J	3 J	3 J	3 J	3 J	3 J	3 J	±15%
4 J	3 J	4 J	4 J	5 J	5 J	5 J	4 J	±15%
5 J	3 J	5 J	6 J	6 J	6 J	6 J	6 J	±15%
6 J	4 J	6 J	7 J	7 J	7 J	7 J	7 J	±15%
7 J	5 J	7 J	8 J	8 J	8 J	8 J	8 J	±15%
8 J	5 J	8 J	9 J	9 J	10 J	9 J	9 J	±15%
9 J	6 J	9 J	10 J	11 J	11 J	11 J	10 J	±15%
10 J	7 J	10 J	12 J	12 J	12 J	12 J	12 J	±15%
15 J	10 J	16 J	17 J	18 J	18 J	18 J	17 J	±15%
20 J	14 J	21 J	23 J	24 J	24 J	24 J	23 J	±15%
30 J	21 J	32 J	35 J	36 J	37 J	36 J	35 J	±15%
50 J	35 J	54 J	59 J	61 J	62 J	61 J	59 J	±15%
70 J	49 J	76 J	83 J	85 J	87 J	86 J	83 J	±15%
85 J	60 J	92 J	101 J	104 J	106 J	104 J	101 J	±15%
100 J	71 J	109 J	119 J	122 J	125 J	123 J	119 J	±15%
120 J	85 J	131 J	143 J	147 J	150 J	147 J	143 J	±15%
150 J	107 J	164 J	180 J	183 J	188 J	184 J	179 J	±15%
200 J	142 J	230 J	249 J	253 J	269 J	261 J	260 J	±15%

* For all energy levels, accuracy is equal to either ±15% or 3 joules, whichever is greater.

The Propaq MD Rectilinear Biphasic waveform employs the same first and second phase timing, similar first and second phase currents/voltages, and essentially the same mechanisms for controlling defibrillation waveshape as the ZOLL R Series[®] defibrillator. The R Series and Propaq MD defibrillation waveforms are considered substantially equivalent.

Figures A-1 through A-20 show the Rectilinear Biphasic waveforms that are produced when the Propaq MD defibrillator is discharged into loads of 25, 50, 75, 100, 125, 150, and 175 ohms at each energy setting.

The vertical axis shows the current in amperes (A); the horizontal axis shows the duration of time in milliseconds (ms).

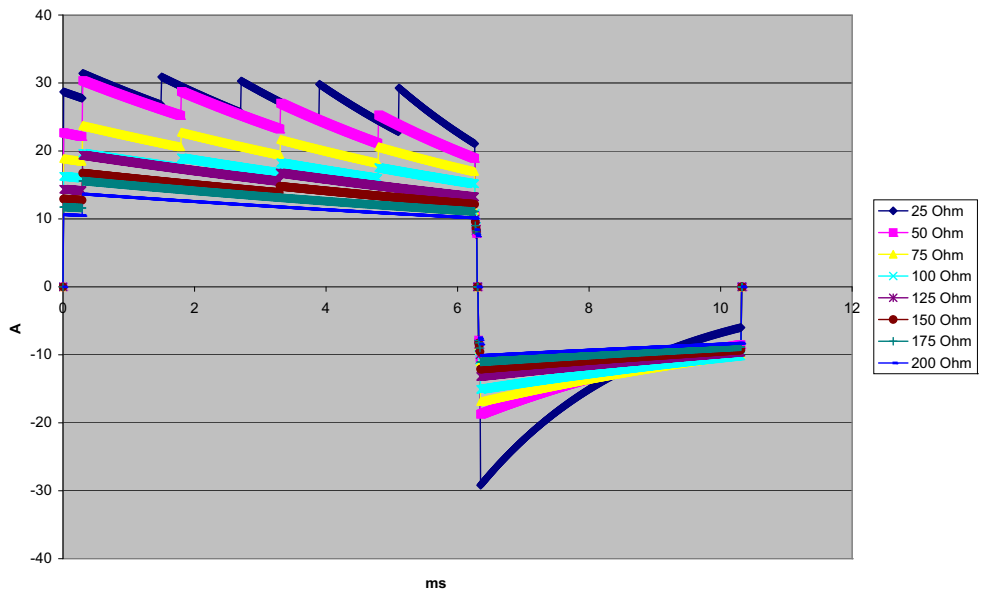


Figure A-1. Rectilinear Biphasic Waveform at 200 Joules

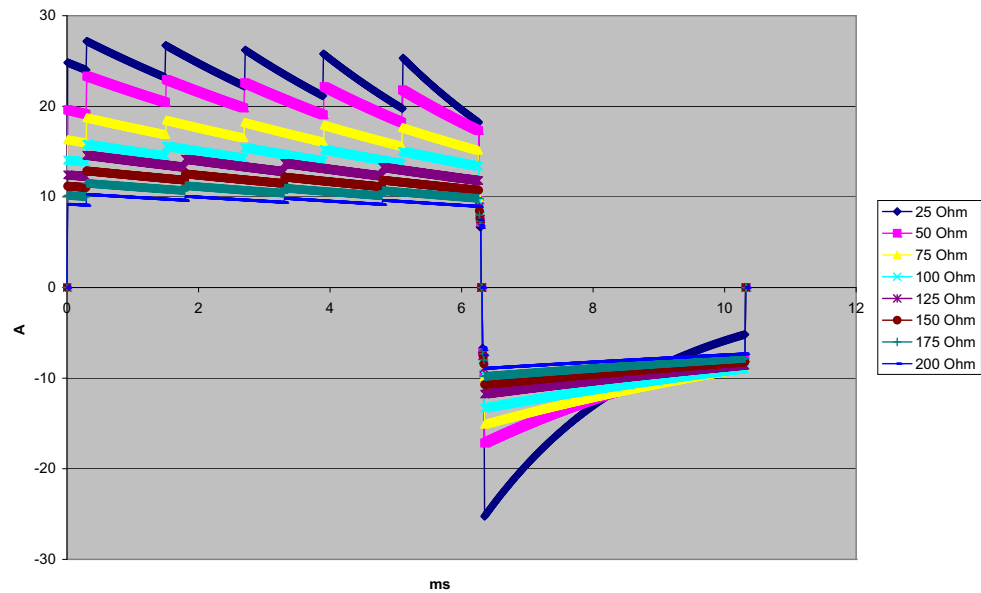


Figure A-2. Rectilinear Biphasic Waveform at 150 Joules

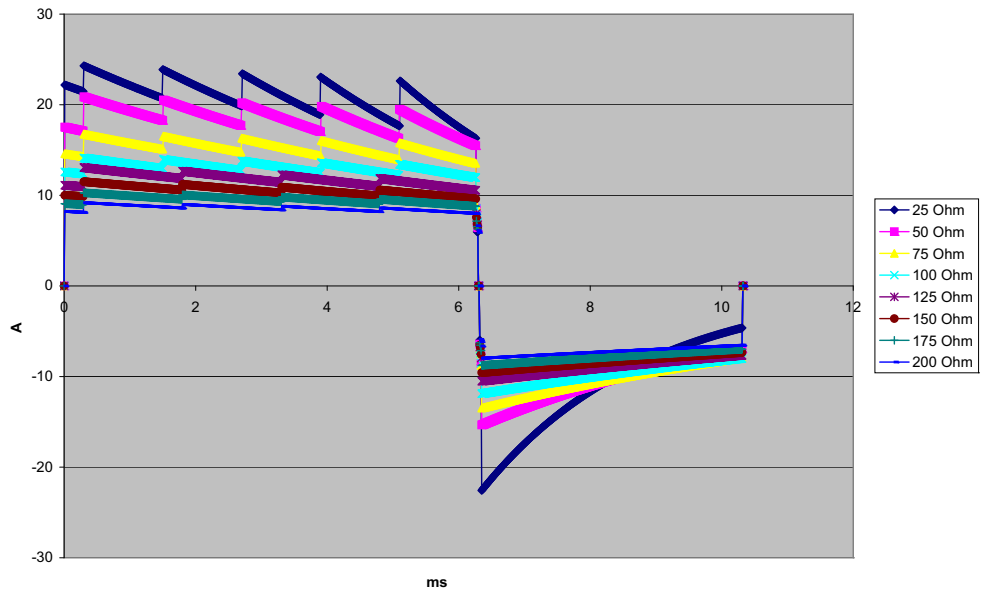


Figure A-3. Rectilinear Biphasic Waveform at 120 Joules

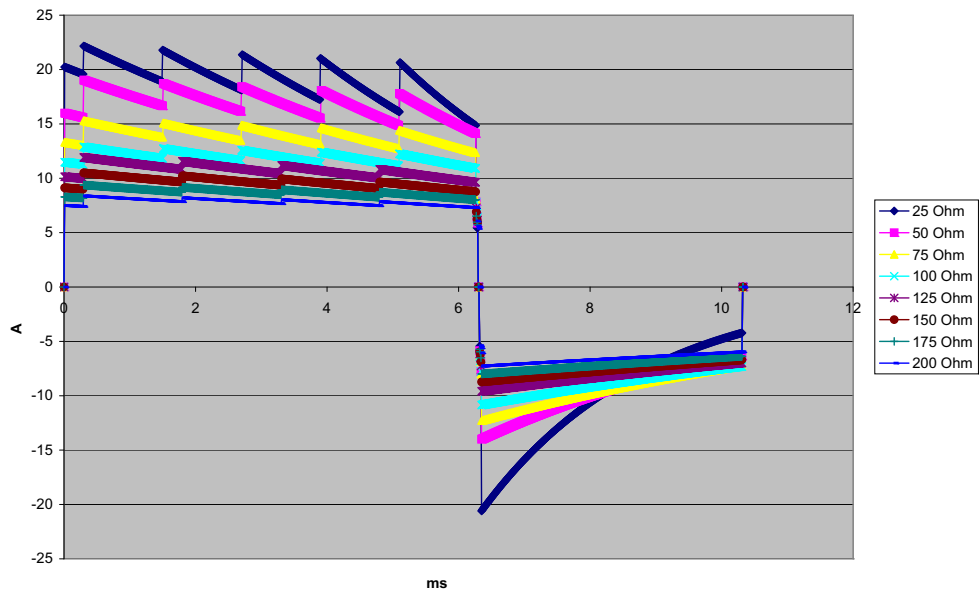


Figure A-4. Rectilinear Biphasic Waveform at 100 Joules

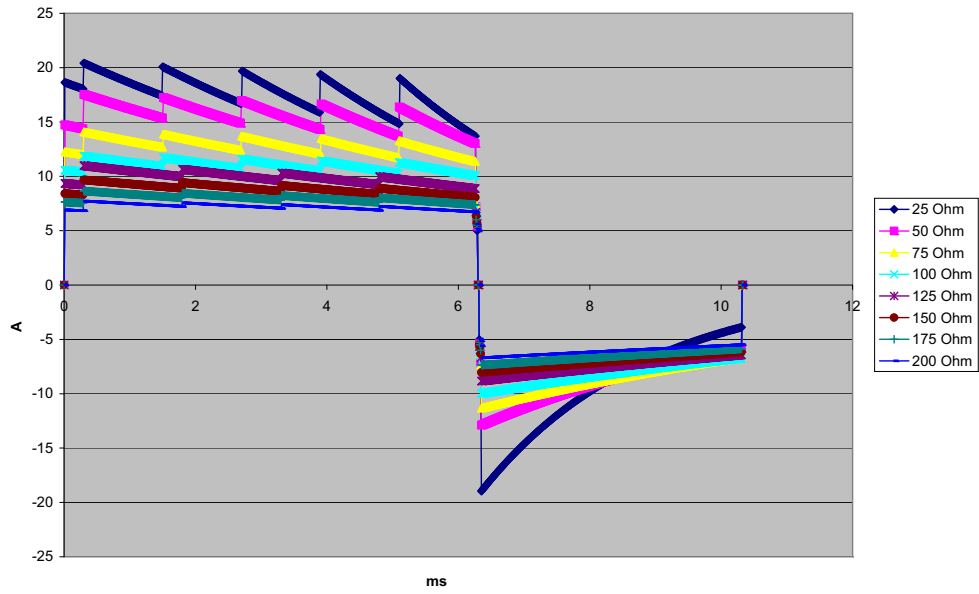


Figure A-5. Rectilinear Biphasic Waveform at 85 Joules

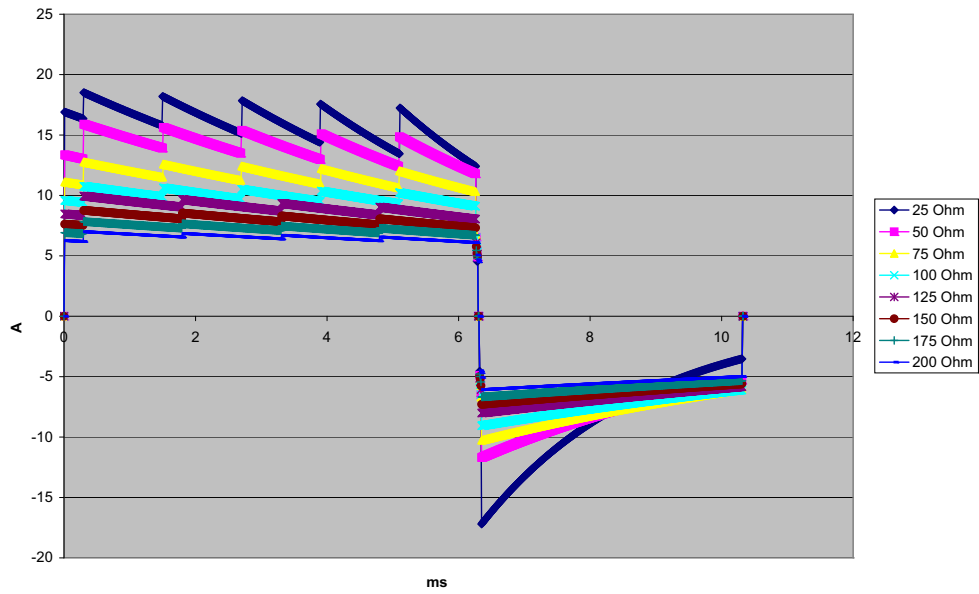


Figure A-6. Rectilinear Biphasic Waveform at 70 Joules

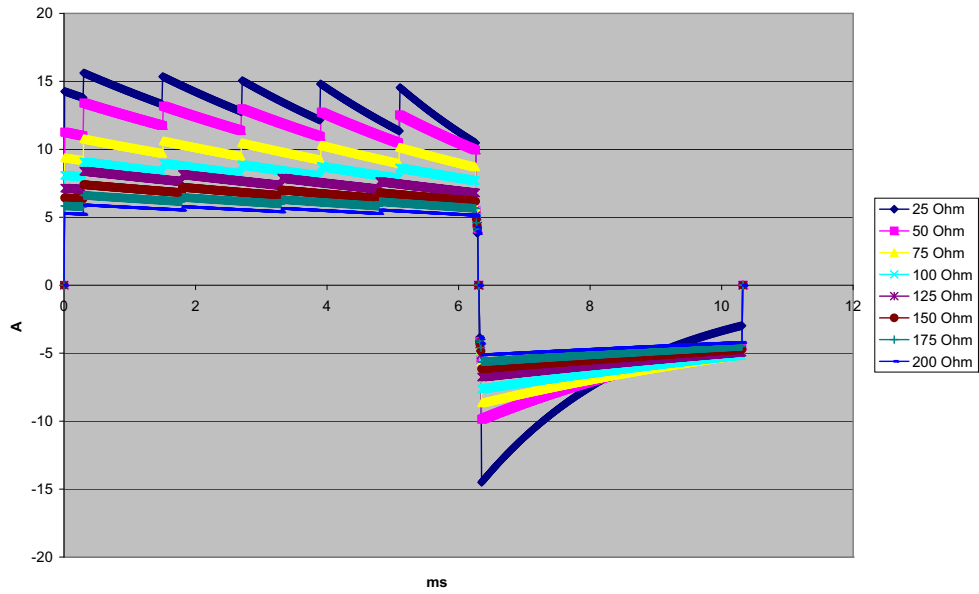


Figure A-7. Rectilinear Biphasic Waveform at 50 Joules

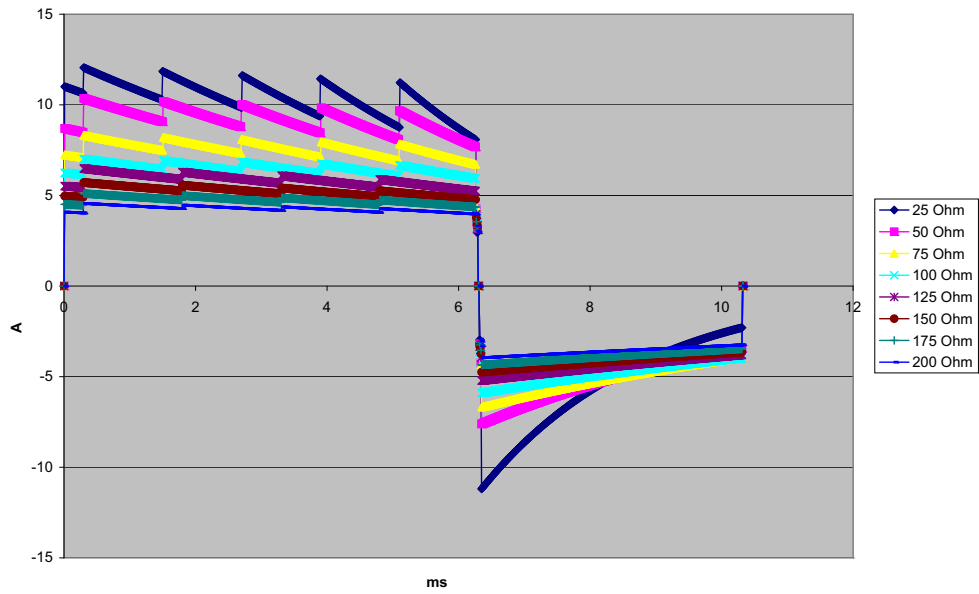


Figure A-8. Rectilinear Biphasic Waveform at 30 Joules

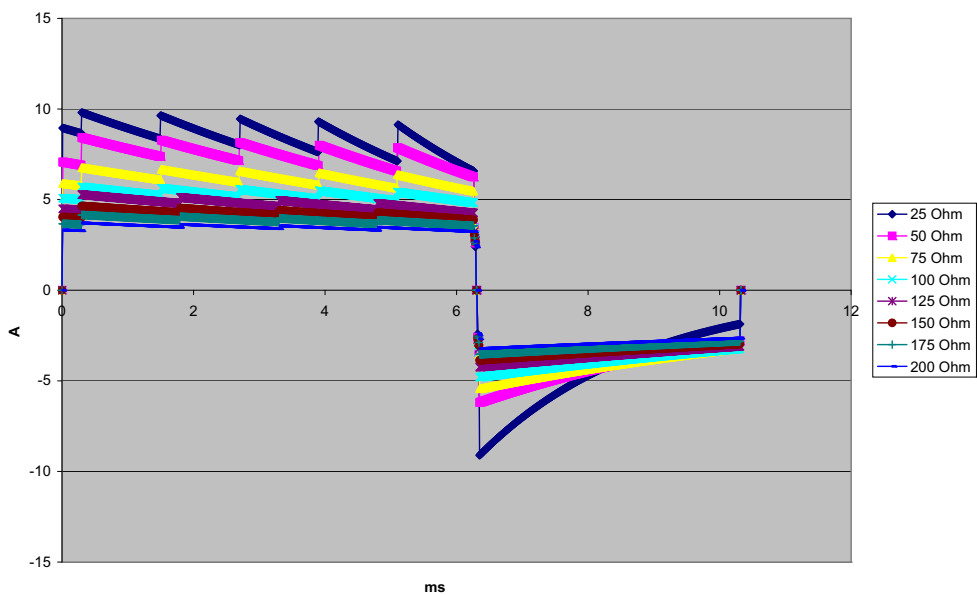


Figure A-9. Rectilinear Biphasic Waveform at 20 Joules

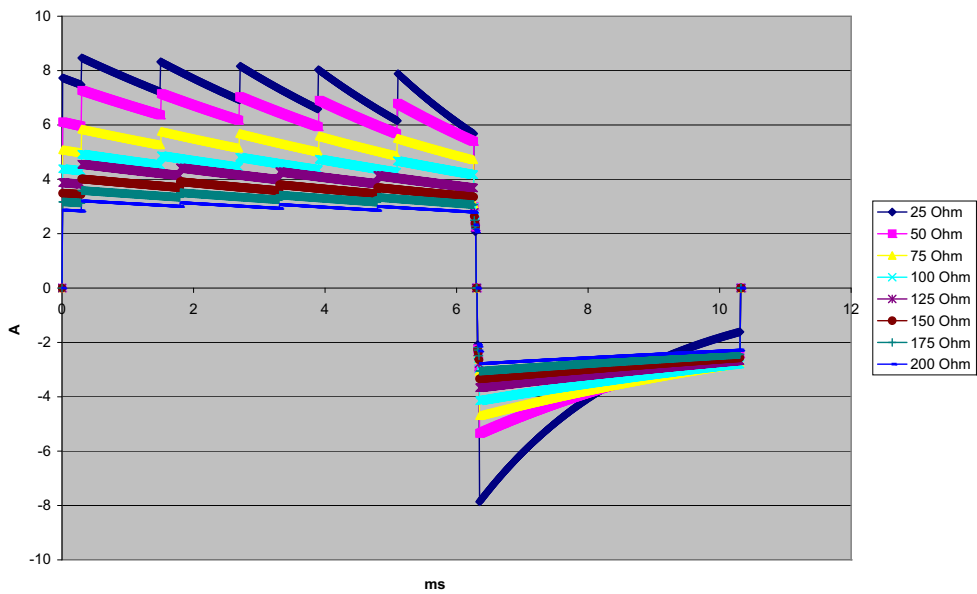


Figure A-10. Rectilinear Biphasic Waveform at 15 Joules

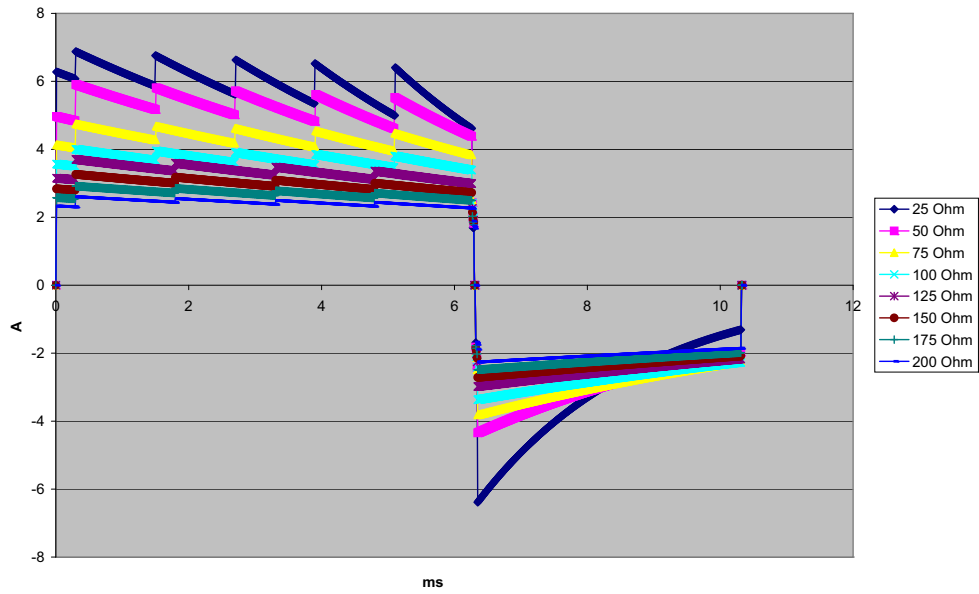


Figure A-11. Rectilinear Biphasic Waveform at 10 Joules

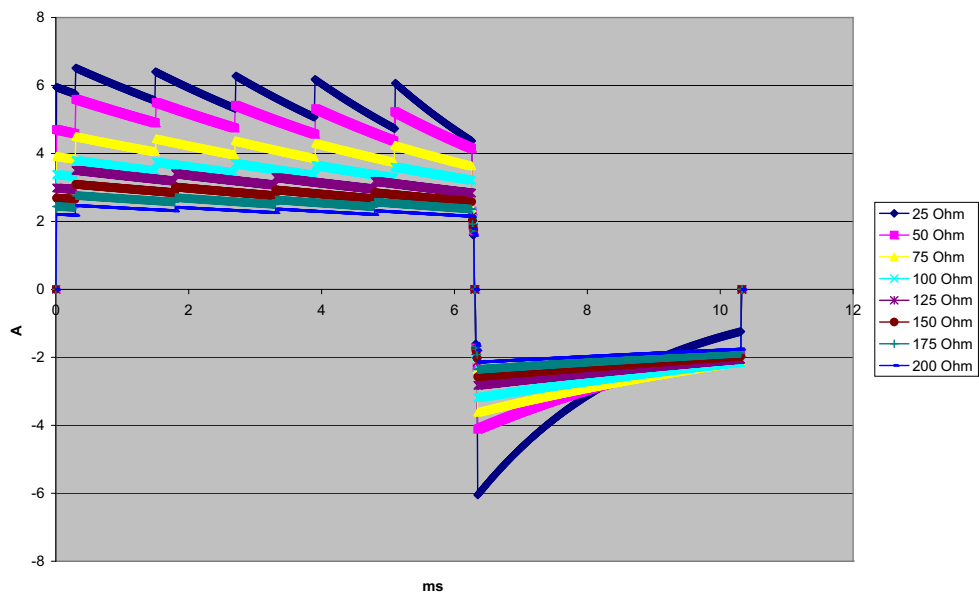


Figure A-12. Rectilinear Biphasic Waveform at 9 Joules

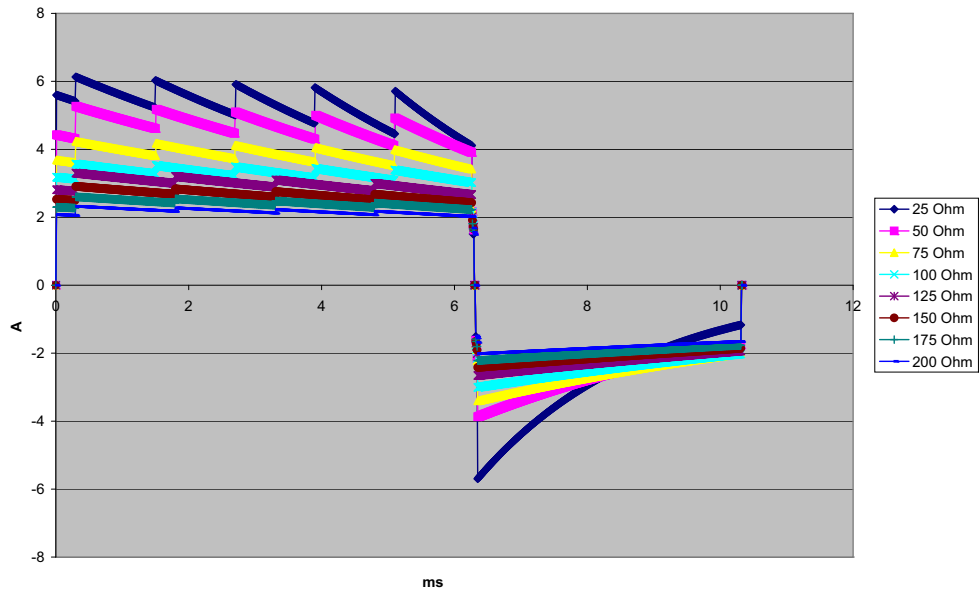


Figure A-13. Rectilinear Biphasic Waveform at 8 Joules

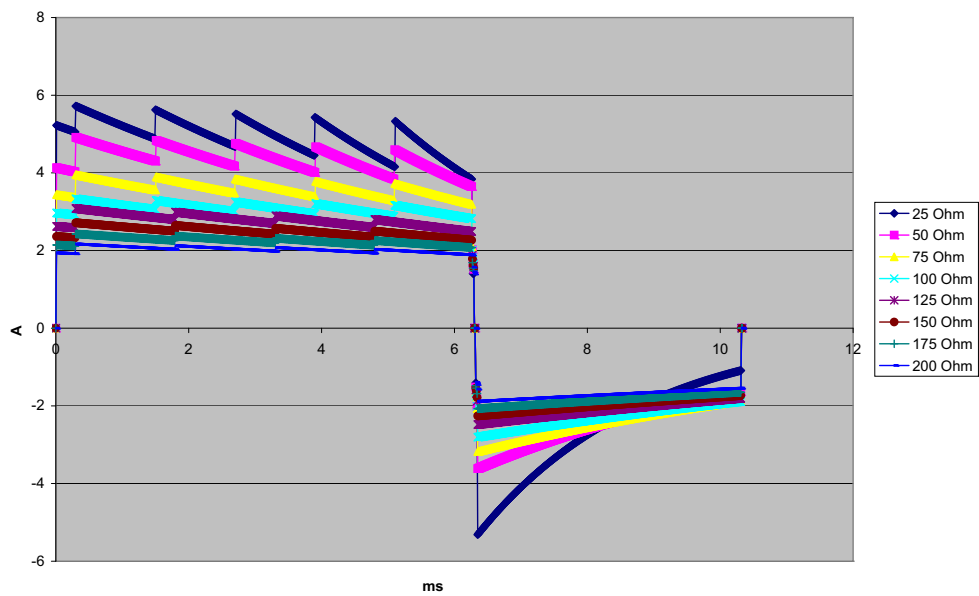


Figure A-14. Rectilinear Biphasic Waveform at 7 Joules

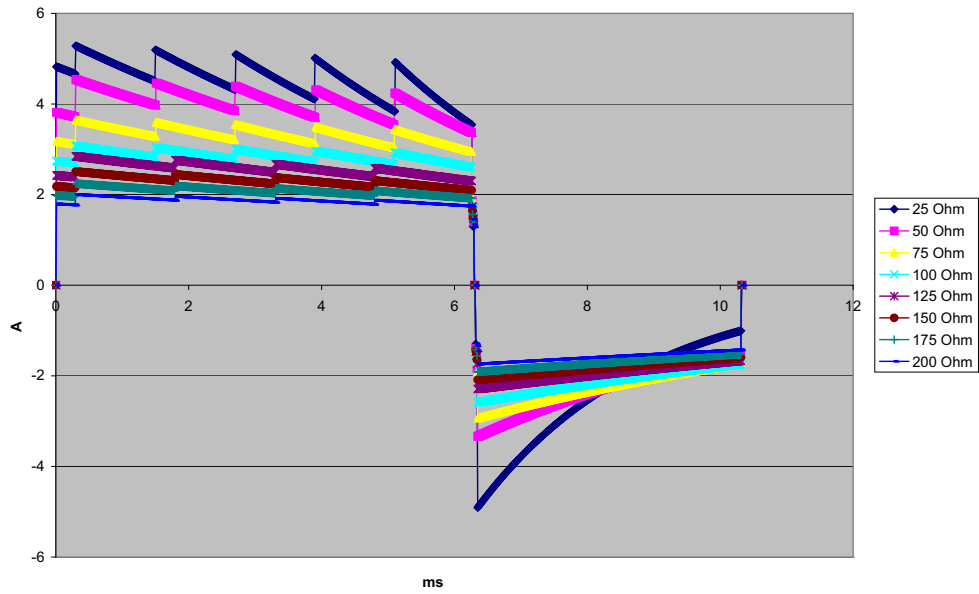


Figure A-15. Rectilinear Biphasic Waveform at 6 Joules

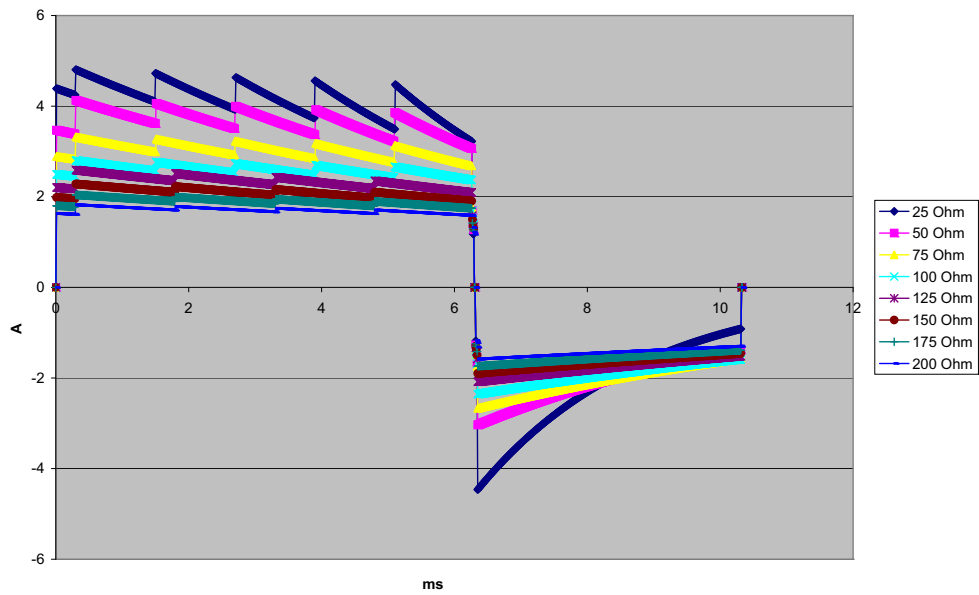


Figure A-16. Rectilinear Biphasic Waveform at 5 Joules

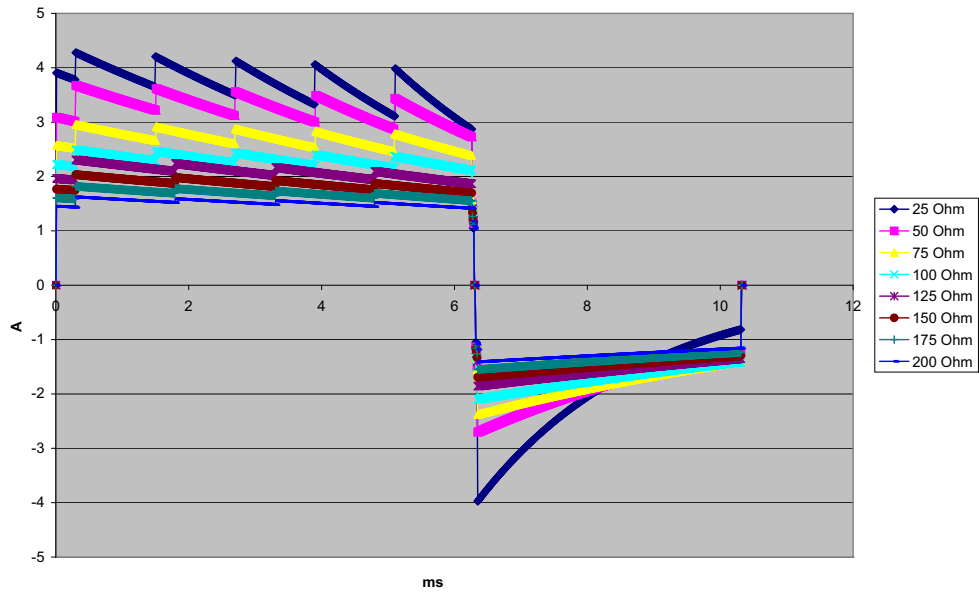


Figure A-17. Rectilinear Biphasic Waveform at 4 Joules

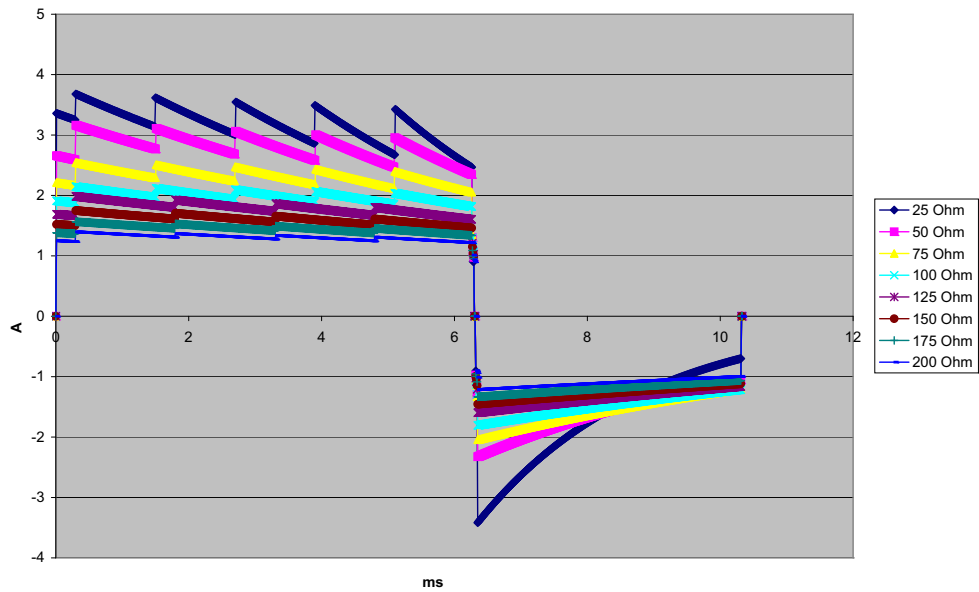


Figure A-18. Rectilinear Biphasic Waveform at 3 Joules

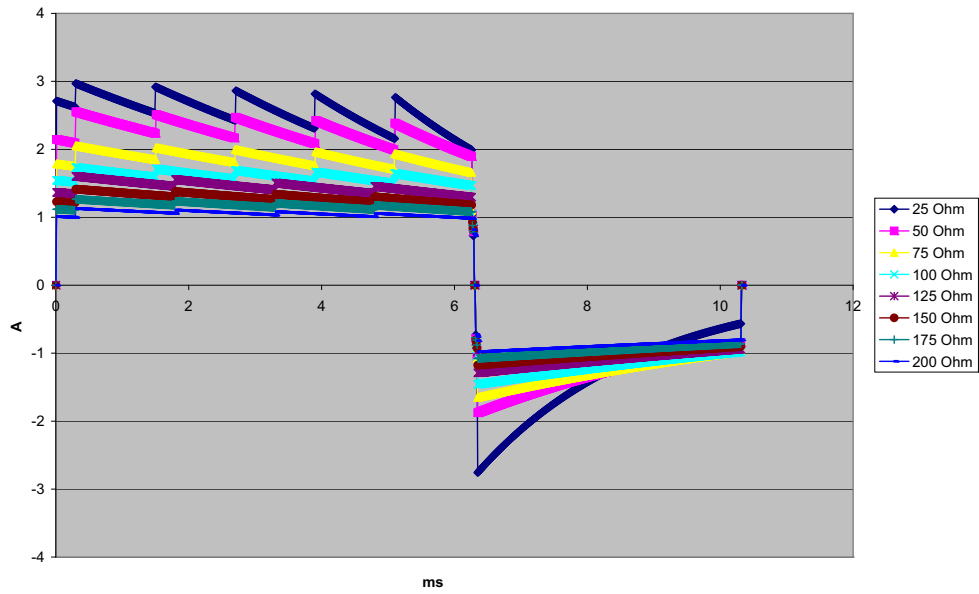


Figure A-19. Rectilinear Biphasic Waveform at 2 Joules

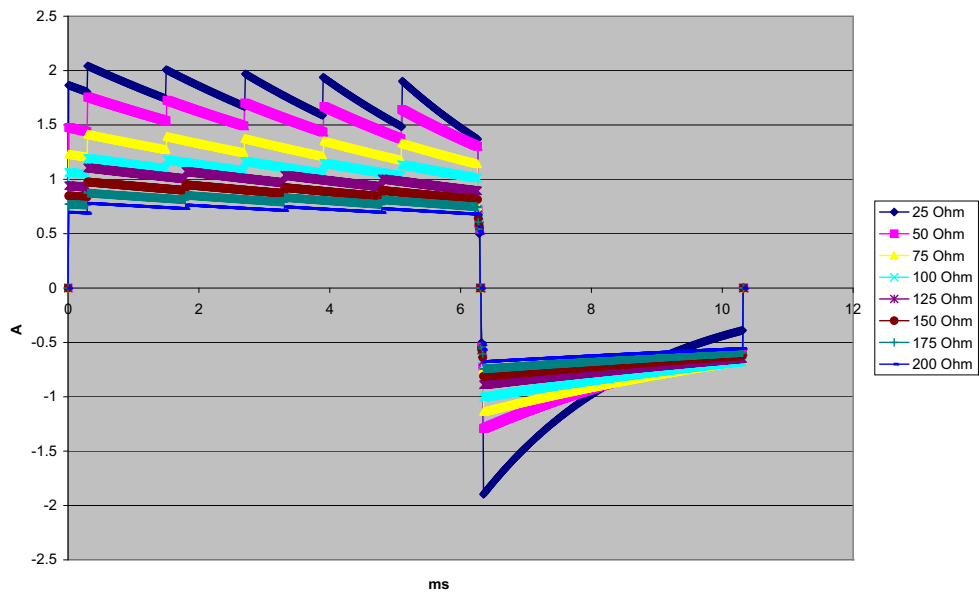


Figure A-20. Rectilinear Biphasic Waveform at 1 Joule

Monitor/Display

Input: 3-lead, 5-lead, or 12-lead patient cable, paddles, Multifunction or OneStep electrodes.

Type: Color LCD, 640 x 480 pixels, 800 MCD

Sweep Speed: 25 mm / sec or 50 mm / sec (User Selectable)

Lead Selections: Paddles (Pads), I, II, III, AVR, AVL, AVF, V1-6.

Frequency Response:

Pads/Paddles:

0.67 to 20Hz Limited response

3/5/12 Lead Continuous Monitoring (user selectable):

0.67 to 20Hz Limited response

0.67 to 40Hz Monitor response

Acquired 12-lead snapshots (supervisor selectable):

0.525 to 40Hz Filtered Diagnostic response

0.525 to 150Hz Diagnostic response

Per methods a, b, c of EC11 3.2.7.2

(Automatically sets chart recorder response)

Common Mode Rejection:

Complies with AAMI EC13-2002 section 4.2.9.10.

Tall T-Wave Rejection:

Meets AAMI EC13-2002, section 4.1.2.1c for 0.9 mV

T-wave (0.8 mV with diagnostic response) and 1mV QRS.

Diagnostic Signals Applied to Patient Connections:

Leads off / active noise suppression sensing circuit is < 0.1 microamps DC. The impedance /respiration detector signal frequency is 72 ± 7 kHz at 77 microamps RMS pseudo-sinewave into 100 ohms.

Heart Rate Range: 30 to 300 BPM.

Heart Rate Accuracy: +/- 3% or +/- 3BPM, whichever is greater.

Displayed Heart Rate: Average of last 5 beat-to-beat intervals.

Heart Rate Alarms: User-selectable.

Size: 0.125, 0.25, 0.5, 1, 2, 4 cm/mv and auto-ranging.

Heart Rate Meter Response Time:

Responds to a 40 BPM step increase in heart rate within 4.5 seconds per AAMI EC-13-2002, section 4.1.2.1.f. Responds to a 40 BPM step decrease within 3.9 seconds per AAMI EC-13-2002, section 4.1.2.1.f. Response times include a 1.0-second display update interval.

Heart Rate Response to Irregular Rhythm: (AAMI EC13-2002, section 4.1.2.1.e.)

Ventricular Bigeminy: 80 BPM (expected)

Slow Alternating Ventricular Bigeminy: 60 BPM (expected)

Rapid Alternating Ventricular Bigeminy: 120 BPM (expected)

Bidirectional Systole: 45 BPM (expected)

Tachycardia Response Time:

Response time to tachycardia alarm is on average 3.4 seconds per AAMI EC-13-2002, section 4.1.2.1.g, and IEC 60601-2-27:2011, subclause 201.7.9.2.9.101 b) 6). Response times include a 1.0 second display update interval.

Pacemaker Pulse Rejection:

(In accordance with AAMI EC13:2002, section 4.1.4 and IEC 60601-2-27:2011, subclause 201.12.1.101.13)

- Pulses without overshoot: Rejects all pulses with amplitude of +2 mV to +700 mV and duration of 0.1 ms to 2 ms, with no tail.
- Pulses with overshoot: Rejects all pulses with amplitude of +2 mV to +700 mV and duration of 0.1 ms to 2 ms, with overshoot up to 100 ms.
- A-V sequential pulses: A-V sequential pacemaker pulses may not be rejected.
- Fast ECG signals: Approximately 50% of ECG input pulses with a slew rate of 3 V/s RTI may trigger the pacemaker pulse detector.

Electrosurgery Protection: The Propaq MD is suitable for use in the presence of electrosurgery as specified in IEC 60601-2-27. Burn hazard protection via a 1K current limiting resistor contained in each ECG leadwire.

Impedance Pneumography

Displayed Data: Numeric breath rate, Impedance waveform

Breath rate range: Adult, Ped: 2 to 150 breaths / minute

Neonates: 3 to 150 breaths / minute

Breath rate accuracy: 2% or +/- 2 breaths / minute, whichever is greater

Displayed Breath Rate: Average of last 10 breath-to-breath rates.

Leads: Lead I (RA – LA), Lead II (RA – LL)

Sweep Speed: 3.13, 6.25, 12.5 mm/sec

Alarm settings: High, low and no breath rate alarm

Alarms

Heart Rate Alarms:

Audible: 5 pulse, 900 Hz tone, with a PW of 125 msec, a PRI of 250 msec, and a repetition interval of 15 seconds.

Visual: Heart Rate Alarm causes the heart rate to be displayed in red, with a white background. The red device status LED will flash a rate of 1.7 Hz.

Lead Fault Alarm:

Audible: 3 pulse, 500 Hz, triplet tone with a PW of 200 msec, a PRI of 200 msec. The lead fault tone repeats at a repetition interval of 30 seconds.

Visual: Lead Fault condition causes a LEAD FAULT message to be displayed on the trace along with a dashed line the width of the trace.

Physiological Alarms (NIBP, SpO₂, Resp, CO₂, IP & Temp):

Audible: Same as Heart Rate Alarm

Visual: Physiological alarms cause the alarming parameter to be displayed in Red with a white background. The red device status LED will flash at a rate of 1.7 Hz.

Audio Pause (Silence) Duration: 90 seconds.

Invalid Operation Alert Tone:

A short, low-pitched tone is audible when a selected control button is unavailable for use or an invalid entry is detected. Tone frequency is 160 Hz. Duration is 250 msec.

Maximum Alarm Delay (Includes Alarm Condition Delay and Signal Generation Delay):

Heart rate/pulse rate:

- if source is ECG, 9 seconds
- if source is SpO₂, 10 seconds
- if source is IBP, 6 seconds
- if source is NIBP, no hold off

SpO₂, SpCO, and SpMet Saturation: 10 seconds

EtCO₂: 7 seconds

FiCO₂: 5 seconds

IBP (Systolic, Diastolic, Mean): 3 seconds

Temperature: 2 seconds

Recorder

Type: High-resolution thermal array.

Annotation: Time, date, ECG lead, ECG gain, heart rate, defibrillation and pacing parameters and treatment summary events.

Paper Width: 80 mm.

Paper Speed: 25 mm/sec, 50 mm/sec

Delay: 6 seconds.

Frequency Response: Automatically set to monitor's frequency response.

Treatment Summary:

10 switches to record key ACLS events (IV, INTUB, EPI, LIDO, ATROP, etc.).
Automatically logs into memory the type of event, time and ECG sample.

Full Disclosure Case Log: A combination of 32 monitor snapshots; 500 non-ECG events; and 24 hours of continuous ECG (4 waveforms), Capnography, IBP (3 channels), and Pads Impedance. The actual information stored can be more or less depending on the use profile and the log configuration settings.

Record Modes: Manual and automatic (User-configurable).

Battery

Type: Rechargeable Lithium-Ion, 11.1Vdc, 6.6 Ah, 73Wh

Capacity:

With a new, fully charged battery operating at room temperature:

- At least 6 hours of continuous monitoring of ECG, SpO₂, CO₂, three Invasive Pressure channels, and 2 channels of Temperature, with NIBP measurements every 15 minutes and 10 200 J shocks (display set to 30%).
- At least 100 discharges at maximum shock energy (200 joules).
- At least 3.5 hours pacing, with ECG, SPO₂, CO₂, three Invasive Pressures, temperature, NIBP every 15 minutes and pacing at 180 ppm, and 140 mA.
- At least 300 discharges at maximum shock energy (200 joules) with no parameters and 70% brightness.
- At least 10 discharges at maximum shock setting (200 joules) after a Low Battery indication.

Note: Proper battery care is required to maintain maximum available capacity.

Battery Indicators:

5 Battery capacity LED indicators, Fault indicator, Recalibration indicator

Recharge Rate: 100% in 4 hours, when initiated at Low Battery indication.

General

Weight:

10.6 lbs. without battery and paper

11.7 lbs. with battery and paper

Dimensions:

Without Handle: 8.9" x 8.75" x 7.9"

With Handle: 8.9" x 10.4" x 7.9"

Operating:

Temperature: 0 to 50° C

Humidity: 15 to 95% RH (non-condensing)

Vibration:

- EN ISO 9919 (per IEC 60068-2-64)
- RTCA/DO-160G (multiple helicopter frequencies)
- EN 1789 for ambulance

Shock: IEC 60068-2-27, 100g, 6ms half sine

Bump: EN 1789 (IEC 60068-2-29)

Drop: EN 1789, 30" functional drop

IEC 60601-1, Tested at 2 meters

Altitude: -170 M to 4572 M (-557 feet to 15,000 feet)

Transport and Storage:

Temperature: -30 to 70°C

Note: The Propaq MD device may not perform to specifications when stored at the upper or lower extreme limits of storage temperature and immediately put into use.

Humidity: 15 to 95% RH (non-condensing)

Atmospheric pressure: 572 mbar to 1034 mbar

Shock/vibration: MIL STD 810G, Method 514.6, 4.4.2, Procedure II

Safety Classification: Class 1 and internal power per IEC/EN 60601-1

Enclosure Protection:

Solid Foreign Object: IEC 60529, IP5X

Water: IEC 60529, IPX5

Auxiliary Operating Power:

Auxiliary Power Adapter, 8300-0004

Input: 100-240V \curvearrowright 50-60 Hz, 2A

100-115V \curvearrowright 400 Hz, 2A

Output: 14.5V --- 4.15A

80W (peak)

IP Rating: IP23

Pacer

Type: External transcutaneous pacing

Pacer Rate: 30 to 180 BPM \pm 1.5%.

Output Current: 0 to 140 mA \pm 5% or 5 mA (whichever is greater)

Modes: Demand and Fixed

Status Indicators:

ECG lead fault, pace marker on monitor and chart, start/stop indicator on display.

Pulse Type: Rectilinear, constant current

Pulse Width: 40 ms \pm 2 ms

CO₂

Range: 0 to 150 mmHg

Accuracy CO₂:

CO ₂ Partial Pressure*	Accuracy **
0-38 mmHg	\pm 2 mmHg
39-99 mmHg	\pm (5% of reading + 0.08% for every 1 mmHg above 38 mmHg)
100-150 mmHg	\pm (5% of reading + 0.08% for every 1 mmHg above 38 mmHg)

* At sea level.

** Accuracy applies for breath rates of up to 80 bpm. For breath rates above 80 bpm, accuracy is 4 mmHg or \pm 12% of reading whichever is greater, for EtCO₂ values exceeding 18 mmHg. This is tested according to and is compliant with ISO 21647. To achieve the specified accuracies for breath rates above 60 breaths/minute, the Microstream FilterLine H Set for Infant/Neonatal must be used. Above 40 C, \pm 1mmHg or \pm 2.5% (whichever is greater) has to be added to the tolerance of the accuracy specs.

CO₂ Sampling Rate: 50 msec

Drift of Measurement Accuracy: Over any 24-hour period, the accuracy claims listed above are maintained.

The accuracy specification is maintained to within 4% for the following gas mixtures (all values are in Vol.%).

CO ₂	N ₂	O ₂	N ₂ O	H ₂ O	Anesthetic Agents
1.0 to 13	0 to 97.5	0 to 100	0 to 80	Dry to saturated	According to EN 21647

Respiration Range: 0 to 149 breaths per minute

Respiration Rate Accuracy:

0 to 70 bpm: \pm 1 bpm

71 to 120 bpm: \pm 2 bpm

121 to 149 bpm: \pm 3 bpm

Flow rate: 50 ml/min -7.5 + 15 ml/min, flow measured by volume.

Total System Response Time: 2.9 seconds typical, 3.9 seconds maximum.

Pulse Oximeter

Range:	Oxygen Saturation (% SpO ₂)	0% - 100%
	Carboxyhemoglobin Saturation (% SpCO)	0% - 99%
	Methemoglobin Saturation (% SpMet)	0% - 99%
	Total Hemoglobin (g/dL SpHb)	0 – 25 g/dL
	Total Oxygen Content (% SpOC)	0 – 35 ml/dL
	Perfusion Index (% PI)	0.02% - 20%
	Pleth Variable Index (% PVI)	0% - 100%
	Pulse Rate (bpm)	25 - 240 beats per minute

Accuracy: Oxygen Saturation (% SpO₂) - During No Motion Conditions

Adults, Pediatrics ¹	70% - 100%, ±2 digits	0% - 69%, unspecified
Neonates ²	70% - 100%, ±3 digits	0% - 69%, unspecified

Oxygen Saturation (% SpO₂) - During Motion Conditions³

Adults, Pediatrics	70% - 100%, ±3 digits	0% - 69%, unspecified
Neonates	70% - 100%, ±3 digits	0% - 69%, unspecified

Oxygen Saturation (% SpO₂) - During Low Perfusion Conditions⁴

Adults, Pediatrics	70% - 100%, ±2 digits
Neonates	70% - 100%, ±3 digits

Carboxyhemoglobin Saturation (% SpCO)⁵ 1% - 40% ±3 digits

Methemoglobin Saturation (% SpMet)⁵ 1% - 15% ±1 digit

Total Hemoglobin (ml/dL SpHb)⁶

Adults, Pediatrics 8 – 17 ±1 g/dL (arterial or venous)

Pulse Rate (bpm) - During No Motion Conditions¹

Adults, Pediatrics, Neonates 25 - 240 ±3 digits

Pulse Rate (bpm) - During Motion Conditions³

Adults, Pediatrics, Neonates 25 - 240 ±5 digits

Resolution:

- SpO₂: 1%
- SpCO: 1%
- SpMet: 0.1% for range up to 9.9%, 1% for range 10 - 99%
- SpHb: 0.1 g/dL
- SpOC: 0.1 ml/dL
- PVI: 1%
- PI: 0.1%
- Pulse rate: 1 bpm (beats per minute)

Alarm Limits: On/Off displayed on monitor. User selectable.

- SpO₂: High 72 - 100% saturation, Low 70 - 98% saturation
- SpCO: High 2 - 100% saturation, Low 0 - 99% saturation
- SpMet: High 1 - 100% saturation, Low 0 - 99% saturation
- SpHb: High 2 - 25 g/dL, Low 0 - 24.9 g/dL
- SpOC: High 0.1 – 35 ml/dL, Low 0 – 34.9 ml/dL
- PVI: High 2 – 100%, Low 0 – 98%
- PI: 0.2 – 20%, Low 0 – 19.8%
- Pulse Rate: High 60 - 235 beats per minute, Low 20 - 100 beats per minute

SpO₂ Wavelength for LNCS Sensors:

Nominal Red LED Wavelength: 660 nanometers
Nominal Infrared LED Wavelength: 905 nanometers

Energies (Radiant Power) of light for LNCS Sensors at 50 mA pulsed:

≤ 15 mW

SpO₂ Wavelength for Rainbow Sensors:

The Rainbow sensors use 8 different LEDs with wavelengths of 610 - 905 nanometers

Energies (Radiant Power) of light for Rainbow Sensors at 100 mA pulsed:

≤ 25 mW

Bio-Compatibility:

Patient contacting material meets requirements of ISO 10993-1, Biological Evaluation of Medical Device - Part I, for external devices, intact surfaces and short-term exposure

Environmental:

Operating Temperature: 0° to 50° C (32° to 122° F)
Storage Temperature: -40° to 70° C (-40° to 158° F)

Electromagnetic Immunity (SpO₂ Option Only):

AAMI DF-80; EN61000-4-3:2002 to 10 V/m

Note: The Propaq MD Pulse Oximetry Option is calibrated for functional saturation.

1 The Masimo SET Technology with LNCS sensors has been validated for no motion accuracy in human blood studies on healthy adult volunteers in induced hypoxia studies in the range of 70 - 100% SpO₂ against a laboratory CO-oximeter and ECG monitor.

2 The Masimo SET Technology with LNCS sensors has been validated for no motion accuracy in human blood studies on healthy adult volunteers in induced hypoxia studies in the range of 70 - 100% SpO₂ against a laboratory CO-oximeter and ECG monitor. 1% has been added to the saturation accuracy to account for the effects of fetal hemoglobin. This variation equals plus or minus one standard deviation, which encompasses 68% of the population.

3 The Masimo SET Technology with LNCS sensors has been validated for motion accuracy in human blood studies on healthy adult volunteers in induced hypoxia studies while performing rubbing and tapping motions, at 2 to 4 Hz at an amplitude of 1 to 2 cm and a non-repetitive motion between 1 to 5 Hz at an amplitude of 2 to 3 cm in induced hypoxia studies in the range of 70 - 100% SpO₂ against a laboratory CO-oximeter and ECG monitor. 1% has been added to the saturation accuracy to account for the effects of fetal hemoglobin. This variation equals plus or minus one standard deviation, which encompasses 68% of the population.

4 The Masimo SET Technology has been validated for low perfusion accuracy in bench top testing against a Biotek Index 2 simulator and a Masimo simulator with signal strengths of greater than 0.02% and a % transmission of greater than 5% for saturations ranging from 70 to 100%. This variation equals plus or minus one standard deviation, which encompasses 68% of the population.

5 The Masimo SET Rainbow Technology with Rainbow DC-dc sensors have been validated in human blood on healthy adult volunteers against a laboratory CO-oximeter from 1 - 40% for carboxyhemoglobin and 1 - 15% for methemoglobin. This variation equals plus or minus one standard deviation, which encompasses 68% of the population.

6 SpHb accuracy has been validated on healthy adult male and female volunteers and on surgical patients with light to dark skin pigmentation in the range of 8-17 g/dL SpHb against a laboratory CO-oximeter. This variation equals plus or minus one standard deviation which encompasses 68% of the population. The SpHb accuracy has not been validated with motion or low perfusion.

Non-Invasive Blood Pressure

Technique: Non-invasive oscillometric method

Operating Modes: Automatic and manual

Automatic Intervals: 1, 2, 3, 5, 10, 15, 30 and 60 minute intervals.

Turbocuf: Maximum measurements allowable in a 5 minute period

Pressure Measurement Range:

Systolic: 20 to 260 mmHg

Diastolic: 10 to 220 mmHg

Mean: 13 to 230 mmHg

Static Pressure Accuracy: +/- 3 mmHg

Pulse Rate Range:

Adult: 30 to 200 +/- 5 BPM

Pediatric: 30 to 200 +/- 5 BPM

Neonatal: 35 to 220 +/- 5 BPM

Default Cuff Inflation Pressure:

Adult: 160 mmHg

Pediatric: 120 mmHg

Neonatal: 90 mmHg

Maximum Cuff Inflation Pressure:

Adult: 270 mmHg

Pediatric: 170 mmHg

Neonatal: 130 mmHg

Single Fault Backup Overpressure Limit:

Adult: 308 mmHg

Pediatric: 205 mmHg

Neonatal: 154 mmHg

Typical Determination time without Artifact:

Measurements on the deflation: 30 to 45 seconds

Measurements on the inflation (SureBP)*: 15 to 30 seconds

* using dual lumen cuffs

Maximum Determination Time - Measurement on the Inflation

Adult: 150 seconds

Pediatric: 120 seconds

Neonatal: 80 seconds

Blood Pressure Validation:

Blood pressure measurements determined with this device are equivalent to those obtained by a trained observer using the cuff/stethoscope auscultation method for adults and pediatric patients and equivalent to an intra-arterial measurement for neonatal patients, within the limits prescribed by the American National Standards Institute (ANSI-AAMI SP10). To receive a copy of the report containing the AAMI SP10 results, contact the ZOLL Technical Service Department.

NIBP Accuracy:

NIBP accuracy has been verified utilizing clinical test methods which have been determined to meet the requirements of EN ISO 81060-2:2012.

Invasive Pressures

Number of Channels: 3

Pressure range: -30 to 300 mmHg

Pressure Accuracy: +/- 2 mmHg or 2% of reading, whichever is greater, plus transducer error.

Pulse Rate Range: 25 to 250 BPM

Pulse Rate Accuracy: +/- 3 BPM, or +/- 3% of value whichever is greater

Pulse Rate Display: Average of last 4 beat-to-beat intervals.

Zero Adjust: + / - 200 mmHg

Transducer:

Sensitivity: 5uV/V/mmHg

Offset: +/- 125 mmHg including transducer offset

Excitation Impedance Range: 150 to 10,000 ohms

Excitation Voltage: 4.75 +/- 0.25 VDC

Connector: 6-pin circular MS3100 series

Connect to:	A	B	C	D	E
Signal Type	Sig (-)	Exc (+)	Sig (+)	Exc (-)	shield

Temperature

Number of Channels: 2

Measurement Range: 0° to 50° C

Accuracy:

± 0.1° C from 10° C to 50° C, plus probe error

± 0.2° C from 0° C to 10° C, plus probe error

Resolution: 0.1° C

Scale: Fahrenheit or Celsius.

Temperature Display Signal: 20Hz, no averaging.

Probe: YSI 400 and 700 series

Mode of Operation: Direct mode

Display: T1, T2, ΔT

Minimum Measurement Time: See the probe's Instructions for Use to obtain minimum measurement times for accurate readings. The Propaq MD does not add any clinically significant time to obtain accurate readings.

Clinical Trial Results for the Biphasic Waveform

The efficacy of the ZOLL Rectilinear Biphasic waveform has been clinically verified during a study of defibrillation of Ventricular Fibrillation (VF) and Ventricular Tachycardia (VT). A feasibility study was performed initially for defibrillation of VF/VT (n=20) on two separate groups of patients to ensure waveform safety and energy selection. Subsequently, a separate, multicenter, randomized clinical trial was performed to verify the waveform's efficacy. A description of this study is provided below. The study was performed using ZOLL defibrillation systems consisting of ZOLL defibrillators, the ZOLL Rectilinear Biphasic waveform, and ZOLL defibrillation electrodes.

Randomized Multicenter Clinical Trial for Defibrillation of Ventricular Fibrillation (VF) and Ventricular Tachycardia (VT)

Overview: The defibrillation efficacy of the ZOLL Rectilinear Biphasic waveform was compared to a monophasic damped sine waveform in a prospective, randomized, multicenter study of patients undergoing ventricular defibrillation for VF/VT during electrophysiological studies, ICD implants, and test. A total of 194 patients were enrolled in the study. Ten patients who did not satisfy all protocol criteria were excluded from the analysis, leaving a study population of 184.

Objectives: The primary goal of this study was to compare the first shock efficacy of the 120 J rectilinear biphasic waveform with a 200 J monophasic waveform. The secondary goal was to compare all shock (three consecutive 120, 150, and 170 joules) efficacy of the rectilinear biphasic waveform with that of a monophasic waveform (three consecutive 200, 300, and 360 joules). A significance level of $p=0.05$ or less was considered statistically significant using Fischer's Exact test. Also, differences between the two waveforms were considered statistically significant when the customary 95% or AHA-recommended 90%¹ confidence interval between the two waveforms was greater than 0%.

Results: The study population of 184 patients had a mean age of 63 ± 14 years. Of these, 143 patients were male. 98 patients were in the biphasic group (ventricular fibrillation/flutter, n=80; ventricular tachycardia, n=18) and 86 patients were in the monophasic group (ventricular fibrillation/flutter, n=76; ventricular tachycardia, n=10). There were no adverse events or injuries related to the study.

The first shock, first induction efficacy of biphasic shocks at 120 J was 99% versus 93% for monophasic shocks at 200 J ($p=0.0517$, 95% confidence interval of the difference of -2.7% to 16.5% and 90% confidence interval of the difference of -1.01% to 15.3%).

	Monophasic	Biphasic
First shock efficacy	93%	99%
p-value	0.0517	
95% confidence interval	-2.7% to 16.5%	
90% confidence interval	-1.01% to 15.3%	

1. Kerber RE, et al., "Automated External Defibrillators for Public Access Defibrillation: Recommendations for Specifying and Reporting Arrhythmia Analysis Algorithm Performance, Incorporating New Waveforms, and Enhancing Safety," *Circ J Am Heart Assoc.* 1997;95:1677-1682.

"... the task force suggests that to demonstrate superiority of an alternative waveform over standard waveforms, the upper boundary of the 90% confidence interval of the difference between standard and alternative waveforms must be <0% (ie, alternative is greater than standard)."

Successful defibrillation with rectilinear biphasic shocks was achieved with 58% less delivered current than with monophasic shocks (14±1 amperes versus 33±7 amperes, p=0.0001).

The difference in efficacy between the rectilinear biphasic and the monophasic shocks was greater in patients with high transthoracic impedance (greater than 90 ohms). The first shock, first induction efficacy of biphasic shocks was 100% versus 63% for monophasic shocks for patients with high impedance (p=0.02, 95% confidence interval of the difference of -0.0217% to 0.759% and 90% confidence interval of the difference of 0.037% to 0.706%).

	Monophasic	Biphasic
First shock efficacy (high impedance patients)	63%	100%
p-value	0.02	
95% confidence interval	-0.021% to 0.759%	
90% confidence interval	0.037% to 0.706%	

A single patient required a second biphasic shock at 150 joules to achieve 100% efficacy versus six patients for whom monophasic shocks of up to 360 joules were required for 100% total defibrillation efficacy.

Conclusion: The data demonstrate the equivalent efficacy of low energy rectilinear biphasic shocks compared to standard high energy monophasic shocks for transthoracic defibrillation for all patients at the 95% confidence level. The data also demonstrate the superior efficacy of low energy rectilinear biphasic shocks compared to standard high energy monophasic shocks in patients with high transthoracic impedance at the 90% confidence level. There were no unsafe outcomes or adverse events due to the use of rectilinear biphasic waveform.

Randomized Multi-Center Clinical trial for Cardioversion of Atrial Fibrillation (AF)

Overview: The defibrillation efficacy of ZOLL's Rectilinear Biphasic Waveform was compared to a monophasic damped sine waveform in a prospective randomized multi-center study of patients undergoing cardioversion of their atrial fibrillation. A total of 173 patients entered the study. Seven (7) patients who did not satisfy all protocol criteria were excluded from the analysis. ZOLL disposable gel electrodes with surface areas of 78 cm² (anterior) and 113 cm² (posterior) were used exclusively for the study.

Objective: The primary goal of the study was to compare the total efficacy of four consecutive rectilinear biphasic shocks (70J, 120J, 150J, 170J) with four consecutive monophasic shocks (100J, 200J, 300J, 360J). The significance of the multiple shocks efficacy was tested statistically via two procedures, the Mantel-Haenszel statistic and the log-rank test, significance level of p=0.05 or less was considered statistically significant. The data are completely analogous to the comparison of two “survival” curves using a life-table approach where shock number plays the role of time.

The secondary goal was to compare the first shock success of rectilinear biphasic and monophasic waveforms. A significance level of p=0.05 or less was considered statistically significant using Fisher Exact tests. Also, differences between the two waveforms were considered statistically significant when the 95% confidence interval between the two waveforms was greater than 0%.

Results: The study population of 165 patients had a mean age of 66 ± 12 years with 116 male patients.

The total efficacy of consecutive rectilinear biphasic shocks was significantly greater than that of monophasic shocks. The following table displays the Kaplan-Meier (product-limit) “survival” curves for each of the two waveforms. As all patients begin in the failure mode, the estimated life-table probabilities refer to the chance of still being in failure after the k^{th} shock ($k=1,2,3,4$):

Table A-3. Kaplan-Meier Estimate for the Probability of Shock Failure

Shock #	Biphasic	Monophasic
0	1.000	1.000
1	0.318	0.792
2	0.147	0.558
3	0.091	0.324
4	0.057	0.208

As can be seen from the table, the Biphasic experience is superior over the entire course of shocks delivered. The one degree of freedom chi-square statistic for the Mantel-Haenszel test is 30.39 ($p < 0.0001$). Similarly, the log-rank test, also a one degree of freedom chi-square statistic, is 30.38 ($p < 0.0001$). The residual number of patients not successfully treated after four shocks is 5.7% for biphasic compared to 20.8% for monophasic.

There was a significant difference between the first shock efficacy of biphasic shocks at 70J of 68% and that of monophasic shocks at 100J of 21% ($p = 0.0001$, 95% confidence interval of the difference of 34.1% to 60.7%).

Successful cardioversion with rectilinear biphasic shocks was achieved with 48% less delivered current than with monophasic shocks (11 ± 1 vs. 21 ± 4 A, $p < 0.0001$).

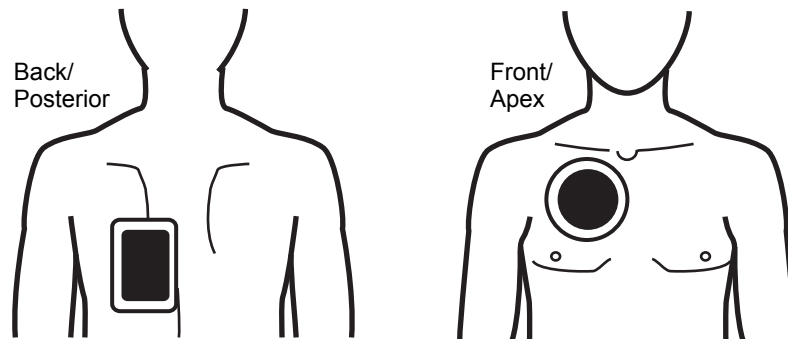
One half of the patients who failed cardioversion after four consecutive escalating monophasic shocks were subsequently successfully cardioverted using a biphasic shock at 170J. No patient was successfully cardioverted using a 360J monophasic shock after the patient had failed cardioversion with biphasic shocks.

Conclusion: The data demonstrate the superior efficacy of low energy rectilinear biphasic shocks compared to high energy monophasic shocks for transthoracic cardioversion of atrial fibrillation. There were no unsafe outcomes or adverse events due to the use of Rectilinear Biphasic Waveform.

Synchronized Cardioversion of Atrial Fibrillation

Cardioversion of atrial fibrillation (AF) and overall clinical effectiveness is enhanced by proper pad placement. Clinical studies (refer to above) of the M Series Biphasic Defibrillator Waveform demonstrated that high conversion rates are achieved when defibrillation pads are placed as shown in the following diagram.

Recommended Anterior/Posterior Placement



Place the front (apex) pad on the third intercostal space, mid clavicular line on the right anterior chest. The back/posterior pad should be placed in the standard posterior position on the patient's left as shown.

Electromagnetic Compatibility Guidance and Manufacturer's Declaration

In-Flight Use (RTCA/DO-160):

The Propaq MD unit complies with RTCA/DO-160, Environmental Conditions and Test Procedures for Airborne Equipment, using the methods in Section 21, Category M for Radiated and Conducted Radio Frequency Energy.


Guidance and manufacturer's declaration – electromagnetic emissions		
The Propaq MD unit is intended for use in the electromagnetic environment specified below. The customer or the user of the Propaq MD unit should assure that it is used in such an environment.		
Emissions test	Compliance	Electromagnetic environment – guidance
RF Emissions CISPR 11	Group 1	The Propaq MD unit uses RF energy only for its internal function. Therefore, its RF emissions are very low and are not likely to cause any interference in nearby electronic equipment.
RF emissions CEM 11	Class B	The Propaq MD unit is suitable for use in all establishments, including domestic establishments and those directly connected to the public low-voltage power supply network that supplies buildings used for domestic purposes.
Harmonic emission IEC 6100-3-2	Class A	
Voltage fluctuations/ flicker emissions IEC 61000-3-3	Complies	
Medical Electrical Equipment needs special precautions regarding EMC and needs to be installed and put into service according to EMC information provided in this document.		

Electromagnetic Immunity (IEC 60601-1-2)

Guidance and manufacturer's declaration – electromagnetic immunity			
The Propaq MD unit is intended for use in the electromagnetic environment specified below. The customer or the user of the Propaq MD should assure that it is used in such an environment.			
Immunity test	IEC 60601 test level	Compliance level	Electromagnetic environment – guidance
Electrostatic discharge (ESD) IEC 61000-4-2	± 6 kV contact ± 8 kV air	± 6 kV contact ± 8 kV air	Floors should be wood, concrete or ceramic tile. If floors are covered with synthetic material, the relative humidity should be at least 30%.
Electrical fast transient / burst IEC 61000-4-4	± 2 kV for power supply lines ± 1 kV for input/output lines	± 2 kV for power supply lines ± 1 kV for input/output lines	Mains power quality should be that of a typical commercial or hospital environment.
Surge IEC 61000-4-5	± 1 kV line(s) to line(s) ± 2 kV line(s) to earth	± 1 kV differential mode ± 2 kV common mode	Mains power quality should be that of a typical commercial or hospital environment.
Voltage dips, short interruptions and voltage variations on power supply input lines IEC 61000-4-11	<5% U_T (>95% dip in U_T) for 0.5 cycle 40% U_T (60% dip in U_T) for 5 cycles 70% U_T (30% dip in U_T) for 25 cycles <5% U_T (>95% dip in U_T) for 5 sec	<5% U_T (>95% dip in U_T) for 0.5 cycle 40% U_T (60% dip in U_T) for 5 cycles 70% U_T (30% dip in U_T) for 25 cycles <5% U_T (>95% dip in U_T) for 5 sec	Mains power quality should be that of a typical commercial or hospital environment. If the user of the Propaq MD unit requires continued operation during power mains interruptions, it is recommended that the Propaq MD unit be powered from an uninterruptible power supply or a battery.
Power frequency (50/60 Hz) magnetic field IEC 61000-4-8	3 A/m	3 A/m	Power frequency magnetic fields should be at levels characteristic of a typical location in a typical commercial or hospital environment.
Note: U_T is the AC mains voltage prior to application of the test level.			

Electromagnetic Immunity: Life-Supporting Functions

Life-supporting functions of the Propaq MD include: ECG waveform monitoring from leads or pads, the pacing pulse output, QRS detection, defibrillation energy discharge, and shock advisory functions.

Guidance and manufacturer's declaration – electromagnetic immunity – for life-supporting equipment and systems			
The life-supporting functions of the Propaq MD are intended for use in the electromagnetic environment specified below. The customer or user of the Propaq MD should ensure that it is used in such an environment.			
Immunity test	IEC 60601 test level	Compliance level	Electromagnetic environment – guidance
Conducted RF IEC 61000-4-6	3 Vrms 150 kHz to 80 MHz outside ISM bands ^a	3 Vrms	Portable and mobile RF communications equipment should be used no closer to any part of the Propaq MD, including cables, than the recommended separation distance calculated from the equation applicable to the frequency of the transmitter. Recommended separation distance $d = 1.2 \sqrt{P}$ $d = 1.2 \sqrt{P}$
	10 Vrms 150 kHz to 80 MHz in ISM bands ^a	10 Vrms	
Radiated RF IEC 61000-4-3	10 V/m 80 MHz to 2.5 GHz	10 V/m	$d = 1.2 \sqrt{P}$ 80 MHz to 800 MHz $d = 2.3 \sqrt{P}$ 800 MHz to 2.5 GHz where P is the maximum output power rating of the transmitter in watts according to the transmitter manufacturer and d is the recommended separation distance in meters. ^b Field strengths from fixed RF transmitters, as determined by electromagnetic site survey, ^c should be less than the compliance level in each frequency range. ^d Interference may occur in the vicinity of equipment marked with the following symbol: 
NOTE 1: At 80 MHz and 800 MHz, the higher frequency range applies.			
NOTE 2: These guidelines may not apply in all situations. Electromagnetic propagation is affected by absorption and reflection from structures, objects, and people.			

a. The ISM (industrial, scientific, and medical) bands between 150 kHz and 80 MHz are 6.765 MHz to 6.795 MHz; 13.553 MHz to 13.567 MHz; 26.957 MHz to 27.283 MHz; and 40.66 MHz to 40.70 MHz.


b. The compliance levels in the ISM frequency bands between 150 kHz and 80 MHz and in the frequency range 80 MHz to 2.5 GHz are intended to decrease the likelihood that mobile/portable communications equipment could cause interference if it is inadvertently brought into patient areas. For this reason, an additional factor of 10/3 is used in calculating the recommended separation distance for transmitters in these frequency ranges.

c. Field strengths from fixed transmitters, such as base stations for radio (cellular/cordless) telephones and land mobile radios, amateur radio, AM and FM radio broadcast and TV broadcast cannot be predicted theoretically with accuracy. To assess the electromagnetic environment due to fixed RF transmitters, an electromagnetic site survey should be considered. If the measured field strength in the location in which the Propaq MD is used exceeds the applicable RF compliance level above, the Propaq MD should be observed to verify normal operation. If abnormal performance is observed, additional measures may be necessary, such as reorienting or relocating the Propaq MD.

d. Over the frequency ranges 150 kHz to 80 MHz field strength should be less than 10 V/m.

Electromagnetic Immunity: Non Life-Supporting Functions

Non life-supporting functions of the Propaq MD include: 12-lead ECG, EtCO₂, SpO₂, SPCO, SpMet, NIBP, IBP, Temp, Impedance Respiration.

Guidance and manufacturer's declaration – electromagnetic immunity – for non-life supporting equipment and systems			
The non life-supporting functions of the Propaq MD are intended for use in the electromagnetic environment specified below. The customer or user of the Propaq MD should ensure that it is used in such an environment.			
Immunity test	IEC 60601 test level	Compliance level	Electromagnetic environment – guidance
Conducted RF IEC 61000-4-6	3 Vrms 150 kHz to 80 MHz ^a	3 Vrms	Portable and mobile RF communications equipment should be used no closer to any part of the Propaq MD, including cables, than the recommended separation distance calculated from the equation applicable to the frequency of the transmitter. Recommended separation distance $d = 1.2 \sqrt{P}$ $d = 1.2 \sqrt{P}$ 80 MHz to 800 MHz $d = 2.3 \sqrt{P}$ 800 MHz to 2.5 GHz $d = 0.35 \sqrt{P}$ 80 MHz to 800 MHz $d = 0.7 \sqrt{P}$ 800 MHz to 2.5 GHz where P is the maximum output power rating of the transmitter in watts according to the transmitter manufacturer and d is the recommended separation distance in meters. Field strengths from fixed RF transmitters, as determined by electromagnetic site survey, ^a should be less than the compliance level in each frequency range. ^b Interference may occur in the vicinity of equipment marked with the following symbol: 
Radiated RF IEC 61000-4-3 (IBP)	3 V/m 80 MHz to 2.5 GHz	3 V/m	
Radiated RF IEC 61000-4-3 (all other non-life supporting functions)	3 V/m 80 MHz to 2.5 GHz	10V/m	
NOTE 1: At 80 MHz and 800 MHz, the higher frequency range applies.			
NOTE 2: These guidelines may not apply in all situations. Electromagnetic propagation is affected by absorption and reflection from structures, objects, and people.			

a. Field strengths from fixed transmitters, such as base stations for radio (cellular/cordless) telephones and land mobile radios, amateur radio, AM and FM radio broadcast and TV broadcast cannot be predicted theoretically with accuracy. To assess the electromagnetic environment due to fixed RF transmitters, an electromagnetic site survey should be considered. If the measured field strength in the location in which the Propaq MD is used exceeds the applicable RF compliance level above, the Propaq MD should be observed to verify normal operation. If abnormal performance is observed, additional measures may be necessary, such as reorienting or relocating the Propaq MD.

b. Over the frequency ranges 150 kHz to 80 MHz field strength should be less than 3 V/m.

Recommended Separation Distances from RF Equipment for the Propaq MD Life-Supporting Functions

Life-supporting functions of the Propaq MD include: ECG waveform monitoring from leads or pads, the pacing pulse output, QRS detection, defibrillation energy discharge, and shock advisory functions.

Recommended separation distances between portable and mobile RF communications equipment and the Propaq MD				
The life-supporting functions of the Propaq MD are intended for use in the electromagnetic environment in which radiated RF disturbances are controlled. The customer or user of the Propaq MD can help prevent electromagnetic interference by maintaining a minimum distance between portable and mobile RF communications equipment (transmitters) and the Propaq MD as recommended below, according to the maximum output power of the communications equipment.				
Rated maximum output power of equipment (in watts)	Separation distance according to frequency of transmitter (in meters)			
	150 kHz to 80 MHz outside ISM bands	150 kHz to 80 MHz in ISM bands	80 MHz to 800 MHz	800 MHz to 2.5 GHz
	$d=1.2 \sqrt{P}$	$d=1.2 \sqrt{P}$	$d=1.2 \sqrt{P}$	$d=2.3 \sqrt{P}$
0.01	0.12	0.12	0.12	0.23
0.1	0.38	0.38	0.38	0.73
1	1.2	1.2	1.2	2.3
10	3.8	3.8	3.8	7.3
100	12	12	12	23
<p>For transmitters rated at a maximum output power not listed above, the recommended separation distance d in meters can be determined using the equation applicable to the frequency of the transmitter, where P is the maximum output power rating of the transmitter in watts according to the transmitter manufacturer.</p> <p>NOTE 1: At 80 MHz and 800 MHz, the separation distance for the higher frequency range applies.</p> <p>NOTE 2: The ISM (industrial, scientific, and medical) bands between 150 kHz and 80 MHz are 6.765 MHz to 6.795 MHz; 13.553 MHz to 13.567 MHz; 26.957 MHz to 27.283 MHz; and 40.66 MHz to 40.70 MHz.</p> <p>NOTE 3: An additional factor of 10/3 is used in calculating the recommended separation distances for transmitters in the ISM frequency bands between 150 kHz and 80 MHz and in the frequency range 80 MHz to 2.5 GHz to decrease the likelihood that mobile/portable communications equipment could cause interference if it is inadvertently brought into patient areas.</p> <p>NOTE 4: These guidelines may not apply in all situations. Electromagnetic propagation is affected by absorption and reflection from structures, objects, and people.</p>				

Recommended Separation Distances from RF Equipment for the Propaq MD IBP Non Life-Supporting Function

Non life-supporting functions of the Propaq MD include: 12-lead ECG, EtCO₂, SpO₂, SPCO, SpMet, NIBP, IBP, Temp, Impedance Respiration.

Recommended separation distances between portable and mobile RF communications equipment and the Propaq MD			
The non life-supporting functions of the Propaq MD are intended for use in the electromagnetic environment in which radiated RF disturbances are controlled. The customer or user of the Propaq MD can help prevent electromagnetic interference by maintaining a minimum distance between portable and mobile RF communications equipment (transmitters) and the Propaq MD as recommended below, according to the maximum output power of the communications equipment.			
Rated maximum output power of equipment (in watts)	Separation distance according to frequency of transmitter (in meters)		
	150 kHz to 80 MHz $d = 1.2 \sqrt{P}$	80 MHz to 800 MHz $d = 1.2 \sqrt{P}$	800 MHz to 2.5 GHz $d = 2.3 \sqrt{P}$
0.01	0.12	0.12	0.23
0.1	0.38	0.38	0.73
1	1.2	1.2	2.3
10	3.8	3.8	7.3
100	12	12	23
For transmitters rated at a maximum output power not listed above, the recommended separation distance d in meters can be determined using the equation applicable to the frequency of the transmitter, where P is the maximum output power rating of the transmitter in watts according to the transmitter manufacturer. NOTE 1: At 80 MHz and 800 MHz, the separation distance for the higher frequency range applies. NOTE 2: These guidelines may not apply in all situations. Electromagnetic propagation is affected by absorption and reflection from structures, objects, and people.			

ECG Analysis Algorithm Accuracy

Sensitivity and specificity are expressions of ECG analysis algorithm performance when compared to ECG interpretation by a clinician or expert. Sensitivity refers to the algorithm's ability to correctly identify shockable rhythms (as a percentage of the total number of shockable rhythms). Specificity refers to the algorithm's ability to correctly identify non-shockable rhythms (as a percentage of the total number of non-shockable rhythms). The data in the following table summarizes the accuracy of the ECG analysis algorithm as tested against ZOLL's ECG Rhythm Database.

The algorithm sequence takes approximately 9 seconds and proceeds as follows:

- Divides the ECG rhythm into three-second segments.
- Filters and measures noise, artifact, and baseline wander.
- Measures baseline content ('waviness' at the correct frequencies — frequency domain analysis) of signal.
- Measures QRS rate, width, and variability.
- Measures amplitude and temporal regularity ('auto-correlation') of peaks and troughs.
- Determines if multiple 3 second segments are shockable then displays *SHOCK ADVISED* message.

Clinical Performance Results

The performance of the incorporated analysis algorithm in a single analysis sequence satisfies the applicable requirements specified in ANSI/AAMI DF80 (section 6.8.3) and the recommendations by Kerber et al. (Circulation. 1997;95(6):1677).

Table A-4. Clinical Performance Results with Standard Analysis Algorithm

Rhythms	Sample Size	Performance Goals	Observed Performance	90% One-sided Lower Confidence Limit
Shockable		Sensitivity		
Coarse VF	536	>90%	>99%	>99%
Rapid VT	80	>75%	>99%	>96%
Non-shockable		Specificity		
NSR	2210	>99%	>99%	>99%
AF, SB, SVT, Heart block, idioventricular, PVCs	819	>95%	>99%	>99%
Asystole	115	>95%	>99%	>97%
Intermediate			Sensitivity	
Fine VF	69	Report only	>89%	>81%
Other VT	28	Report only	>96%	>84%

Table A-5. Clinical Performance Results with ExpressShock

Rhythms	Sample Size	Performance Goals	Observed Performance	90% One-sided Lower Confidence Limit
Shockable		Sensitivity		
Coarse VF	342	>90%	>98%	>97%
Rapid VT	58	>75%	>98%	>94%
Non-shockable		Specificity		
NSR	419	>99%	>99%	>99%
AF, SB, SVT, Heart block, idioventricular, PVCs	1631	>95%	>99%	>98%
Asystole	841	>95%	>99%	>99%
Intermediate			Sensitivity	
Fine VF	50	Report only	>92%	>82%
Other VT	51	Report only	>98%	>91%

References:

Young KD, Lewis RJ: "What is confidence? Part 2: Detailed definition and determination of confidence intervals". Annals of Emergency Medicine, September 1997; 30; 311-218

William H. Beyer, Ph.D.: "CRC Standard Mathematical Tables 28th Edition," CRC Press, Inc, Boca Raton, FL., 1981, Percentage Points, F-Distribution Table, pg 573.

Shock Conversion Estimator

Use of a defibrillator shock is currently the best option for terminating ventricular fibrillation and restoring a life sustaining ECG rhythm [1]. Maintaining blood flow through the heart via cardiopulmonary resuscitation (CPR) has been shown to improve the chances of a successful defibrillation [1]. The cessation of blood flow through the heart that occurs when CPR is stopped decreases the likelihood of a successful shock in proportion to the amount of time that has elapsed without CPR [1]. The repeated use of defibrillator shocks that do not restore a life sustaining rhythm may cause additional damage to the myocardium and reduce the patient's chances for survival. The use of an accurate shock outcome predictor can help reduce the duration of CPR interruptions and the number of ineffective (non-converting) shocks delivered.

Properly performed CPR has been shown to increase blood flow to the heart and increase the neurologically intact patient survival rate [2]. The rescuer must stop CPR while the patient's rhythm is analyzed to determine whether it is shockable. If the rhythm can be identified as unlikely to convert, CPR can be resumed faster rather than delivering ineffective shocks. This reduction in total shocks delivered reduces the damage sustained by the heart during resuscitation.

The Shock Conversion Estimator (SCE) is applied to the analysis result. SCE computes a Shock Prediction Index (SPI) number which measures the probability that a shockable rhythm will be successfully converted by immediate defibrillation. The SPI number is directly related to the AMSA measure developed by the Weil Institute of Critical Care Medicine [3].

The Shock Conversion Estimator algorithm was developed and tested using data collected from a registry of ZOLL AED Pro® and AED Plus® defibrillator field cases. Since the AED Pro and AED Plus defibrillators are first responder units, all patient records correspond to first responder cardiac arrest situations. The defibrillator shock results from these cases were annotated as “converted” if a transient return of spontaneous circulation (tROSC) occurred following the shock. tROSC was defined as post shock ECG rhythms meeting both of the following characteristics:

1. Spontaneous ECG rhythms lasting at least 30 seconds that began within 60 seconds after shock delivery; and
2. Rhythms exhibiting a heart rate of 40 beats per minute or more.

The post shock rhythm was annotated as “non-converted” if it exhibited any other conversion outcome, e.g. VF, VT, and asystole.

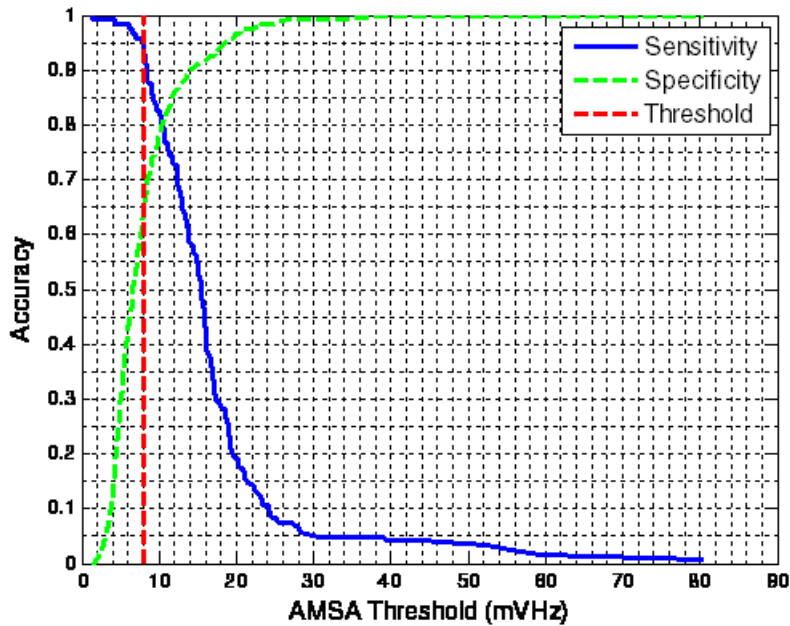
The total database consisted of 258 patient records containing 586 shocks. The first 109 patient records were used in the Validation Database which consisted of 251 delivered shocks. The Development Database was constructed from the remaining patient records, 149 patients, resulting in 335 delivered shocks. The Development Database was used to develop the algorithm and the Test Database was used to validate the performance of the algorithm.

The figure below presents the sensitivity and specificity curves for the combined datasets. The vertical line indicates the position of the 7.9 mV-Hz threshold. 7.9 mV-Hz correlates to a sensitivity and specificity of 95% and 63%, respectively.

The preferred treatment for non-converting rhythms may be the delivery of aggressive CPR. The use of the SPI measure to determine when shock treatments are likely to succeed will help minimize time between the advisory decision and the start of CPR. Minimizing non-perfusing time during resuscitation is a key contributor to improving patient outcomes [4].

$$\text{Sensitivity} = \frac{\text{Number of ECG Rhythms with SPI} > \text{Threshold that were successfully converted}}{\text{Total number of ECG rhythms that were successfully converted}}$$

$$\text{Specificity} = \frac{\text{Number of ECG rhythms with SPI} \leq \text{Threshold that did not convert}}{\text{Total number of ECG rhythms that did not convert}}$$



Sensitivity and Specificity Curves vs. SPI (mV-Hz) for the Combined Database

References:

[1] Eftestol T, Sunde K, Steen PA. Effects of Interrupting Precordial Compressions on the Calculated Probability of Defibrillation Success during Out-of-Hospital Cardiac Arrest. *Circulation* 2002; 105:2270-2273.

[2] Sota Y, Weil MH, Sun S, Tang W, Xie J, Noc M, Bisera J. Adverse effects of interrupting precordial compression during cardiopulmonary resuscitation. *Critical Care Medicine* 1997; 25:733-736.

[3] Young C, Bisera J, Gehman S, Snyder D, Tang W, Weil MH. Amplitude spectrum area: measuring the probability of successful defibrillation as applied to human data. *Critical Care Medicine* 2004; 32:S356-S358.

[4] Wik L. Rediscovering the importance of chest compressions to improve the outcome from cardiac arrest. *Resuscitation* 2003; 58:267-269.

Wireless Output Guidance and Manufacturer's Declaration

RF Transmission Emitted (IEC 60601-1-2)

The Propaq MD unit complies with IEC 60601-1-2 for medical electrical equipment and medical electrical systems that include RF transmitters as specified below.

Standard	Frequency Range	Effective Radiated Power	Modulation Type	Data Rates
802.11b	2412-2472 MHz	100 mW	DSSS	1, 2, 5.5, 11 Mbps
802.11g	2412-2472 MHz	32 mW	OFDM	6, 9, 12, 24, 36, 48, 54 Mbps
802.11n	2412-2472 MHz	32 mW	OFDM	6.5, 13, 19.5, 26, 39, 52, 58.5, 65 Mbps
Bluetooth	2400-2483.5 MHz	10 mW	FHSS; GFSK/ DQPSK/8DPSK	1, 3 Mbps
802.11a	5180-5320 MHz 5500-5700 MHz 5745-5825 MHz	32 mW	OFDM	6, 9, 12, 24, 36, 48, 54 Mbps
802.11n	5180-5320 MHz 5500-5700 MHz 5745-5825 MHz	32 mW	OFDM	6.5, 13, 19.5, 26, 39, 52, 58.5, 65 Mbps

FCC Notice

ZOLL Medical Corporation has not approved any changes or modifications to this device by the user. Any changes or modifications could void the user's authority to operate the equipment. See 47 CFR Section 15.21.

This device complies with part 15 of the FCC Rules. Operation is subject to the following two conditions: (1) This device may not cause harmful interference, and (2) this device must accept any interference received, including interference that may cause undesired operation. See 47 CFR Section 15.19(a)(3).

The user is cautioned to maintain 20cm (8 inches) of space from the product to ensure compliance with FCC requirements.

This device is limited to indoor use in the 5150MHz to 5250MHz band.

Canada, Industry Canada (IC) Notices

This device complies with Industry Canada license-exempt RSS standard(s). Operation is subject to the following two conditions: (1) this device may not cause interference, and (2) this device must accept any interference, including interference that may cause undesired operation of the device.

Appendix B

Accessories

The following accessories are compatible for use with the Propaq MD unit. To order any of these items, contact your local ZOLL representative.

ECG Accessories
ECG, 3-Lead Cable, AAMI
ECG, 3-Lead Cable, IEC
ECG, 5-Lead Cable, AAMI
ECG, 5-Lead Cable, IEC
ECG, 12-Lead "Breakaway" Patient Cable Complete (Trunk Cable, 4-lead wire set with detachable 6 "V" precordial lead wire set), AAMI
ECG, 12-Lead "Breakaway" Patient Cable Complete (Trunk Cable, 4-lead wire set with detachable 6 "V" precordial lead wire set), IEC
ECG, 4-Lead "Breakaway" Trunk Cable and 4 lead wire set only, AAMI
ECG, 4-Lead "Breakaway" Trunk Cable and 4 lead wire set only, IEC
ECG, Detachable 6 precordial lead wire set for "Breakaway" 12-Lead Patient Cable, AAMI
ECG, Detachable 6 precordial lead wire set for "Breakaway" 12-Lead Patient Cable, IEC

CO₂ Accessories (Oridion Filterlines)
Smart CapnoLine Plus, Non-intubated filterline with O ₂ Delivery, Adult, box of 25
Smart CapnoLine Plus, Non-intubated filterline with O ₂ Delivery, Pediatric, box of 25
FilterLine H Set, Adult/Pediatric, box of 25
FilterLine H Set, Infant/Neonate, box of 25
FilterLine Set, Adult/Pediatric, box of 25
VitaLine H set Adult/Pediatric, box of 25
NIBP Accessories
Hoses
Hose, Infant/Neonate, 8', w/ female luer cuff connector, single lumen
Hose, Adult/Pediatric, 10', w/ "twist lock" cuff connector, dual lumen
Hose, Adult/Pediatric, 5', w/ "twist lock" cuff connector, dual lumen
Reusable Cuffs (Welch Allyn Blood Pressure Flexiport Cuffs)
Neonate #1, 3.3 - 5.6 cm single tube w/ male luer connector, box of 10
Neonate #2, 4.2 - 7.1 cm single tube w/ male luer connector, box of 10
Neonate #3, 5.4 - 9.1 cm single tube w/ male luer connector, box of 10
Neonate #4, 6.9 - 11.7 cm single tube w/ male luer connector, box of 10
Neonate #5, 8.9 - 15.0 cm single tube w/ male luer connector, box of 10
Neonatal Cuff Kit, one each of sizes #1 - #5, single tube w/ male luer connector, bag of 5
Welch Allyn REUSE-07-2MQ Cuff, Infant, 2-Tube, Twist lock connector
Welch Allyn REUSE-08-2MQ Cuff, Small Child, 2-Tube, Twist lock connector
Welch Allyn REUSE-09-2MQ Cuff, Child, 2-Tube, Twist lock connector
Welch Allyn REUSE-10-2MQ Cuff, Small Adult, 2-Tube, Twist lock connector
Welch Allyn REUSE-11-2MQ Cuff, Adult, 2-Tube, Twist lock connector
Welch Allyn REUSE-11L-2MQ Cuff, Adult Long, 2-Tube, Twist lock connector
Welch Allyn REUSE-12-2MQ Cuff, Lg Adult, 2-Tube, Twist lock connector
Welch Allyn REUSE-12L-2MQ Cuff, Lg Adult Long, 2-Tube, Twist lock connector
Welch Allyn REUSE-13-2MQ Cuff, Thigh, 2-Tube, Twist lock connector

SpO₂ Accessories
Rainbow R25, Single use sensor for patients > 30 kg
Rainbow R25-L, Single use sensor for patients < 3kg, > 30 kg
Rainbow R20, Single use sensor for Pediatrics 10 - 50 kg
Rainbow R20-L, Single use sensor for Infants 3 - 10 kg
Rainbow Patient Cable RC-4, 4' Reusable Patient Cable
Rainbow Patient Cable RC-12, 12' Reusable Patient Cable
Rainbow DCI-dc8, 8' Adult Reusable Patient Cable / Sensor
Rainbow DCI-dc12, 12' Adult Reusable Patient Cable / Sensor
Rainbow DCIP-dc8, 8' Pediatric Reusable Patient Cable / Sensor
Rainbow DCIP-dc12, 12' Pediatric Reusable Patient Cable / Sensor
Red DBI-dc8, 8' Reusable Direct Connect Sensor, Masimo Rainbow Set
Rainbow DCI Adult Reusable Patient Cable/Sensor (12 ft)
Rainbow Adult Reusable Sensor (3 ft)
SpO ₂ /SpCO/SpMet Rainbow DCI Adult Reusable Patient Cable/Sensor (12 ft)
Rainbow DCI SC-200 Adult Reusable Finger Sensor (SpHb, SpMet, SpO ₂), 3 ft. Sensor includes 200 SpHb Tests.
Rainbow DCI SC-200 Pediatric Reusable Finger Sensor (SpHb, SpMet, SpO ₂), 3 ft. Sensor includes 200 SpHb Tests.
Rainbow DCI SC-400 Adult Reusable Finger Sensor (SpHb, SpMet, SpO ₂), 3ft. Sensor includes 400 SpHb Tests.
Rainbow DCI SC-400 Pediatric Reusable Finger Sensor (SpHb, SpMet, SpO ₂), 3ft. Sensor includes 400 SpHb Tests.
Rainbow R1-25L Adult Adhesive Sensors - SpHb, SpO ₂ , SpMet box of 10
Rainbow R1-20L Infant Adhesive Sensors - SpHb, SpO ₂ , SpMet box of 10
Rainbow R1-25 Butterfly Adult Adhesive Sensors (SpHb, SpO ₂ , SpMet) box of 10
Rainbow R1-20 Butterfly Pediatric Adhesive Sensors (SpHb, SpO ₂ , SpMet) box of 10
M-LNCS™ ADTX, Adult SpO ₂ adhesive sensor, > 30 kg. Single-patient use only
M-LNCS™ Pdtx-3, Pediatrics SpO ₂ adhesive sensor, 3 ft. cable, 10-50 kg. Single-patient use only
M-LNCS™ NeoPt-3, Neonatal SpO ₂ adhesive sensor, 3 ft. cable, < 1 kg. Single-patient use only
M-LNCS™ Inf-3, Infant SpO ₂ adhesive sensor, 3 ft. cable, 3-20 kg. Single-patient use only

Temperature Accessories
YSI Reusable Adult, Skin Probe
YSI Reusable Pediatric, Skin Probe
YSI Reusable Adult, Esophageal/Rectal
YSI Reusable Pediatric, Esophageal/Rectal
Sensor Adapter Cable for Disposable Probes
YSI Disposable Esophageal/Rectal Probe
YSI Disposable Skin Probe
Defibrillation Accessories
Propaq MD Multifunction Therapy Cable - allows use of disposable multifunction electrodes and ZOLL M Series CCT External and Internal paddles (sold separately)
M Series External Paddles set with controls and built-in pediatric electrodes
ZOLL Sterilizable Internal Handle (black), with Switch, 1.0" spoon, 10' cable (US only) or 7' cable
ZOLL Sterilizable Internal Handle (black), with Switch, 1.6" spoon, 10' cable (US only) or 7' cable
ZOLL Sterilizable Internal Handle (black), with Switch, 2.0" spoon, 10' cable (US only) or 7' cable
ZOLL Sterilizable Internal Handle (black), with Switch, 2.7" spoon, 10' cable (US only) or 7' cable
ZOLL Sterilizable Internal Handle (black), with Switch, 3.0" spoon, 10' cable (US only) or 7' cable
ZOLL Sterilizable Internal Handle (black), without Switch, 1.0" spoon, 10' cable
ZOLL Sterilizable Internal Handle (black), without Switch, 1.6" spoon, 10' cable
ZOLL Sterilizable Internal Handle (black), without Switch, 2.0" spoon, 10' cable
ZOLL Sterilizable Internal Handle (black), without Switch, 2.7" spoon, 10' cable
ZOLL Sterilizable Internal Handle (black), without Switch, 3.0" spoon, 10' cable
ZOLL Defibrillation Gel
ZOLL OneStep cable
ZOLL Multifunction Therapy Cable with CPR-D connector
ZOLL Multifunction Therapy Cable CPRD Adapter
CPR stat-padz HVP Multifunction CPR Electrodes - 8 pair/case
CPR stat-padz HVP Multifunction CPR Electrodes - 1 pair
Electrode, pedi-padz II, NO OVERBOX, single
Electrode, pedi-padz II, NO OVERBOX, 6/case
OneStep Resuscitation Electrode (8 per case)
OneStep Pacing Resuscitation Electrode (8 per case)

OneStep CPR Resuscitation Electrode (8 per case)
OneStep Complete Resuscitation Electrode (8 per case)
OneStep CPR AA Electrode (8 per case)
Electrodes, OneStep Basic, Single, R Series
Electrodes, OneStep Pacing, Single, R Series
Electrodes, OneStep CPR, Single, R Series
Electrodes, OneStep Complete, Single, R Series
Electrodes, OneStep CPR AA, Single
Electrodes, OneStep Pediatric
Electrodes, OneStep Pediatric with CPR
Electrodes, OneStep BASIC, Single
CPR-D•padz One Piece Electrode Pad With Real CPR Help
Electrodes, CPR-D-padz w/o Accessory Kit
Set of 12 electrodes, stat-padz
Single, stat-padz
IBP Accessories
Transducer Interface cable – Abbott
Transducer Interface cable - Edwards
Transducers: 5 μ V/mm Hg, IEC 60601-2-34 and AAMI BP-22 compliant
Compatible IBP Transducers
Abbott Transpac [®] IV
Edwards Truwave [®]
To purchase these transducers, contact your local Abbott or Edwards distributor.
CPR Accessories
CPR-D-padz
CPR-stat-padz
CPRD-to- Multifunction Therapy Cable Adapter
stat-padz
pedi-padz II
OneStep electrodes

Power Accessories
ZOLL SurePower II Rechargeable Battery
SurePower Charger Station
SurePower II Battery Charger Battery Adapter
Auxiliary Power Adapter, 8300-0004
Replacement Power Cord – U.S.
Replacement Power Cord – Japan
Other Accessories
Propaq MD Soft Carrying Case
Propaq MD Backpack
ECG 80 mm Chart Recorder Paper
Cable adapter, USB to Ethernet
Multi-Tech Cell Modem; GSM Version
Multi-Tech Cell Modem; CDMA Version
Pre-Grid Paper
USB Cable Extension
Multi-Tech Cell Modem; GSM Version
Multi-Tech Cell Modem; CDMA Version
Multi-Tech Cell Modem External Antenna Kit, GSM Version
Pre-Grid Paper