



OPERATION MANUAL



EC REP

EMERGO EUROPE
Westervoortsedijk 60
6827 AT Arnhem
The Netherlands



ZOLL International Holding B.V.
Einsteinweg 8A
6662 PW ELST
The Netherlands

CH REP

ZOLL Medical Switzerland A.G.
Boarerstrasse 8
6300, Zug Switzerland

MD

©2024 ZOLL Circulation, Inc. All rights reserved. Thermogard XP, Cool Line, Icy, Quattro, Solex 7, and IVTM are trademarks or registered trademarks of ZOLL Medical Corporation and/or ZOLL Circulation, Inc. All trademarks are the property of their respective owners.

Patent: www.zoll.com/patents

ZOLL Circulation, Inc.
2000 Ringwood Avenue
San Jose CA 95131 USA
+1-408-541-2140 (main)
+1-408-541-1030 (fax)

This page intentionally left blank.

Table of Contents

1. Safety Information	1
Overview.....	1
Definitions of Symbols and Labels Used on the Product and in the Manual.....	1
General Safety Precautions.....	3
Guidance and Manufacturer’s Declaration– Electromagnetic Emissions	4
Electromagnetic Immunity Declaration (EID).....	4
Transportation, Shipping and Storage Conditions.....	8
Ignition of Flammable Anesthetic Mixtures	9
Electrical Hazards	9
Configuration Changes	9
Priming the Saline Circuit	10
Air Entry Into the Tubing Circuit	10
Intraluminal or balloon leakage	10
Interference.....	11
Product Label	11
2. Introduction	13
Use of the System	13
Functional Description	13
Console Components	14
Saline Circuit Diagram	20
Intended Use.....	20
3. Receiving, Inspection, and Assembly	21
Overview.....	21
Inspection for Damage	21
Required Tools.....	21
Unpacking	21
Assembly.....	22
4. Operation	25
Overview.....	25
Operating States	25
User Interface	28
Console Menus	33
T1/T2 Behavior	39
Alarms & Alerts	41
Alerts	41
Alarms.....	42
Your First Case.....	43
What you need.....	43
Preparing the Console for Treatment	44
Setup - Variations	60

Setup Sequence.....	60
Downloading Data After Improper Shutdown.....	61
Ending Treatment.....	65
New Patient – No Power Down.....	68
Disposal of Used Components.....	68
Temperature Trend Data.....	69
Displaying the Temperature Trend Graph.....	69
Temperature Trend Graph.....	70
Setting the Time Scale.....	72
Mechanical Components.....	73
Top Cover.....	73
Display Head Tilt.....	73
Casters.....	74
Hospital Monitor Interface Accessory (HMIA).....	75
Overview.....	75
Operating the HMIA.....	75
Installation.....	78
Data Download.....	81
Troubleshooting.....	81
YSI-400 Temperature vs. Resistance.....	83
5. Alarms and Corrective Actions.....	85
Overview.....	85
Alarms and Corrective Actions.....	85
6. Troubleshooting.....	89
Overview.....	89
Symptoms and Remedies.....	89
Events Requiring Technical Assistance.....	91
7. Maintenance.....	93
Overview.....	93
Safety Precautions.....	93
Scheduled Maintenance.....	93
Unscheduled Maintenance.....	94
8. Warranty and Service.....	99
ZOLL Factory Warranty.....	99
Technical Support and Resources.....	99
Obtaining Service from ZOLL.....	100
Packing and Shipping Instructions.....	100
Disposal of the Console.....	100
9. Specification.....	101
Specifications.....	101

1. Safety Information

Overview

Safety is of primary concern to ZOLL Circulation, Inc. This chapter provides information on safely using the Thermogard XP or Coolgard 3000 system. You must read and understand the information in this chapter before operating the system. Always follow the warnings, cautions, and notes throughout this document.

If you have questions about the safe or effective use of the system, please contact the manufacturer.

Warnings, Cautions, and Notes











This document uses the following conventions to indicate important information:





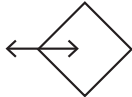















WARNING. Warnings indicate events or conditions that can result in serious injury or death or severe damage to the equipment.





Caution. Cautions indicate information for safe operation, proper performance, or avoiding actions that may result in damage to the equipment.

Note. Notes clarify understanding, aid in the proper operation of the product, and prevent problems or errors from occurring.

Definitions of Symbols and Labels Used on the Product and in the Manual

Symbol	Definition	Symbol	Definition
	Alternating current		Authorized Representative
	Batch Code		Catalog number
	Caution		Caution: Federal law restricts this device to sale by or on the order of a physician.
	CE Mark		Connector for the data acquisition cable
	Consult instructions for use		Danger: Keep hands and fingers away
	Dangerous voltage warning		Date of manufacture

Symbol	Definition	Symbol	Definition
	Do not allow liquids to spill on the product or package.		Do not push or pull on the display head
	Do not re-sterilize		Do not reuse
	Do not stack		Do not use if package is damaged
	Follow instructions for use		Fragile contents
	Fuse	Hi	The high patient temperature alarm limit
	Importer	Lo	The low patient temperature alarm limit
	Manufacturer		Medical device
	MR Unsafe		Off
	On		Potential Equalization Conductor. This is a safety measure to prevent earth current loops in equipment
	Protective earth (ground)		Quantity
	Serial number		Sterile barrier
	Sterilized using irradiation		Swiss authorized representative
	Top facing up		Type B applied part. Defibrillator protected

Symbol	Definition	Symbol	Definition
	Type BF applied part. Defibrillator protected		Unique device identifier
	Use-by date		Weight

General Safety Precautions

WARNING. Systemic hypothermia risks. Systemic hypothermia may cause cardiac arrhythmia, patient shivering, or other system or organ complications. Systemic hypothermia should only be utilized under the supervision of a qualified physician.

When treating a patient with the console, appropriately qualified medical staff must routinely and closely monitor the patient and must comply with the following procedures:

- Audible and visual alarms generated by the console require the authorized individual to remain in close proximity to the patient throughout the procedure.
- Always verify the function of the console prior to insertion of an IVTM catheter. In the event of a malfunction, have other means of cooling available.
- When combining the use of the system and other adjunctive means of cooling, ensure that close observation of the patient is maintained.
- Do not use the system in conjunction with other temperature maintenance devices that have an automatic temperature controller. Temperature oscillations may occur that are dangerous to the patient.
- Performance of installation, operation, or maintenance procedures other than those described in this manual may create hazards and may cause the manufacturer's warranty to become void.
- Sterile components are designed for a single use only. If unauthorized disposable components are used, proper operation cannot be guaranteed and harm to the patient may result.
- Proper aseptic technique must be used while making all sterile connections to the system.
- Never operate damaged or leaking equipment.
- Never operate the equipment without coolant fluid in the coolant well.
- Never use pure water, pure propylene glycol, or alcohol as a coolant fluid.
- Never operate the equipment while smoking or in the presence of open flame.
- Avoid touching the patient simultaneously with metal parts in the console.
- The ZOLL Coolgard and Thermogard consoles are MR Unsafe and, thus, these consoles are not allowed in the MR system room. Therefore, the catheter must be disconnected from the console prior to moving the patient into the MR system room.



WARNING. Projectile hazard.

WARNING. Electric shock risk during cardiac defibrillator discharge. The console's protection against the effect of the discharge of a cardiac defibrillator is partially in the patient temperature probe. To prevent potential hazards to the patient or operator, the console must be used in conjunction with the approved patient temperature probes listed in Specifications section of this manual.

Guidance and Manufacturer's Declaration– Electromagnetic Emissions

The Thermogard XP console is intended for use in the electromagnetic environment specified below. The customer or user of the console should ensure that it is used in such an environment.		
Emissions test	Compliance	Electromagnetic Environment Guidance
RF Emissions CISPR 11	Group 1	The Thermogard XP console uses RF energy for its internal function only. Therefore, its RF emissions are very low and are not likely to cause any interference in nearby equipment.
RF Emissions CISPR 11	Class A	The console is suitable for use in all establishments other than domestic establishments and those directly connected to a low-voltage power supply network that supplies buildings used for domestic purposes. Note. The emissions characteristics of this equipment make it suitable for use in industrial areas and hospitals (CISPR 11 Class A). If it is used in a residential environment (for which CISPR B is normally required), this equipment might not offer adequate protection to radiofrequency communication services. You may need to relocate or re-orient the equipment.
Harmonic Emissions IEC 61000-3-2	Class A	
Voltage Fluctuations / Flicker Emissions IEC 61000-3-3	Complies	

Table 1.1. Guidance and Manufacturer's Declaration–Electromagnetic Emissions

Electromagnetic Immunity Declaration (EID)

The Thermogard XP console is intended for use in the electromagnetic environment specified below. The customer or user of the console should ensure that it is used in such an environment.

Immunity Test	IEC 60601 Test Level	Compliance Level	Electromagnetic environment – guidance
Electrostatic discharge (ESD) IEC 61000-4-2	± 8kV contact ± 15 kV air	± 8kV contact ± 15 kV air	Floors should be wood, concrete, or ceramic tile. If floors are covered with synthetic material, the relative humidity should be 30% or higher.
Electrical fast transit/ burst IEC 61000-4-4	±2 kV for power supply lines ±1kV for input/output lines	±2 kV for power supply lines ±1kV for input/output lines	Mains power quality should be that of a typical commercial or hospital environment.
Surge IEC 61000-4-5	±1kV differential mode ±2kV common mode	±1kV differential mode ±2kV common mode	Mains power quality should be that of a typical commercial or hospital environment.

Table 1.2. Guidance and Manufacturer's Declaration – Electromagnetic Immunity

Immunity Test	IEC 60601 Test Level	Compliance Level	Electromagnetic environment – guidance
Voltage dips, short interruptions, and voltage variations on power supply input lines IEC 61000-4-11	Voltage Dips > 95% reduction, 0.5 period At 0°, 45°, 90°, 135°, 180°, 225°, 270° and 315°	Voltage Dips > 95% reduction, 0.5 period At 0°, 45°, 90°, 135°, 180°, 225°, 270° and 315°	Mains power quality should be that of a typical commercial or hospital environment. If you require continued operation during power mains interruptions, we recommend that the console be powered by an uninterruptable power supply or a battery.
	Voltage Dips > 95% reduction, 1 period At 0°	Voltage Dips > 95% reduction, 1 period At 0°	
	Voltage Interruptions > 95% reduction, 250/300 periods	Voltage Interruptions > 95% reduction, 250/300 periods	
Powerfrequency (50/60 Hz) magnetic field IEC 61000-4-8	30 A/m	30 A/m	Power frequency magnetic fields should be at levels characteristic of a typical location in a typical commercial or hospital environment.

Table 1.2. Guidance and Manufacturer’s Declaration – Electromagnetic Immunity

The Thermogard XP console is intended for use in the electromagnetic environment specified below. The customer or user of the console should ensure that it is used in such an environment.

Immunity Test	IEC 60601 Test Level	Compliance Level	Electromagnetic environment guidance
Conducted RF immunity IEC 61000-4-6	3 Vrms 150 kHz to 80 MHz	3 Vrms 150 kHz to 80 MHz	Portable and mobile RF communications equipment should be used no closer to any part of the console, including cables, than the recommended separation distance calculated from the equation applicable to the frequency of the transmitter. Recommended separation distance 150 kHz to 80 MHz $d = 1.2 \sqrt{P}$, 80 to 800 MHz $d = 2.3 \sqrt{P}$, 800 MHz to 2.7 GHz
	6 Vrms in ISM bands within 150 kHz and 80 MHz	6 Vrms in ISM bands within 150 kHz and 80 MHz (see Note 3)	
	80% AM at 1 kHz	80% AM at 1 kHz	

Immunity Test	IEC 60601 Test Level	Compliance Level	Electromagnetic environment guidance
Radiated RF IEC 61000-4-3	3V/m 80 Mhz to 2.7 GHz	3V/m	<p>Where P is the maximum power rating of the transmitter in watts (W) according to the transmitter manufacturer and d is the recommended separation distance in meters (m).</p> <p>Field strengths from fixed RF transmitters, as determined by electromagnetic site survey,¹ should be less than the compliance level in each frequency range.²</p> <p>Interference may occur in the vicinity of equipment marked with the following symbol:</p> 
<p>Note 1. At 80 Mhz and at 800 MHz, the higher frequency range applies.</p> <p>Note 2. These guidelines may not apply in all situations. Electromagnetic propagation is affected by absorption and reflection from structures, objects, and people.</p> <p>Note 3. The frequency range between 100-150 kHz is associated with interference from low frequency RFID equipment.</p> <p>Note 4. The ISM (industrial, scientific and medical) bands between 150 kHz and 80 MHz tested are 6.765 MHz to 6.975 MHz; 13.553 MHz to 13.567 MHz; 26.957 MHz to 27.283 MHz; and 40.66 MHz to 40.70 MHz.</p> <p>Note 5. Tested for immunity to RF interference from transmitters operating at 125 kHz, 134.2 kHz and in the frequency ranges between 3.155 MHz to 3.4 MHz and between 7.4 MHz to 8.8 MHz.</p>			

1. Field strengths from fixed transmitters, such as base stations for radio (cellular/cordless) telephones and land mobile radios, amateur radio, AM and FM radio broadcasts and TV broadcast cannot be predicted theoretically with accuracy. To assess the electromagnetic environment due to fixed RF transmitters, an electromagnetic site survey should be considered. If the measured field strength in the location in which the console is used exceeds the applicable RF compliance level above, the console should be observed to verify normal operation. If abnormal performance is observed, additional measures may be necessary, such as reorienting or relocating the console.
2. Unless otherwise noted, over the frequency ranges 150 kHz to 80 Mhz, field strength should be less than 10 V/m.

Note. The following degradation associated with essential performance are not allowed during testing: component failure, changes in programmable parameters, resets to factory defaults, changes in operating modes, false alarms, cessation or interruption of any intended operation, even if accompanied by an alarm, initiation of any unintended operation, including unintended or uncontrolled motion, even if accompanied by an alarm, error of a displayed numerical value sufficiently large to affect diagnosis or treatment, noise on a signal in which the noise is indistinguishable from physiologically-produced signals or the noise interferes with interpretation of physiologically-produced signals.

The Thermogard XP console is intended for use in an electromagnetic environment in which radiated RF disturbances are controlled. You can help prevent electromagnetic interference by maintaining a minimum distance between portable and mobile RF communications equipment (transmitters) and the console as recommended below, according to the maximum output power of the communications equipment.

Radiated maximum output power of the equipment (in Watts)	Separation distance according to frequency of transmitter (in meters)			
	150 kHz to 80 MHz outside ISM bands $d = 1.2\sqrt{P}$	150 kHz to 80 MHz inside ISM bands $d = 1.2\sqrt{P}$	80 MHz to 800 MHz $d = 1.2\sqrt{P}$	800 MHz to 2.7 GHz $d = 2.3\sqrt{P}$
0.01	0.12	0.12	0.12	0.23
0.1	0.38	0.38	0.38	0.73
1	1.2	1.2	1.2	2.3
10	3.8	3.8	3.8	7.3
100	12	12	12	23

For transmitters rated at a maximum output power not listed above, the recommended separation distance d in meters can be determined using the equation applicable to the frequency of the transmitter, where P is the maximum output power rating of the transmitter in Watts according to the transmitter manufacturer.

Note 1. At 80 MHz and at 800 MHz, the separation distance for the higher frequency range applies.

Note 2. These guidelines may not apply in all situations. Electromagnetic propagation is affected by absorption and reflection from structures, objects, and people.

Table 1.3. Recommended separation distances between portable and mobile RF communications equipment and the console

Test Frequency (MHz)	Band ¹ (MHz)	Service ¹	Modulation ²	Maximum Power (W)	Distance (m)	Immunity Test Level (V/m)
Equipment: Valid test levels for professional healthcare facility						
385	380 – 390	TETRA 400	Pulse modulation ² 18 Hz	1.8	0.3	27
450	430 – 470	GMRS 460, FRS 460	FM ³ ± 5 kHz deviation 1 kHz sine	2	0.3	28
710	704 – 787	LTE Band 13, 17	Pulse modulation ² 217 Hz	2	0.3	28
745						
780						

Table 1.4. Guidance and Manufacturer Declaration - Immunity to RF Wireless Communications

Test Frequency (MHz)	Band ¹ (MHz)	Service ¹	Modulation ²	Maximum Power (W)	Distance (m)	Immunity Test Level (V/m)
810	800 – 960	GSM 800/900, TETRA 800, iDEN 820, CDMA 850, LTE Band 5	Pulse modulation ² 18 Hz	2	0.3	28
870						
930						
1720	1 700 – 1 990	GSM 1800; CDMA 1900; GSM 1900; DECT; LTE Band 1, 3, 4, 25; UMTS	Pulse modulation ² 217 Hz	2	0.3	28
1845						
1970						
2450	2 400 – 2 570	Bluetooth, WLAN, 802.11b/g/n, RFID 2450, LTE Band 7	Pulse modulation ² 217 Hz	2	0.3	28
5240	5 100 – 5 800	WLAN 802.11 a/n	Pulse modulation ² 217 Hz	0.2	0.3	9
5500						
5785						

Table 1.4. Guidance and Manufacturer Declaration - Immunity to RF Wireless Communications

1. For some services, only the uplink frequencies are included.
2. The carrier shall be modulated using a 50% duty cycle square wave signal.
3. As an alternative to FM modulation, 50% pulse modulation at 18 Hz may be used because while it does not represent actual modulation, it would be worst case.

Transportation, Shipping and Storage Conditions

When shipping or storing the console, follow these recommendations:

- Do not allow liquids to spill on the console or its packaging.
- Keep in a cool, dry place.
- Fragile contents, handle with care.
- Always handle and store with the top facing up.

When transporting the console around the hospital, follow these recommendations:

- Move the console by the handle only; do not push or pull on the display head.
- Request assistance from another person to lift the front wheels of the console when moving it over a threshold. Use handle to gently pull unit over the obstacle while your assistant stabilizes the front of the unit.

WARNING. Tipping hazard. The console may tilt in case of transport outside its crate and over a threshold.

Ignition of Flammable Anesthetic Mixtures

The console is not category AP or APG equipment and must not be used in oxygen-rich environments or environments where flammable anesthetic gas mixtures are present.

Electrical Hazards

This equipment has been tested and found to comply with the EMC limits of the international standard IEC 60601-1-2. These limits are designed to provide reasonable protection against interference in a typical medical installation. The equipment can radiate radio frequency energy if not installed in accordance with the instructions, and may cause harmful interference to other devices in the vicinity. There is no guarantee that interference will not occur in a particular installation. Always comply with the following:

- To avoid the risk of electrical shock, do not remove any panels of the product.
- Refer servicing to qualified personnel.
- Never operate equipment with damaged power line cords.

The Thermogard XP requires special precautions regarding EMC and needs to be installed and put into service according to EMC information provided in this manual.

Portable and mobile RF communications equipment can affect the Thermogard XP.

Caution. Dangerous Voltage. Electric shock hazard. Always turn off the console and disconnect the power line cord from the source before performing any service or maintenance procedures, or before moving the console. To avoid the risk of electric shock, this equipment must be connected to a supply mains with protective earth.

WARNING. The potential equalization conductor should be connected to the potential equalization bus bar of the electrical installation when available. Refer to the requirements in the IEC 60601-1 standard.

Primary Patient Temperature Probe (T1) Failure

The console relies upon the patient temperature reading from an YSI-400 type thermistor connected to the primary patient temperature probe (T1). There are rare failures of this type of thermistor that cannot be detected by the console with 100% reliability. Failure of the T1 can result in either patient hypo- or hyper-thermia. Death or serious injury to the patient may result. A secondary patient temperature probe (T2) connection is therefore built into the console. For patient safety, either use both the T1 and T2 connections or employ the T1 probe with an independent frequent check of patient core temperature.

WARNING. Never clinically use a resistor in place of the T1 temperature probe. ZOLL supplies fixed value resistors and variable resistor test boxes (e.g the TP-400 FOGG Box) for testing, training and demonstration purposes. These can be plugged into the primary patient temperature probe T1 connection on the front of the console to represent a patient. Never use this device, or other method, to circumvent the normal patient temperature feedback control when the console is connected to the patient. Doing so exposes the patient to the hazards associated with hypo- or hyper-thermia. Death or serious injury may result.

Configuration Changes

WARNING. No modification of this equipment is allowed.

Caution. Certification requirements for external equipment connected to the console interfaces. Equipment connected to the analog and digital interfaces must be certified to the respective IEC standards (i.e., IEC 60950 for data processing equipment and IEC 60601-1 for medical equipment). Furthermore, all configurations shall comply with the system standard IEC 60601-1. Any person who connects additional equipment to the signal input part or the signal output part configures a medical system and is therefore responsible that the system complies with the requirements of the system standard IEC 60601-1.

Priming the Saline Circuit

WARNING. Do not prime the saline circuit while connected to a patient. During the priming operation, the air-trap alarm will be disabled. Air present in the saline line may be circulated through the indwelling catheter. Before priming the circuit or during troubleshooting for possible leak, disconnect the heat exchange catheter, then connect the IN and OUT Luers of the saline circuit together.

Air Entry Into the Tubing Circuit

Air entry may occur with the failure of any part of the Start-Up Kit, between the saline bag and the outflow of the pump. In such cases, the integrity of the catheter prevents air entry into the patient. In the rare event of a second, simultaneous failure of the catheter, air entry into the patient is possible.

Air entry into the tubing circuit will usually, but not always, be associated with an air trap alarm that will stop the console. **Always investigate air trap alarms.** The cooling circuit is a closed loop—usually air trap alarms indicate a breach somewhere in this closed loop (occasionally an air trap alarm can be caused by condensation forming on the air trap exterior). With any air trap alarm, check both the integrity of the catheter and the Start-Up Kit (see below).

Periodically check the Start-Up Kit for significant air bubbles and replace the kit if necessary.

Intraluminal or balloon leakage

WARNING. Intraluminal leakage (between the saline lumen and infusion lumens) or balloon leakage is a potential catheter failure mode. In the event of such a failure, sterile saline from the cooling circuit is introduced into the patient. Intraluminal leakage or balloon leakage is typically associated with a fluid loss alarm once the saline bag has been depleted and stops the system. **Always investigate fluid level alarms.** The cooling circuit is a closed loop system – usually fluid loss alarms indicate a breach somewhere in this closed loop. With any fluid loss alarm, check both the integrity of the catheter and the Start-Up Kit (see below).

WARNING. If you notice a depleted saline bag or an air trap alarm, do not replace the saline bag prior to identifying the location of the leak and taking the appropriate mitigation. Check for system leaks according to the instructions in the Check for a Start-Up Kit leak and Check for a catheter leak sections below. (Note that a leak could be external or internal.)

Replacing the saline bag repeatedly without investigating the leak or loss of saline may result in unintended infusion of saline into the patient. Saline infusion may lead to the following adverse effects: local swelling that can cause subsequent local tissue damage; systemic fluid overload that can lead to dependent edema and subsequent skin breakdown; internal organ fluid overload, with subsequent overloading of the brain, lungs or heart. In some cases, this fluid overload may lead to life threatening events.

Caution. The console emits an alarm when the saline bag is empty. The bag must be completely empty and additional saline must have drained between the saline spike and the air trap for the saline level in the air trap to drop sufficiently to trigger the alarm.

Check for a Start-Up Kit leak

1. Check the air trap for condensation. If the air trap shows signs of condensation, wipe the air trap and reinstall it in the console. In the case of an air trap alarm, verify that the air trap alarm is cleared after this step.
2. Carefully check the saline path from the saline bag to the console for any leaks. Check if there is saline on the floor, console, or the patient's bed.
3. If there is any saline on the floor, console, or the patient's bed, check that the Luers on the catheter and Start-Up Kit are not cracked or damaged and that the connections are tight enough to prevent leaks.
4. If you find a leak in the Start-Up Kit, replace the Start-Up Kit and see if there is also a leak in the catheter.
5. If you do not find a leak in the Start-Up Kit, there is likely a leak in the catheter. Investigate further.

Check for a catheter leak

1. Disconnect the Start-Up Kit from the catheter. Properly cap both the catheter and Start-Up Kit using an aseptic technique.
2. Fill a sterile 10 mL slip tip syringe with sterile saline.
3. Connect the syringe to the IN Luer of the catheter and disconnect the OUT cap. Infuse 10 mL of saline – the saline should flow out the OUT Luer. If the saline does not flow out of the OUT Luer, a catheter leak is indicated.
4. Cap the OUT Luer and pull 5 cc of vacuum. Sustain for at least 10 seconds. Up to 4 mL of saline (not blood) should enter the syringe and you should be able to maintain the vacuum. If traces of blood are seen in the syringe or vacuum cannot be maintained, it indicates a catheter leak.
5. If you find a leak in the catheter, replace the catheter.
6. Replace the saline bag and re-prime the Start-Up Kit.
7. Ensure leak-tight Luer connections to the Start-Up Kit and continue the therapy.

WARNING. Never clinically circumvent the air trap alarm. ZOLL may use an air trap simulator fixture for testing, training and demonstration purposes. These are fluid filled air trap assemblies that are separate from a standard Start-Up Kit assembly. Never use this device, or other method, to circumvent the air trap alarm when the console is connected to the patient. Doing so exposes the patient to the hazards associated with air embolism should the catheter fail. Death or serious injury may result.

Interference

If the console does cause interference with other devices, which can be determined by turning the console off and on, try to correct the interference by one or more of the following measures:

- Reorient or relocate the receiving device.
- Increase the separation between the console and device.
- Connect the console into an outlet on a circuit different from that to which the other device(s) is connected.

Product Label

An identifying label is attached to the outside of the console near the power cord inlet.

The label provides safety information and identifies the manufacturer, model, serial number, power requirements, fuse capacity, and manufacturing date for the console.

This page intentionally left blank.

2. Introduction

Use of the System

WARNING. Patients must be continuously monitored. Patients being treated with the system must be checked frequently (hourly) when the system is operating. It is possible for malfunctions or misuse of the system to result in patient injury or death.

The ZOLL Intravascular Temperature Management (IVTM™) System is comprised of an external heat exchange console (Thermogard XP® console) and an IVTM™ endovascular heat-exchange catheter connected via a sterile heat exchanger and tubing circuit (Start-Up Kit). These components together comprise a patient temperature-regulation apparatus employing feedback control. The catheter and the Start-Up Kit are single-use disposable devices.

This manual provides operating instructions for the console and the Start-Up Kit. Catheter components are referenced where it is necessary to ensure proper use with the system components. Always refer to the catheter's Instructions for Use for additional specific information.

Operating Life

The operating life of the catheters may vary according to design as indicated by the model designation. Always refer to the catheter's Instructions for Use for information about the catheter's operating life.

The disposable components of the Start-Up Kit are designed for continuous use for a period not to exceed seven (7) days on a single patient. After seven days of use, remove and replace the Start-Up Kit with a new Start-Up Kit.

Caution. Start-Up Kit lifetime is seven days. The designed operating lifetime for Start-Up Kit components is seven (7) days of continuous operation on a single patient. If a patient must be treated for a longer period, a new Start-Up Kit must be installed in the console. Failure to adhere to this time limit may cause injury to the patient.

Product designed for single use only. Do not resterilize or reuse. Do not alter the Start-Up Kit in any way.

Potential risks with re-use of a single use device include but are not limited to:

- Potentially life threatening infection
- Toxic shock due to degradation of materials
- Increased risk of thrombosis
- Reduced heat exchange power
- Device failures

Functional Description

The console can be described in terms of three major components: a recirculating chiller, a roller pump, and a temperature control system. The system is connected to the temperature-controlled catheter by two small-bore plastic tubes. One tube supplies temperature-controlled sterile saline solution to the catheter, and the other tube returns the saline solution to the console. The sterile saline is pumped through a continuous recirculating loop by a roller pump inside the console. The saline solution acts as an intermediate heat-transfer medium between the patient and the console. Sterile saline is used because it is biologically compatible with the patient and in the unlikely event of a leak in the catheter, the possibility of harming the patient is reduced to a practical minimum.

Patient temperature feedback is used to control the console. The patient's temperature is measured by an indwelling YSI-400 thermistor temperature sensor. In response to the patient's measured temperature, the console employs both cooling and heating. Cooling occurs when the patient's temperature is above the set point target temperature. Heating occurs when the patient's temperature is below the set point target temperature. The amount of heating or cooling power is proportional to the difference in temperature between the set point target temperature and the patient's measured temperature.

A basic diagram of the System is illustrated in Figure 2.1.

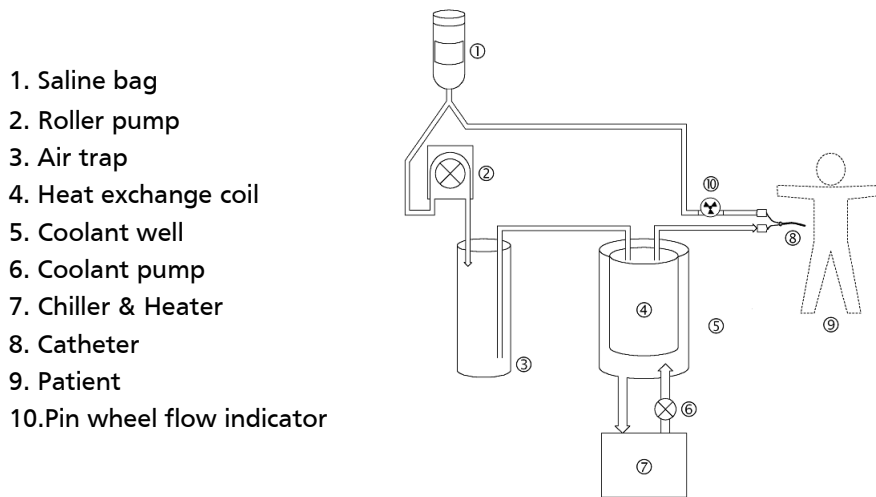

Figure 2.1. Simplified Flow Diagram

Console Components

Controls and Display Screen

The display head contains four buttons and one knob used to access functions and adjust settings with the aid of the menus and messages displayed on the screen. The controls and display screen are illustrated in Figure 2.2 and explained in the following text.

Display Screen

The display screen is a backlit color LCD panel that can be easily read in all ambient lighting conditions. It is used to display status, menus, messages, alarms, and patient temperature trend graphs.

The display head is attached to the mast by an adjustable swivel/tilt mounting clamp. You can adjust the tilt and rotation of the display head and lock it into position by using this clamp.

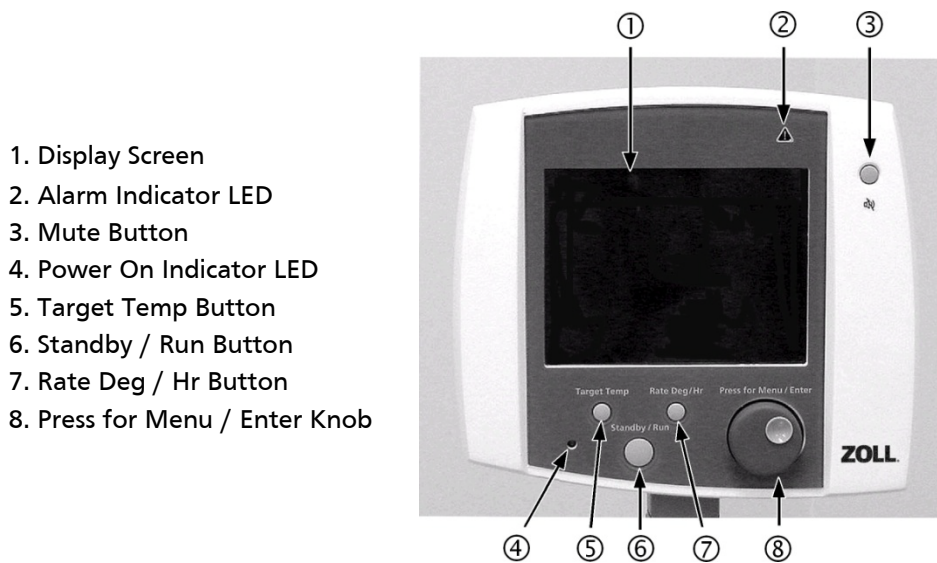

1. Display Screen
2. Alarm Indicator LED
3. Mute Button
4. Power On Indicator LED
5. Target Temp Button
6. Standby / Run Button
7. Rate Deg / Hr Button
8. Press for Menu / Enter Knob

Figure 2.2. Controls and Display Screen

Power Indicators

An indicator lamp on the control panel is illuminated when power is switched on. A second power-on indicator is mounted directly above the power switch on the rear of the console.

Alarm Indicators

The console typically notifies users of alarm conditions in two ways. When an alarm occurs, the screen displays an alarm message, and an alarm annunciator produces an audible alarm tone (beep). You can temporarily mute the alarm tone, but cannot turn it off.

If the nature of the failure prevents the console from displaying an alarm message, the alarm indicator on the control panel will be illuminated.

Control Buttons

The display head features four pushbuttons that are used to control console functions. To provide confirmation, each time a button is pressed, a "key click" sound is produced by the annunciator.

Target Temp

Press the "Target Temp" button to display a screen that allows you to set the patient's target temperature. You may set a target temperature between 31° C and 38° C (87.8° F and 100.4° F).

Rate Deg/Hr

Press the "Rate Deg/Hr" button to display a screen that allows you to set the cooling/warming rate (expressed in degrees per hour). You may set a cooling/ warming rate between 0.10° C/hr and 0.65° C/hr (0.18° F/hr and 1.17° F/hr).

Standby/Run

Press the "Standby/Run" button to toggle the operation of the console between Standby mode (the pump is stopped) or Run mode.

An alarm or fault can place the console into Standby mode automatically. After remedying the condition that caused the alarm, press this button to return to Run mode.

Mute Button

Press the Mute button to silence the audible alarm tone for two minutes (120 seconds). If the alarm condition has not been cleared during this two-minute period, the audible alarm will sound again.

Press for Menu/Enter Knob

The "Press for Menu/Enter" knob is a dual-function control knob and pushbutton.

Press the knob to display a menu screen or to indicate the completion of a selection.

Turn the knob to scroll between selections or to scroll temperature trend graphs.

Serial Interface Connector

A female 9-pin subminiature D connector is mounted on the lower left corner of the rear of the display head. Use this connector to attach a serial interface cable between the console and a laptop computer. Once connected, the computer can download patient temperature trend data stored by the console.

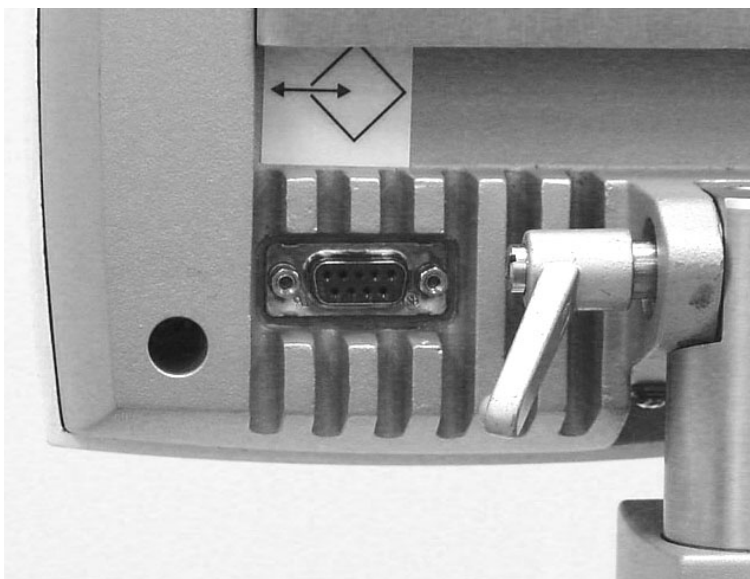

Figure 2.3. Serial Interface Connector

Recirculating Chiller

The chiller consists of an air-cooled refrigeration system, reservoir heater, circulation pump, stainless steel reservoir, reservoir cover, and a temperature controller.

Temperature Controller

The temperature controller uses input from the patient's temperature probe and the operator-selected patient temperature setpoint to regulate the coolant temperature of the recirculating chiller. The temperature controller constantly adjusts the coolant temperature by means of a closed-loop control system. The operator enters a setpoint that represents the patient's target temperature. The controller cools or heats the coolant, in a range between 0° and 42° C (32° and 107.6° F) to optimally achieve and maintain the target temperature. The controller constantly displays the measured patient temperature and the target temperature.

An optional mode can command the controller to approach the target temperature at a user-selected rate.

Temperature Probe Connectors

The front of the console features two connectors, labeled "T1" and "T2" which are used for connection to patient temperature probes. The primary patient temperature probe is plugged into connector T1. The secondary probe is plugged into connector T2.



Figure 2.4. Temperature Probe Connectors.

Roller pump

Sterile saline solution is circulated through the heat exchange coil and the catheter by a high-performance, compact roller pump. It pumps by peristaltic action on the tubing installed in the pump head. The pump rotation speed is accurately controlled by an electronic speed control system.



WARNING. Finger injuries. Be careful when inserting the roller pump tubing that you do not catch your fingers with the roller. When the console is operating, do not attempt to circumvent the safety interlocks on the roller pump lid. Do not place fingers or foreign objects into the pump raceway when the pump is turning. The roller pump has sufficient torque to severely damage a finger.

If a tubing leak or failure occurs in the pump raceway, the saline solution will cause corrosion in the moving parts of the rotor. Contact your ZOLL service representative.



Figure 2.5. Pump

Prime Switch

The prime switch is located on the right side of the pump. The switch is used to operate the pump to prime the tubing with sterile saline solution from the saline source. When the switch is held down, the pump runs; when the switch is released, the pump stops.



Figure 2.6. Prime Switch

Start-Up Kit

The Start-Up Kit contains the sterile disposable components for this system. Each kit contains a heat exchange coil, air trap, saline delivery lines, saline container connector, catheter connectors, and the roller pump tubing. These components are described in detail in later chapters of this document. The components in the Start-Up Kit are designed to operate continuously for seven days, after which it must be replaced.

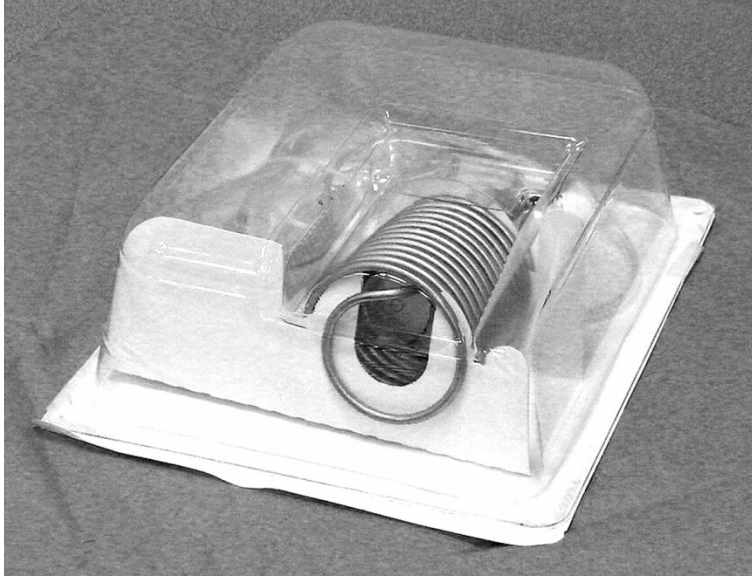

Figure 2.7. Start-Up Kit

Data Memory

The console is capable of continuously recording patient temperature and system activity for up to 21 days. This stored data can be downloaded to an attached computer over a serial interface using optional software furnished by ZOLL.

Saline Circuit Diagram

A flow diagram is printed on the inside of the top cover. Use this diagram to ensure that the Start-Up Kit has been installed correctly.

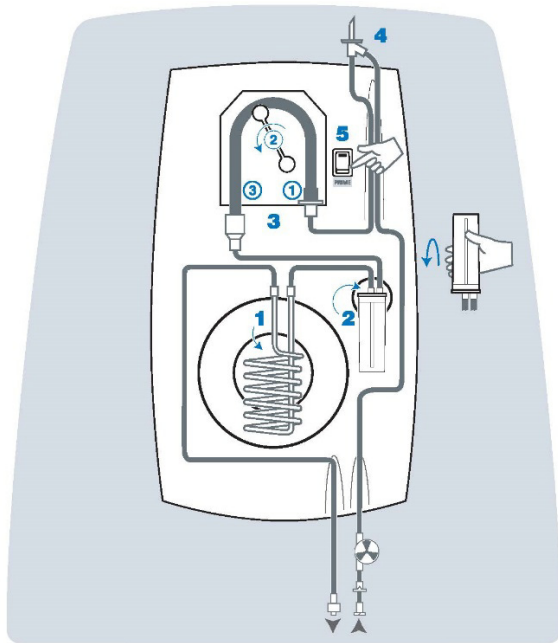

Figure 2.8. Flow Diagram

Intended Use

The intended use for the ZOLL IVTM console and HMIA is as follows:

The ZOLL IVTM consoles in combination with the Cool Line, Icy, Quattro, or Solex model catheters permit circulation of temperature controlled saline through a heat exchanger to cool or rewarm the patient's blood in patients for whom the risks of a central line are warranted.

3. Receiving, Inspection, and Assembly

Overview

This chapter provides information on how to receive, unpack, and assemble the console. If your console was delivered and set up by a ZOLL representative, you may skip this chapter and turn to Chapter 4.

Inspection for Damage

Each console is carefully inspected before it is shipped. When the carrier delivers your console, ensure that the shipping containers are not damaged. Visually inspect the outside of the shipping container for any damage. If damage is detected, please notify ZOLL Customer Service and file a damage claim with the carrier.

Required Tools

To safely unpack, inspect, and assemble the console, you will need the following tools:

- Phillips screwdriver (included in shipping container)
- 3/16-inch Allen wrench (included in shipping container)
- 5/32-inch Allen wrench (included in shipping container)
- 7/64-inch Allen wrench (included in shipping container)
- Scissors or box knife

Unpacking

Caution. Avoid lifting injury. The console weighs 107 lb (49 kg). Never attempt to lift the equipment without assistance. Use safe lifting practice when handling the equipment.

To unpack the console, follow these steps in the indicated order.

1. Remove the straps from the carton and pallet.
2. Open the top flaps of the carton and remove the inner carton containing the display head. This carton also contains the handle, attachment hardware, spare fuses, the condensate pan, the saline container insulating jacket, and other miscellaneous parts.
3. Remove the protective inserts and lift the outer carton up and off.
4. Use scissors or a box knife to carefully cut away the moisture barrier bag surrounding the console. Use care to avoid scratching the console.
5. **With the help of an assistant**, grasp the base of the console just above the casters, carefully lift the console off the platform, and set it on the floor.



Figure 3.1. Console Unpacked and Ready for Assembly

Assembly

To assemble the unpacked console, follow these steps in the indicated order.

Hook

1. Attach the gray hook to the front of the mast using the short bolt provided. Use a 7/64-inch Allen wrench to tighten the bolt securely (Figure 3.2).



Figure 3.2. Console With Hook Attached

Handle

2. Attach the handle to the mast using the long bolt and the short screw provided. Use a 3/16-inch Allen wrench to tighten the bolt securely. Use a 5/32-inch Allen wrench to tighten the screw (see Figure 3.3). Do not lift the console by the handle.



Figure 3.3. Use the Long Bolt and Center Screw to Attach the Handle

Display Head

3. Carefully remove the display head from its packaging.
4. Attach the display head to the mast. **Hold the pivot assembly perfectly vertical and slide it into the mast opening by applying even, gradual pressure.** The pivot assembly fits into the mast only in one direction.



Figure 3.4. Attach the Display Head to the Mast

5. Secure the display head to the mast by installing four screws in the holes provided at the top of the mast. Use a Phillips screwdriver to tighten the screws securely.

Control Cable

6. Connect the control cable to the socket on the lower right rear corner of the display head. Align the plug with the socket and gently push the plug into the socket until it is seated. Turn the retaining collar approximately two full turns clockwise to lock the plug in the socket.



Figure 3.5. Plug the Control Cable Into the Socket

Power Cord

7. Plug the female end of the power cord into the recessed power inlet connector. Wrap the power cord around the two cord hooks on the rear of the console.

Condensate Pan

8. Remove the condensate pan from its packaging and install it in the slot under the front of the console (refer to Figure 7.1).

Saline Container Insulating Jacket

9. Remove the saline container insulating jacket from its packaging and hang it on the saline container hook. Assembly is complete.

4. Operation

Overview

This chapter explains how to start treatment and change target temperature and rate settings during treatment. It provides instructions on the proper way to end treatment, including how to download patient temperature trend data to a laptop computer and how to remove used components and dispose of them safely.

Subsections at the end of this chapter provide detailed procedures for recovering from improper shutdowns, including special procedures for downloading patient temperature trend data.

This Overview section presents the main features of console.

After the Overview, you will find sections that describe in detail the operation of the console. The sequence of events that you must pass through in starting the console varies with the way it was last turned off. Within this section we will review the different patterns of interaction you will experience. Specifically we will review:

- Your first case with the console
- Variations in the Setup sequence of the console
- Ending procedures

Operating States

The console has three operating states: Setup, Standby and Run.

Setup

When the console is first powered up, it goes through a sequence of self tests. It tests its own electronics and internal sensors. These tests are called the POST (Power On Self Test). It is normal to hear two beeps during POST. Then the console tests its thermometer functions and its cooling engine. The extent of the testing during Setup and the interactions required of you by the console both vary depending upon the state of the console when it was last turned off.

You can pre-set the bath temperature so that the console is either cooling or warming the bath in Setup.

Patient temperature alarms are not active in Setup.

Console Self Tests

The console performs self tests both at initial power-on and then hourly during operation. These tests allow the console to check its own performance.

Thermometer Functions Self Test

The primary patient temperature monitoring circuit (T1) is checked during Setup and then hourly against the console's internal high resolution calibration resistor. This is a quick test.

Cooling Engine Self Test

During Setup and then every four hours, during Run, the console automatically tests its cooling engine. This test takes a few minutes.

Note. Cooling Engine Self Test - The pump stops. The cooling engine self test is brief. The console stops the pump during these tests to remove the heat load from the patient during the test. **The pump stops during this test. This is normal.**

During these tests, the roller pump is stopped (to remove the patient’s heat load from the equation). The tests that are conducted depend upon the state of the console at the time of the test. The test(s) done is (are) as follows:

Coolant Temperature	Heating Test	Cooling Test
<10 °C	✓	✗
10 °C - 38 °C	✓	✓
> 38 °C	✗	✓

✓ = will be performed ✗ = will not be performed

You will not see any screen messages unless there is an abnormal result in which case the appropriate alarm state will be called.

Sensor Checks

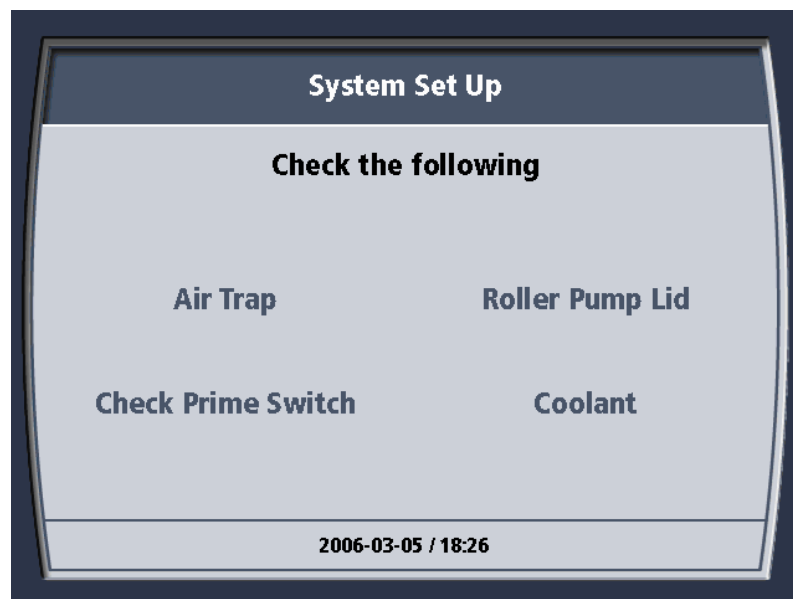

Figure 4.1. System Setup Screen

For the console to enter the next state, Standby, the following sensors must be checked and found normal.

Air Trap	There is no Start-Up Kit installed or there is a large amount of air in the Start-Up Kit chamber.
Roller Pump Lid	The clear plastic roller pump lid is not closed properly.
Check Prime Switch	The Prime Switch is being depressed (as when you use it to prime the console) or has been jammed in the On position.
Coolant	The coolant level is low. Top up the coolant well with coolant.

Table 4.1. Setup Sensor Checks

If any of these sensor states are not correct, you see the System Setup screen and the problem sensor state is highlighted in red (see Figure 4.1 above). Once you rectify the identified problems, the console progresses to Standby.

Note. Presence of patient temperature probes. The console can enter Standby without a T1 probe being connected; however, the console will not enter Run without the primary patient temperature probe (T1) connected to the console.

Standby

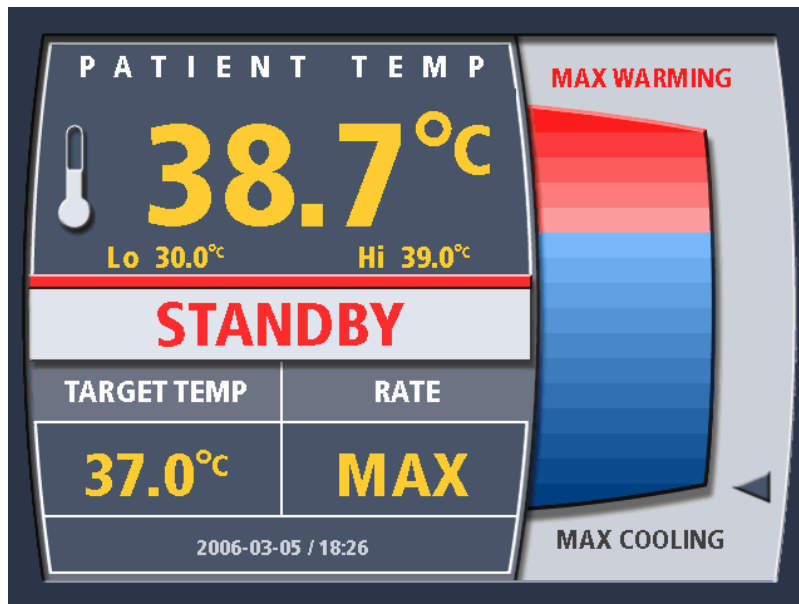

Figure 4.2. Operating Display - Standby

In Standby you can interact with the full user interface of the console. You can select the target temperature, the rate and the treatment mode.

Patient temperature alarms are active in Standby if the primary patient temperature probe (T1) is connected.

The coolant bath temperature graph is active in Standby.

From Standby you may toggle into and out of Run. You may only return to Setup by powering down the console.

Run - Treatment Modes

Once you are ready to begin treatment, you may move from Standby to Run. The console will become fully operational provided that all its sensors indicate that it is ready. Alerts will trigger if it is not.

There are three treatment modes in Run: Max Power, Controlled Rate, and Fever.

Max Power (MAX)

In this treatment option, the console aims to make the patient's temperature the same as the selected target temperature. The roller pump may stop temporarily when:

- The patient temperature is the same as the target temperature, or
- When you change the target temperature from cooling the patient to warming the patient, or vice versa. The roller pump automatically resumes operating to make the patient's temperature the same as target temperature.

Controlled Rate

In this treatment option, the console will attempt to move the patient's temperature to the target temperature at the programmed rate of heat exchange (°C/hr). When the patient reaches the target temperature, the console will revert to the MAX treatment option i.e. it will attempt to make the patient's temperature the same as the selected target temperature.

Note. Controlled Rate operates in both warming and cooling modes.

Fever (FVR)

In this treatment option, the console will start cooling the patient once the patient temperature is above the target temperature. It does this by keeping the bath at its coldest permissible temperature and then operating the roller pump whenever the patient's temperature moves above the target temperature.

WARNING. Lo patient temperature alarm limit with Fever. The console will not warm the patient when the Fever treatment option has been selected. The Lo patient temperature alarm limit ensures that an alarm occurs should the patient stop regulating his/her own body temperature. Such patients will cool to room temperature. This can occur when the patient dies or becomes comatose. **Investigate all patient temperature alarms.**

User Interface

The primary controls are mounted in the display head of the console. The next sections describe:

- Controls and display screen
- Menu system

Console Controls

The controls and display screen are illustrated in Figure 2.2 on page 15. The use of each control is described in the table below.

Power Indicator	Glows green when the display screen has power.
Alarm Indicator	Illuminates red during error conditions that prevent the console from displaying an alarm message.
Standby/Run button	Toggles between Run and Standby
Target Temperature button	Press this to change the target temperature
Rate Deg/Hr button	Press this to change the rate and/or treatment mode.
Press for Menu/Enter knob	This knob operates the menus on the display screen. Rotate the knob to scroll between selections. Press and release the knob to select.

Table 4.2. Console Controls

Display Screen

The console features a color display screen. Figure 4.3 shows the screen as it appears during Run.

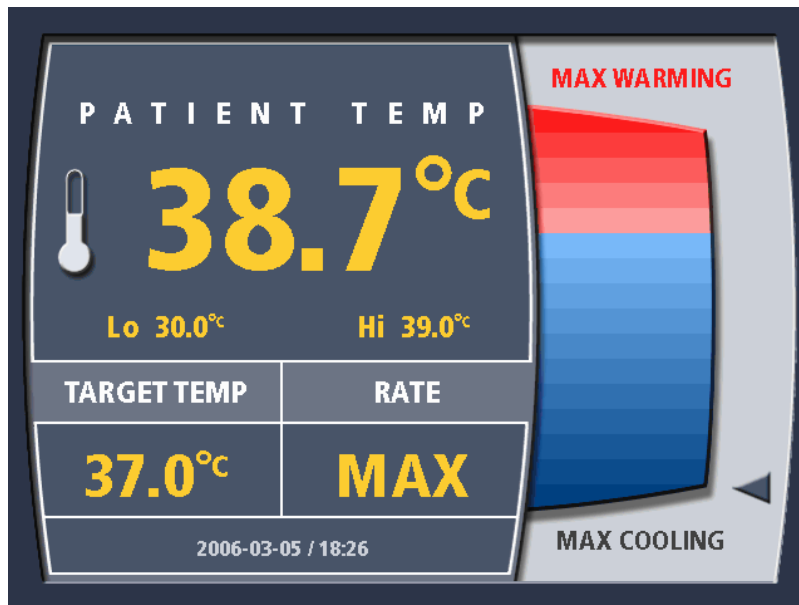

Figure 4.3. Operating Screen

The upper left hand of the screen displays:

- The patient temperature
- The Lo and Hi patient temperature alarm values.

The lower left hand of the screen displays:

- The programmed target temperature
- The programmed treatment mode/Controlled Rate value

The right hand side of the screen is used either:

- To display the temperature of the coolant in the console coolant well (as depicted above), or,
- To present menu selections. See Figure 4.4.

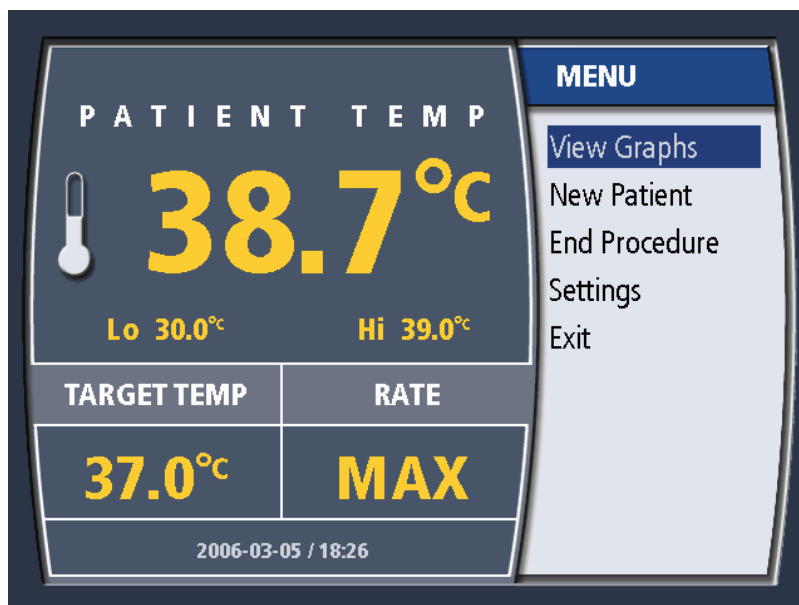

Figure 4.4. Main Menu

Changing Target Temperature

1. Press the Target Temp button once.
2. If you are in Run, you will be taken to Standby. The target temperature value may only be changed in Standby.

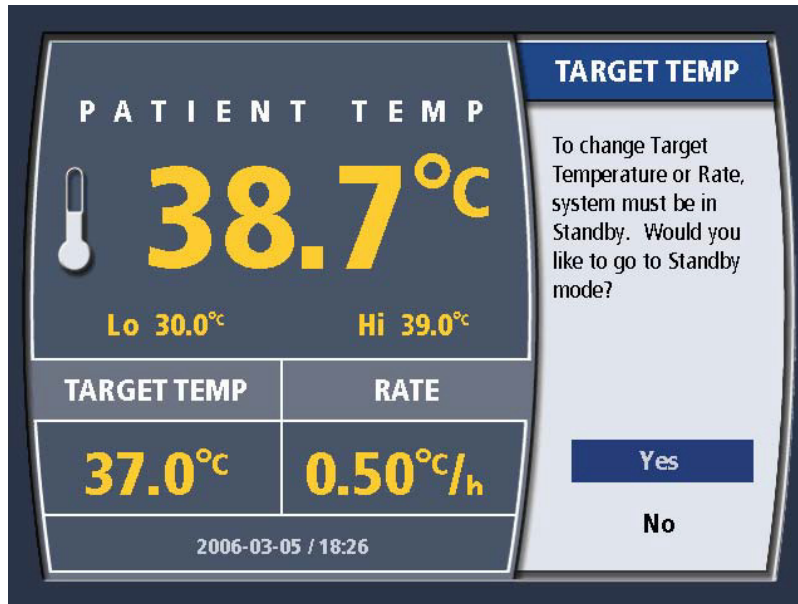

Figure 4.5. Change target temperature in Run

3. To change the target temperature, turn the knob until the desired temperature is displayed. You may choose a temperature from 31°C to 38°C (87.8°F to 100.4°F). When the correct selection is displayed, press the knob once to enter the selection.
4. The target temperature setting is updated on the display screen.

Changing Treatment Mode

As explained above, there are three treatment modes: MAX, Controlled Rate and Fever. To select the Treatment Mode, including one particular value of Controlled Rate you use the Rate Deg/Hr button.

1. Press the Rate Deg/Hr button once. If you are in Run, you will be taken to Standby. The Treatment Mode value may only be changed in Standby.

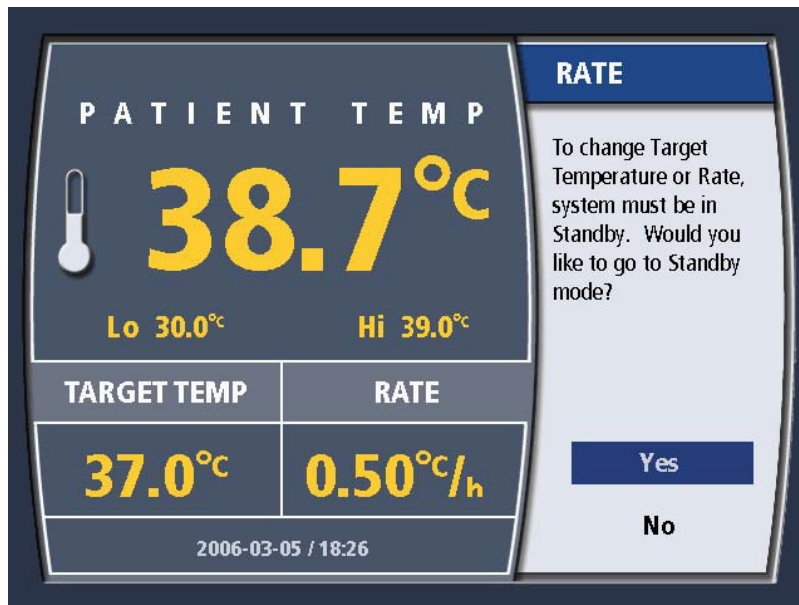

Figure 4.6. Change Rate/Temperature in Run

2. Turn the knob until the desired Treatment Mode selection is displayed. When the correct selection is displayed, press the knob once to enter the selection.

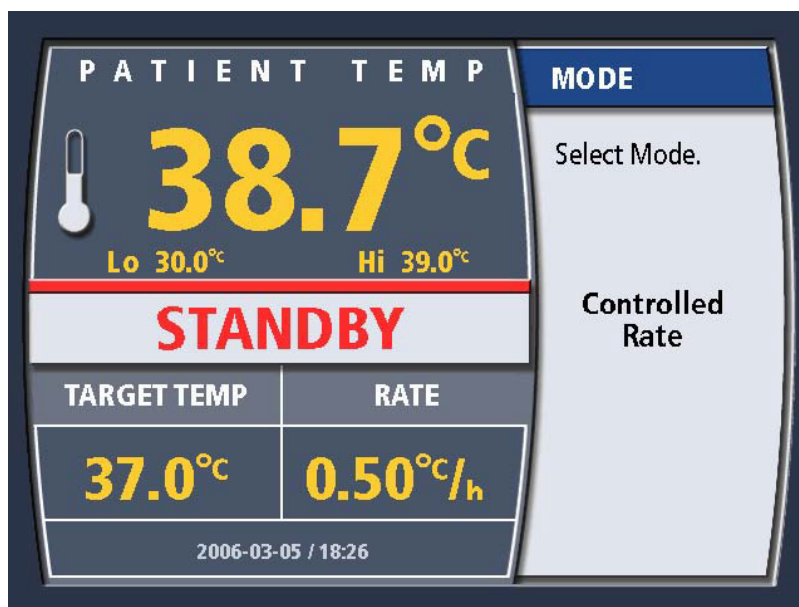

Figure 4.7. Select Mode

3. If you select Controlled Rate, a second menu screen will be presented. To change the rate, turn the knob until the desired selection is displayed. You may choose a rate from 0.10°C/hr to 0.65°C/hr. When the correct selection is displayed, press the knob once to enter the selection.

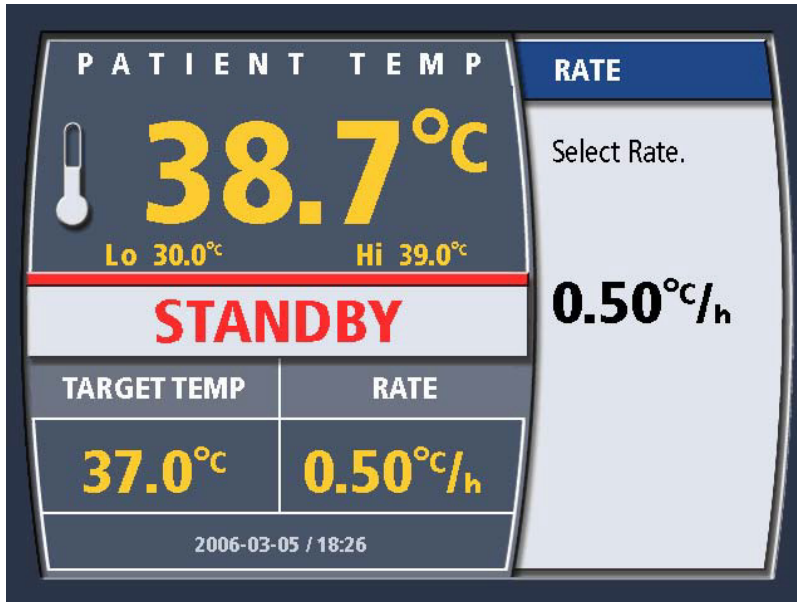

Figure 4.8. Select Controlled Rate

- If you have selected Fever mode, you will be asked to confirm your selection with the reminder that Fever mode only cools and does not warm per Figure 4.9.

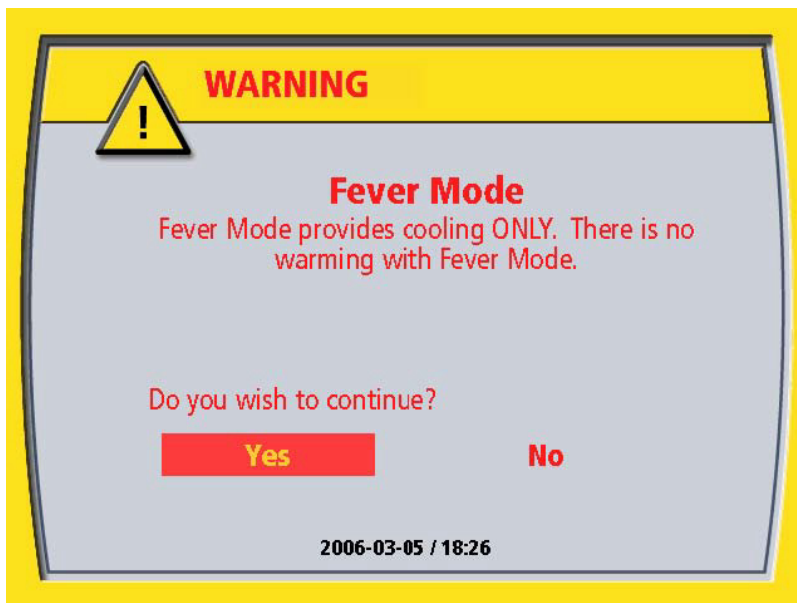

Figure 4.9. Fever Mode Confirmation message

- The display screen is updated to reflect your selection.

Note. Target temperature in Fever mode. The console keeps the bath cold and starts the roller pump when the patient temperature is greater than the target temperature.

Console Menus

Main Menu

The main menu is displayed in Figure 4.4. To access the main menu, press the knob from the operating display. Some settings are accessible only in Standby mode.

Available options are:

View Graphs	Takes you to a display of the patient temperature data log. See "Temperature Trend Data" on page 69.
New Patient	Indicates that you are starting a new patient case. Downloading or deleting the existing patient data log is required.
End procedure	Indicates that you are finishing a patient case. You will be prompted to save the existing patient data log. See "Ending Treatment" on page 65.
Settings	Takes you to the Settings menu. See below.
Exit menu	Closes the menu. The bath temperature meter display replaces the menu.

Table 4.3. Main Menu

Settings Menu

The Settings menu allows you to modify the information displayed on the operating display. It appears as in Figure 4.10.

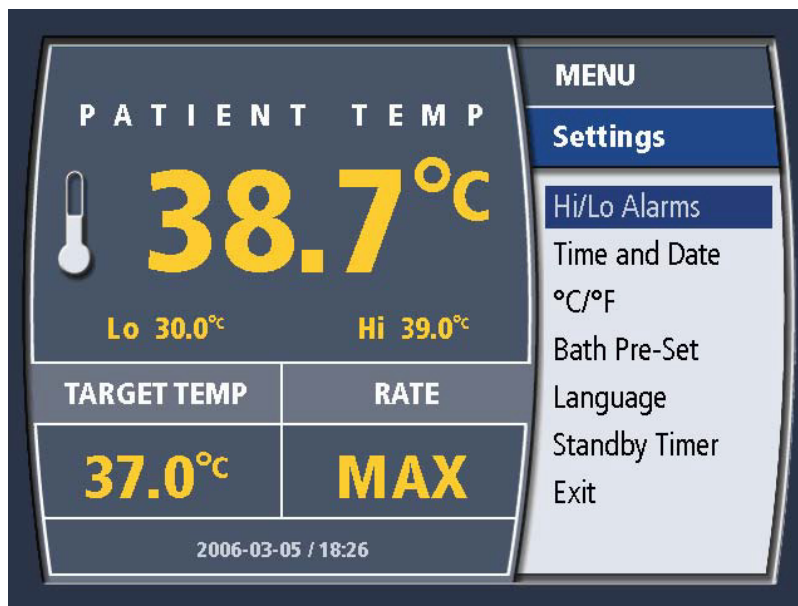

Figure 4.10. Settings Menu

The options offered by the settings menu are listed and described below.

Hi/Lo Alarms	Allows you to modify the low (Lo) and high (Hi) patient temperature alarms.
Time and Date	Allows you to modify the console time and date.
°C / °F	Allows you to toggle between displaying temperatures in degrees Celsius or degrees Fahrenheit.
Bath Pre-Set	Allows you to set the console to either Pre-Warm or Pre-Cool during Standby.
Language	Allows you to select the display language.
Standby Timer	Provides you with a warning alarm after the console has been in Standby for either 15 or 60 minutes. This alarm can be deactivated.
Exit	Closes the menu.

Table 4.4. Settings Menu

Hi/Lo Patient Temperature Alarms

The console features two patient temperature alarms: Hi and Lo. If the alarms are set, the console triggers an alarm whenever the patient's temperature is higher than the Hi patient temperature alarm value and whenever the patient's temperature is lower than the Lo patient temperature alarm value. The range of values for the Hi and Lo alarms is 28°C – 45°C (82.4°F – 113.0°F).

Setting the Alarms

The alarm values are set in either Standby or Run mode. To set the patient temperature alarms:

1. Press the knob. The Main Menu appears.
2. Select Settings and press the knob.
3. Select Hi/Lo Alarms.
4. From the Hi/Lo Alarms menu:
 - To set the Lo alarm value:
 - a. Select Lo Alarm. The Lo alarm value appears.
 - b. Turn the knob until the desired value is displayed and press the knob.
 - To set the Hi alarm value:
 - a. Select Hi Alarm. The Hi alarm value appears.
 - b. Turn the knob until the desired value is displayed and press the knob.

Nature of the Alarm

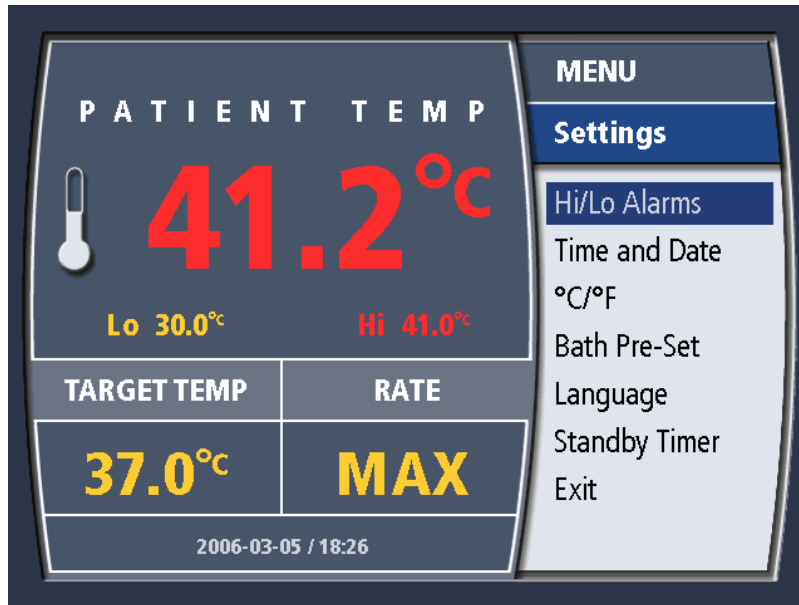

Figure 4.11. Hi Patient Temperature Alarm

The alarms are both visual and audible. The alarms will not clear until the patient's temperature no longer triggers the alarm state.

The audible alarm may be temporarily muted for 2 minutes by pressing the Mute button. The alarm will continue after that time unless it has cleared.

The visual alarm displays the patient temperature in flashing red text. The visual alarm will not stop until the alarm has cleared.

WARNING. Setting of patient temperature alarms. The patient temperature alarms are programmable. They cannot be deactivated. Press the Mute button to mute the alarm for 2 minutes.

Note. Patient temperature alarms in Standby. If the console is in Standby and the T1 temperature probe is connected to the console but not inserted into the patient, a Lo patient temperature alarm can be triggered if the ambient temperature of the exposed probe is below the alarm limit. To avoid the alarm under these conditions, unplug the T1 temperature probe from the console until you are ready to connect to the patient. You may not enter Run without the probe connected to the console.

Bath Pre-set

The menu allows you to select from either: Pre-Cool, Pre-Warm or None. This selection operates only in Standby and is canceled when the console enters Run.

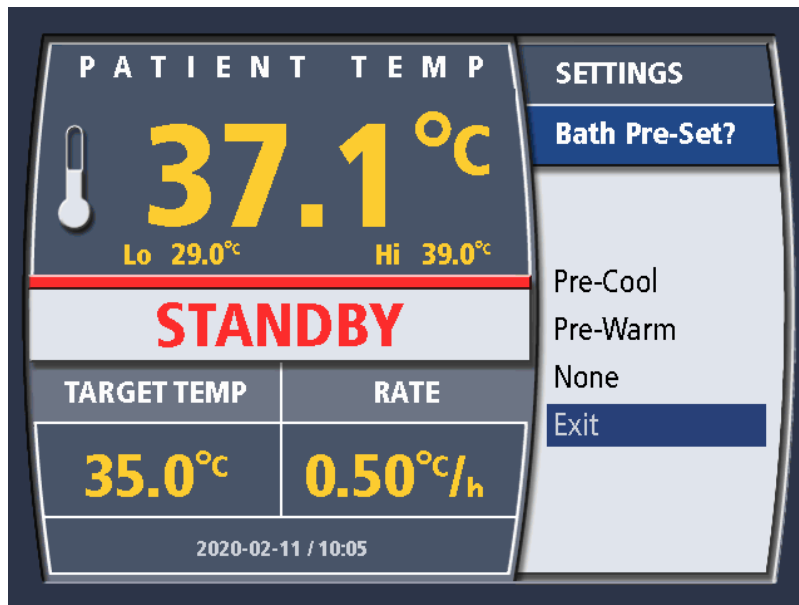

Figure 4.12. Bath Pre-Set Menu

Pre-Cool	The console bath is cooled to its lowest permitted temperature and maintained at that temperature.
Pre-Warm	The console bath is heated to its highest possible temperature and maintained at that temperature.
None	The Bath Pre-set is not activated or is canceled. If canceled, the bath is maintained at the temperature that was measured at the time of cancellation.
Exit	Closes the menu without a change in console status or programming.

Time and Date

This menu displays the current time and date settings.

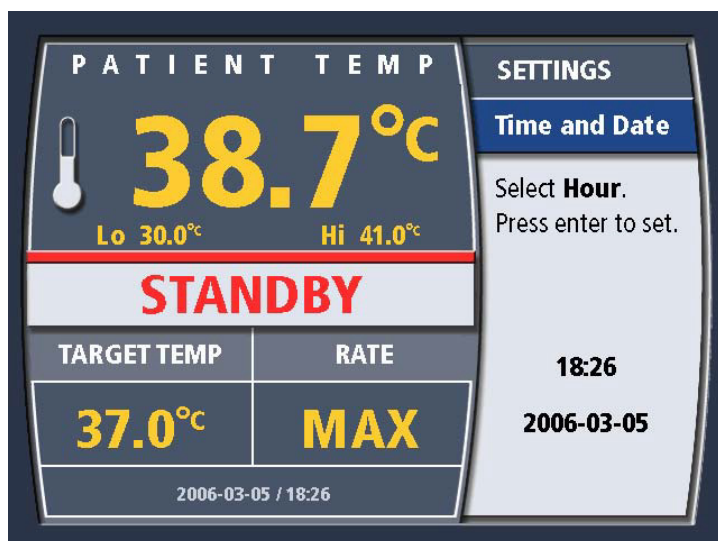

Figure 4.13. Time and Date Settings

The time is divided into two fields: hours (designated "HH") and minutes ("MM"). The console uses only 24-hour time notation (e.g., 3:00 p.m. is 15:00).

The date is divided into three fields: year (designated "YYYY") - month (designated "MM") - day (designated "DD"). For example, the 24th February, 1959 would be shown as: 1959-02-24.

Time Setting

1. The screen first displays the message "Select Hour. Press Enter to set."
2. The numbers displayed in the hour field will change as you turn the knob. When the correct hour is displayed, press the knob once to enter your selection.
3. The screen next displays the message "Select Minute. Press Enter to set."
4. Turn the knob until the correct minute is displayed. Press the knob once to enter your selection.

Date Setting

1. The screen displays the message "Select Day. Press Enter to set."
2. The numbers displayed in the day field will change as you turn the knob. When the correct day is displayed in the field, press the knob once to enter your selection.
3. The screen next displays the message "Select Month. Press Enter to set."
4. Turn the knob until the correct month is displayed. Press the knob once to enter your selection.
5. The screen next displays the message "Select Year. Press Enter to set."
6. Turn the knob until the correct year is displayed. Press the knob once to enter your selection.
7. The time and date settings will be updated and the screen will display the settings menu.

°C/°F (Temperature Notation)

This menu displays the options setting for temperature notation. The currently selected setting is highlighted.

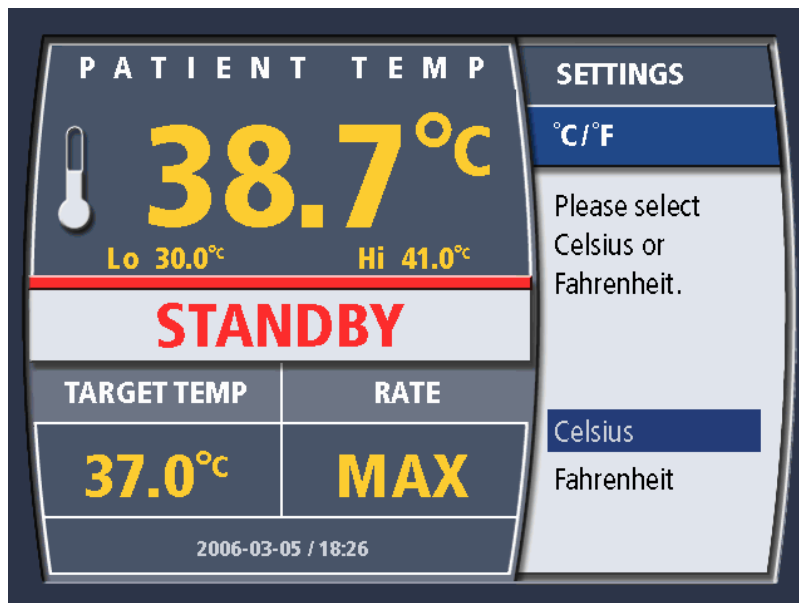

Figure 4.14. Temperature Notation Settings

To keep the current selection, press the knob once. The current setting will not be changed and the settings menu will be displayed.

To change the current setting, turn the knob to highlight the desired setting. Press the knob once to enter the selection. The setting will be changed and the settings menu will be displayed.

Language

This menu displays the current setting for the language used for displayed text. The currently selected setting is highlighted.

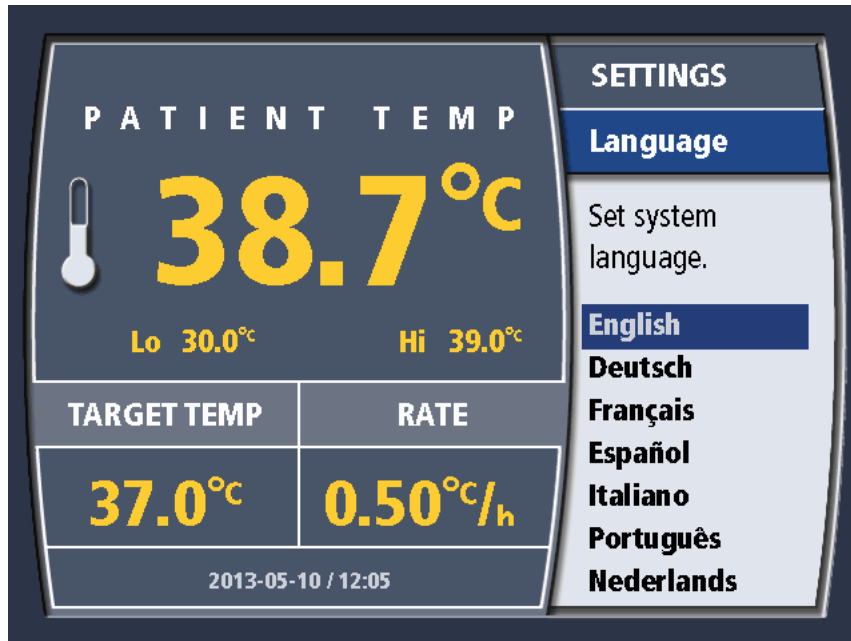

Figure 4.15. Language Settings

To keep the current selection, press the knob once. The current setting will not be changed and the settings menu will be displayed.

To change the current setting, turn the knob to highlight the desired setting. Press the knob once to enter the selection. The setting will be changed and the settings menu will be displayed.

Standby Timer

The Standby Timer provides an alarm as a reminder when the console has been left in Standby for 15 or 60 minutes. The Standby Timer's selections are: No Alarm, 15 minutes, 60 minutes.

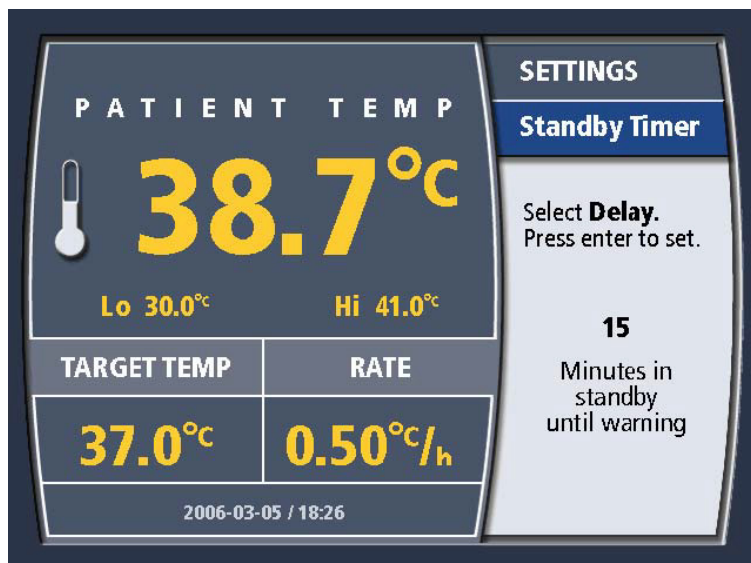

Figure 4.16. Standby Timer Menu

If the console has been left in Standby for more than the specified time, an alarm will sound to remind that the console remains in Standby. Pressing the knob will reset the timer. The Standby Timer function will continue until either:

- The console is placed into Run.
- The Standby Timer Menu is used to deactivate the Standby Timer.

The Standby Timer alert may be silenced for two (2) minutes by pressing the mute button.

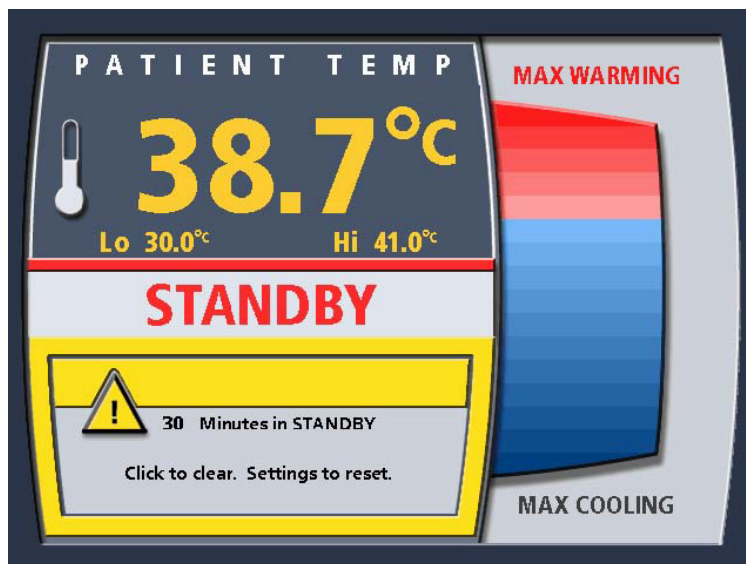

Figure 4.17. Standby Timer Alert

T1/T2 Behavior

WARNING. Dislodged Foley Catheter Temperature Probe. The console can detect when a patient temperature probe is dislodged suddenly from the patient. However, it is possible for the Foley catheter patient temperature probe (T1) to become dislodged from the bladder to rest on the perineum or within the fold of the thighs. In

this position, the console may not detect the dislodgement from the patient and will underestimate the patient's core temperature. As a result, the console may inappropriately warm the patient. Failure to use a second temperature probe may result in patient injury.

First Use Warning – No T2 Probe

For each time the console is powered on:

1. The console will check to see if the Primary (T1) and Secondary (T2) Temperature Probes are present. The console will enter Standby without probes being present. The console will not enter Run unless the T1 probe is present.
2. When the console is first put into Run, it will check to see which probes are present.
3. If there is no T2 present, the console will ask you to verify that this is intentional. See image below.

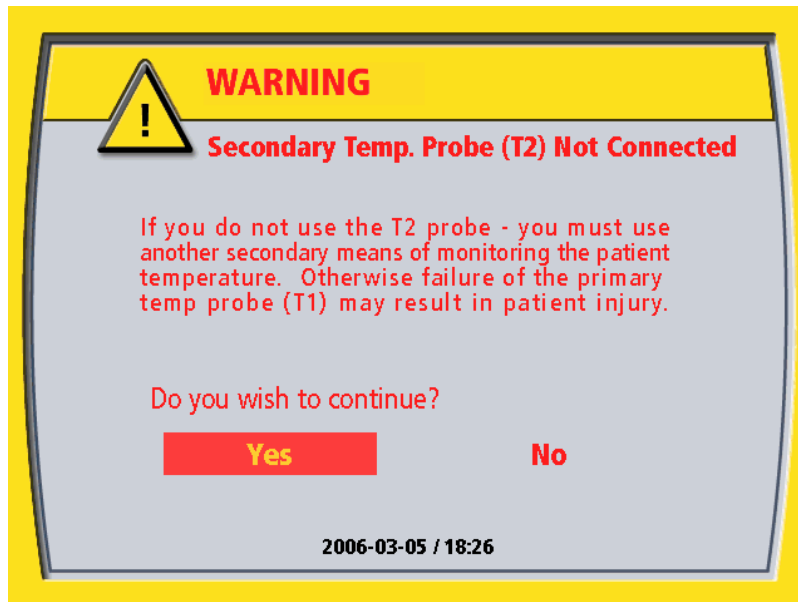

Figure 4.18. No T2 Probe Connected
The console remembers the User's preference.

T2 Probe Disconnection/Reconnection

If you connect a T2 probe at any time during console operation (in Standby or Run), the console will assume that use of the T2 probe is desired. If the T2 probe is disconnected, the console triggers an alarm – see below.

If you disconnect a T2 Probe in Standby, the console will not assume that this is intentional. When the console is placed into Run without a T2 Probe present, you will see the Warning as described above again.

Accidental Disconnection T1/T2 Probe

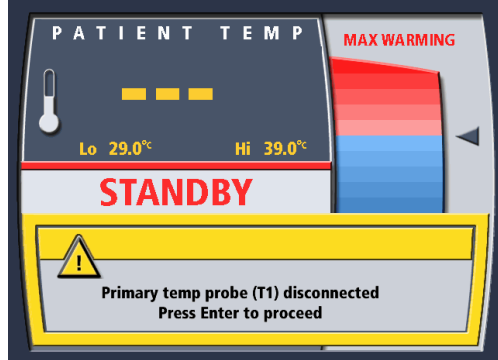
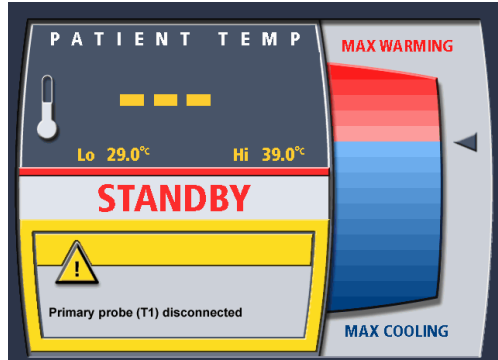
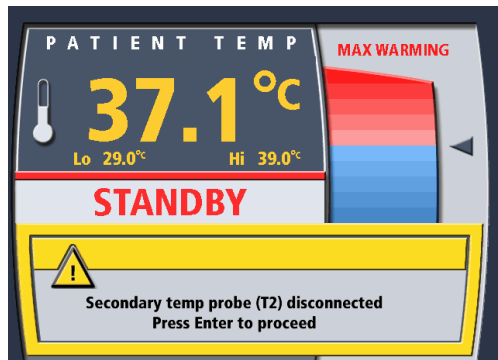
<p>Disconnection of the T1 probe during Run results in an alarm. The console moves to Standby. Press the knob to silence the alarm. Treatment cannot continue until the T1 probe has been replaced.</p> <p>Note that the patient temperature is displayed as “—” and the yellow warning banner covers the bath temperature display.</p>	
<p>Absence or disconnection of the T1 probe during Standby results in a warning display without a persistent audible alarm. The console cannot enter Run until a T1 probe has been connected.</p> <p>Note that the patient temperature is displayed as “—” and the yellow warning banner does not cover the bath temperature display.</p>	
<p>Disconnection of the T2 probe during Run results in an alarm. The console moves to Standby. Press the knob to silence the alarm. If you attempt to return to Run without reconnecting the T2 probe, you will be asked to verify your intention.</p> <p>Note that the patient temperature will be displayed correctly if the T1 probe remains connected. The yellow warning banner covers the bath temperature display.</p>	

Alarms & Alerts

A detailed description of the alarms of the console is provided in later sections of this manual. See:

- Alarms and Corrective Actions on page 85
- Troubleshooting on page 89

Alerts

Alerts can be cleared by correcting the problem that caused them to occur. For example, a low coolant alert can be cleared by adding coolant to the coolant well of the console. In most cases, the console will identify and notify you to rectify alert states at power up.

In Standby, alerts are displayed across the lower half of the display screen, with the bath temperature display not obscured, against a yellow background (See Figure 4.19 – Right). Alerts in Standby are generally not accompanied by an audible alarm tone.

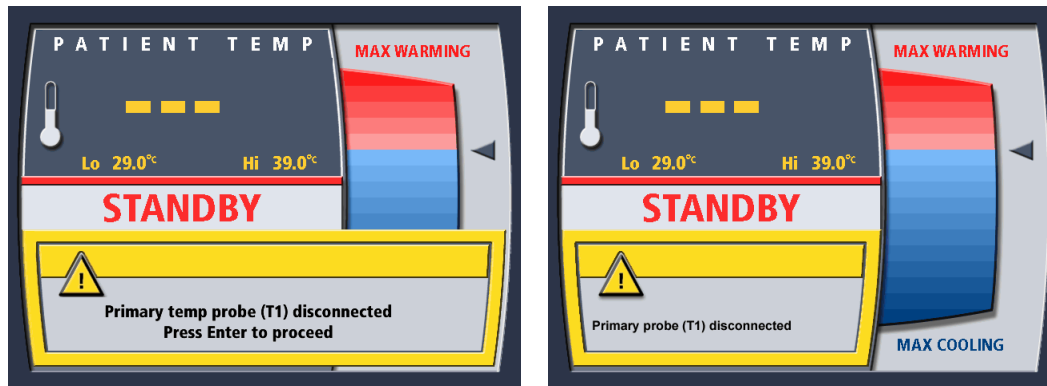

Figure 4.19. Disconnect alarm from Run (left) and alert from Standby (right)

In Run, alarms are displayed across the full lower half of the display screen against a yellow background with the bath temperature display is partially obscured (See Figure 4.19 – Left). If an alarm occurs in Run, the console will generally revert to Standby and an audible alarm tone will sound. The exception to this is that if you depress the prime switch during Run – no audible alarm will sound and the bath temperature display will not be obscured.

In both Standby and Run, a message on the screen will indicate the action required to clear the alarm or alert.

During an alert, the patient temperature display is still visible and the patient temperature alarms are still active if the T1 Temperature probe is functional.

Note. In the event of an alert: Investigate and rectify the cause - refer to: Alarms and Corrective Actions on page 85 and Troubleshooting on page 89. If the alert persists, call ZOLL for service.

Alarms

An alarm is more serious in nature than an alert and relates to issues that will typically require a service call. In most cases a text message, specific to the alarm, identifies the code for the alarm. For example, the screen might announce "TCM ID 01" or "MID 23" in addition to the text in Figure 4.20.

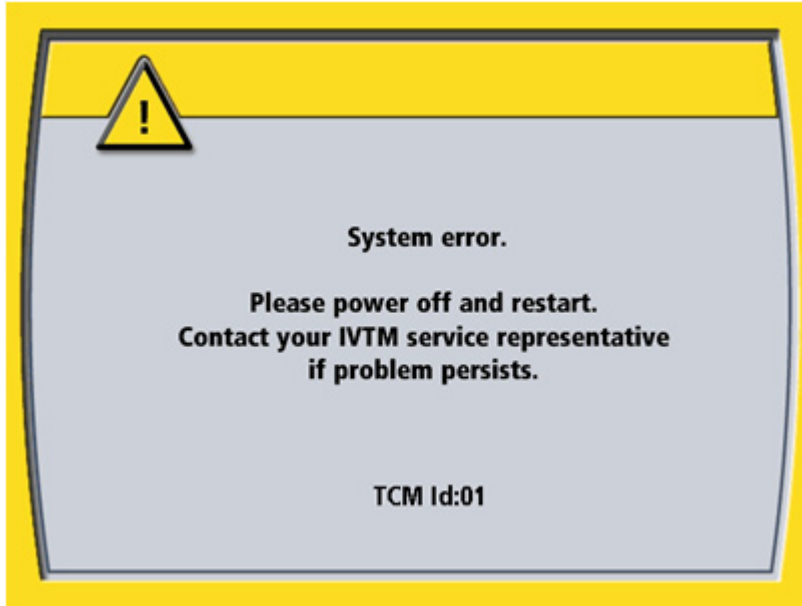

Figure 4.20. Alarm Screen

In some cases, however, the alarm may be cleared by power cycling the console. For example, such an alarm would occur if the pump tubing were to become jammed in the roller pump causing the pump to slow down.

If the reason for the alarm is not cleared by power cycling, the alarm will repeat each time the console is turned back on.

During an alarm, the patient temperature display and the patient temperature alarms are not active.

Note. In the event of an alarm: Investigate and troubleshoot the cause - refer to: Alarms and Corrective Actions on page 85 and Troubleshooting on page 89. If the alarm persists, call ZOLL for service.

Your First Case

What you need

You will need the following for each case:

- A new Start-Up Kit
- A new 500ml bag of normal saline.
- A YSI-400 compatible temperature probe e.g. a Foley catheter, rectal or esophageal temperature probe
- The blue patient connection cable to connect the temperature probe to the console
- A ZOLL heat exchange catheter
- An aseptic work area to support catheter insertion.

WARNING. Refer to catheter IFU. ZOLL heat exchange catheters are inserted via a Seldinger technique similar to a central venous line. There are specific instructions for use included with each catheter. Refer to these to understand the specific unique insertion requirements of a ZOLL heat exchange catheter.

Preparing the Console for Treatment

To prepare the console for treatment, follow these steps in the indicated order.

1. Roll the console to a convenient position near the patient's bedside. Plug the power cord into a hospital-grade receptacle.
Caution. The console left and right side panels contain vents for air flow. Ensure the vents are not covered during operation.
2. Lock the right front caster by stepping down on the tab above the wheel.
3. At the rear of the console, near the upper left corner is the power on/off switch. Turn the switch ON.



Figure 4.21. Power Switch and Power Indicator Lamp

4. The green power indicator lamp will be illuminated and the alarm will beep one long beep followed by a shorter softer beep.
5. The console performs a self-test. During this interval, the self-test screen appears on the display screen. If the self-test detects a problem, an error message will be displayed. If this occurs, refer to Alarms and Corrective Actions on page 85 for assistance. At the end of the self-test there will be two short beeps.
Note. The software version shown in Figure 4.22 is shown for reference only; the current product may use a different software version.



Figure 4.22. Self-Test Screen

- When the self-test is finished, the System Set Up screen displays the message "Bath Pre-Set?"

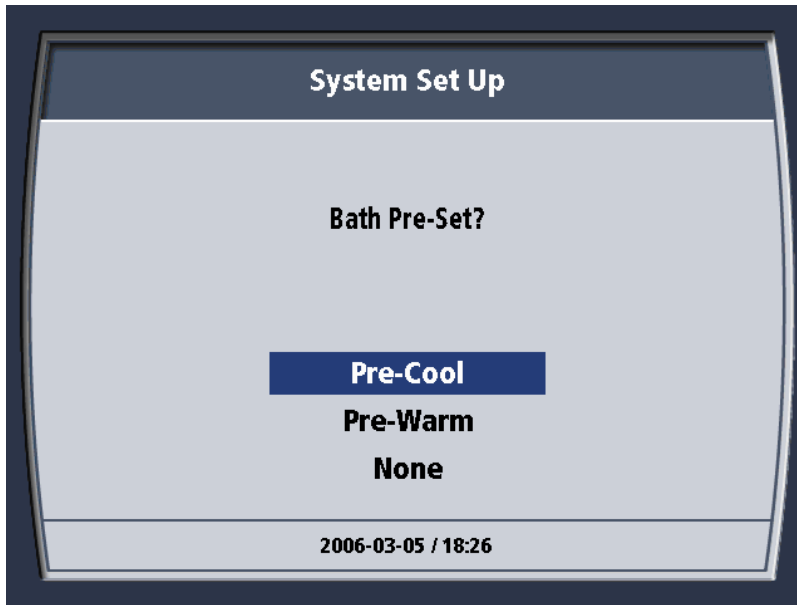

Figure 4.23. Bath Pre-Set?

- To start cooling or warming the coolant well immediately, choose the desired option and press the "Press for Menu/Enter" knob (the "knob") once to enter the selection. If you do not wish to begin cooling or warming the coolant well now, choose "None" and press the knob once to enter the selection.
- You may be asked questions relating to the downloading of patient data. This is a new patient. Delete any old data left from the inservice you received.

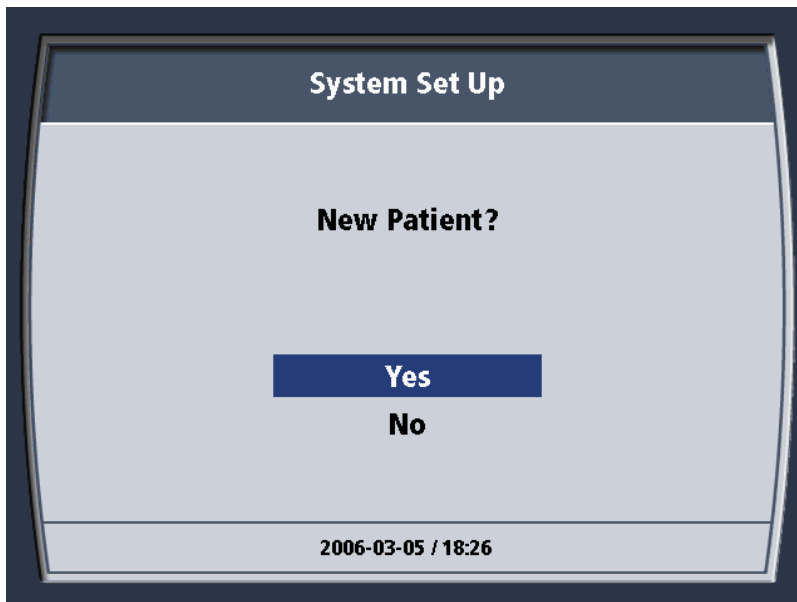

Figure 4.24. New Patient? Message

- Choose Yes.
- The screen displays the message "Previous patient data must be downloaded or deleted to proceed."

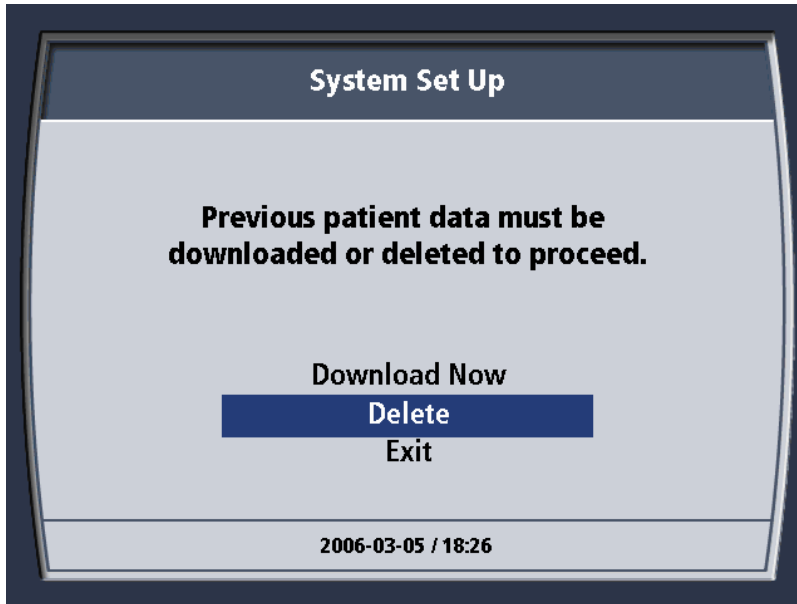

Figure 4.25. Patient Data Message.

11. Choose Delete. You will be asked to confirm your choice to delete the data file. Choose Yes. A brief confirmation message will appear and then automatically close. See below.

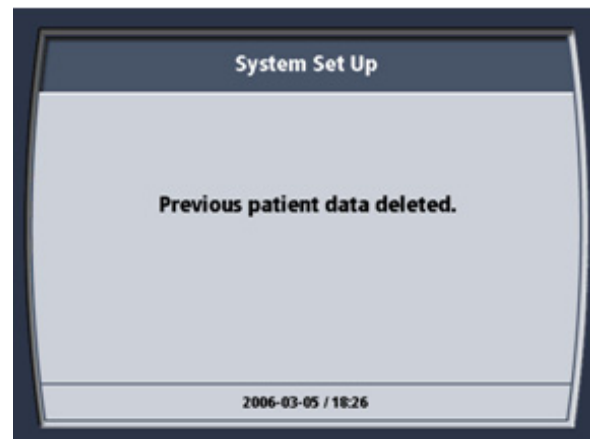
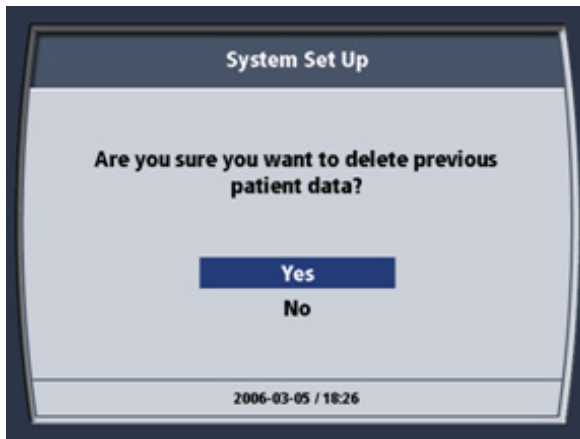

Figure 4.26. Delete Previous Patient Data

12. The System Set Up screen then displays the message "Select Target Temp."

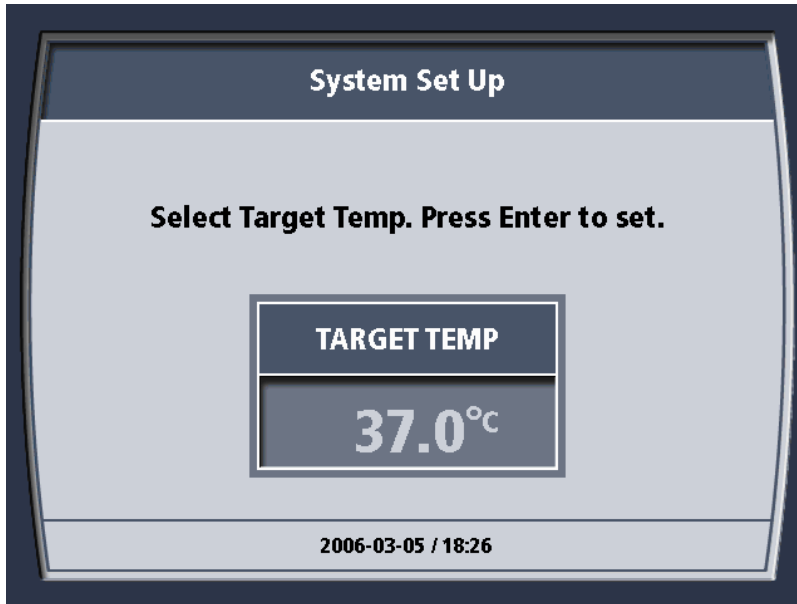

Figure 4.27. Select Target Temp Message

13. Turn the knob until the target patient temperature is displayed. When the desired value is displayed, press the knob once to enter the selection.
14. The System Set Up screen displays the message "Select Treatment Mode". Note that you have three choices: Max Power, Controlled Rate or Fever.

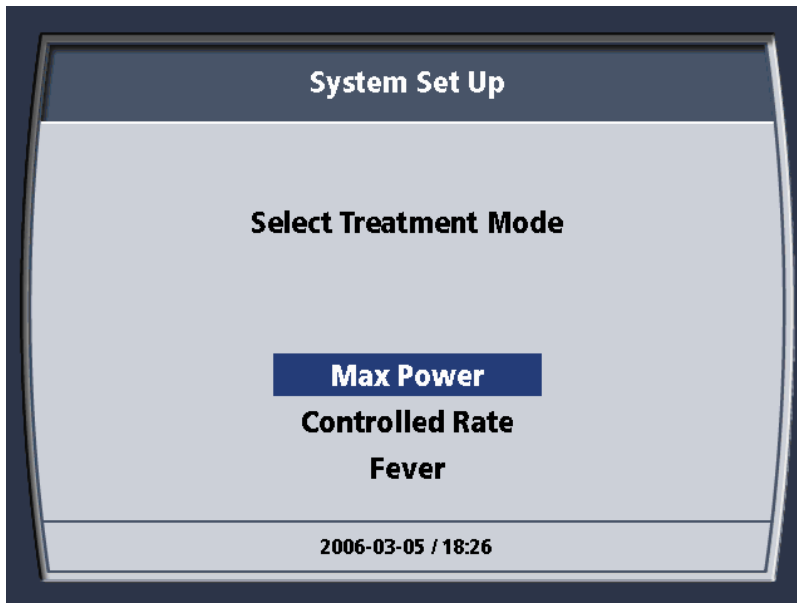

Figure 4.28. Select Treatment Mode Message

15. Turn the knob to highlight the desired mode. Press the knob once to enter the selection. Controlled Rate should not be selected when using the Cool Line catheter.
16. If you select Controlled Rate for the Treatment Mode, you will be prompted to "Select Rate. Press Enter to Set". Use the knob to scroll through to the desired rate and then press the knob to select it.



Figure 4.29. Select Rate Screen

17. If the console has not yet finished its self tests, the Self-Test screen is displayed.

Note. The Software Version shown in Figure 4.31 is for reference only; the current product may use a different Software Version.



Figure 4.30. Self-Test Screen

18. Install the Start-Up Kit now. If the console finishes its self test before you complete installing the Start-Up Kit, you will see the following Check Screen. An item in red requires your attention.

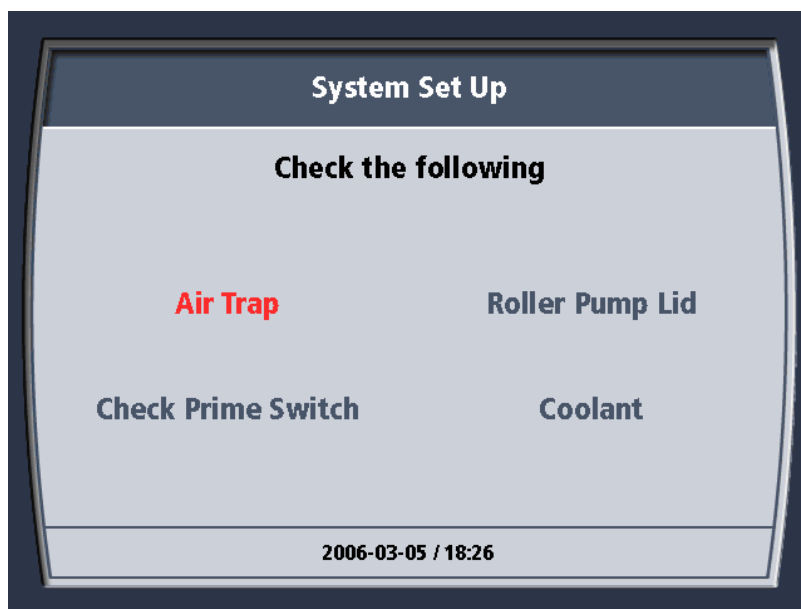

Figure 4.31. Check the Following Screen

Air Trap	There is no Start-Up Kit installed or there is a large amount of air in the air trap chamber.
Roller Pump Lid	The clear plastic roller pump lid is not closed properly.
Check Prime Switch	The Prime Switch is being depressed (as when you use it to prime the console) or has been jammed in the On position.
Coolant	The coolant level is low. Top up the coolant well with coolant.

Table 4.5. Setup Sensor Checks

Installing the Start-Up Kit

Hang the Saline Bag

To install the Start-Up Kit, follow these steps in the indicated order.

1. Obtain an IV bag or bottle of sterile normal saline solution. The bag or bottle must contain no more than 0.5 liter (500 ml) of solution. Hang the saline container on the hook mounted on the rear of the display head. The container hangs inside the circumference of the handle.



Figure 4.32. 500ml Saline Bag on Hook

The Top Cover

2. Open the top cover of the console. Open the transparent top cover of the roller pump.



Figure 4.33. Covers Open

3. A tubing circuit diagram is printed on the inside of the console top cover. Refer to this diagram when installing the Start-Up Kit. See Figure 2.8 on page 20.

Coolant well

4. Remove the cap from the coolant well and set it aside in a clean location.



Figure 4.34. Coolant Well Cap

5. Check the level of the coolant. The liquid level should be between the two indicator lines on the wall of the coolant well. If the level is below the bottom indicator line, fill the coolant well with coolant (a ZOLL-approved 50% propylene glycol / 50% deionized water mixture) until the liquid level reaches the MAX line. Add coolant in an area where spills can be managed appropriately.



Figure 4.35. Coolant Well Liquid Level Indicator Lines

The Start-Up Kit

6. Open the Start-Up Kit. For convenience and sterility, all items in the kit are pre-connected.

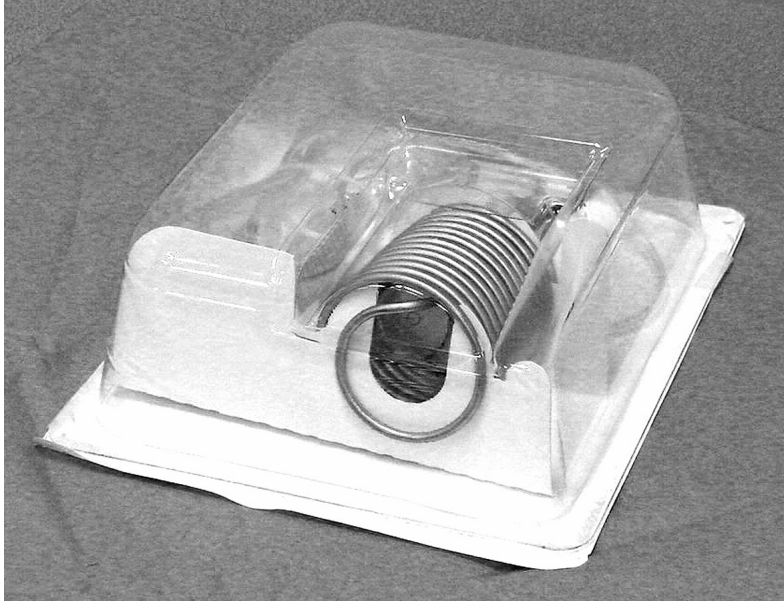

Figure 4.36. Start-Up Kit

7. Insert the heat exchange coil into the coolant well.



Figure 4.37. Installing the Heat Exchange Coil

8. Temporarily slide the air trap into the coolant well.

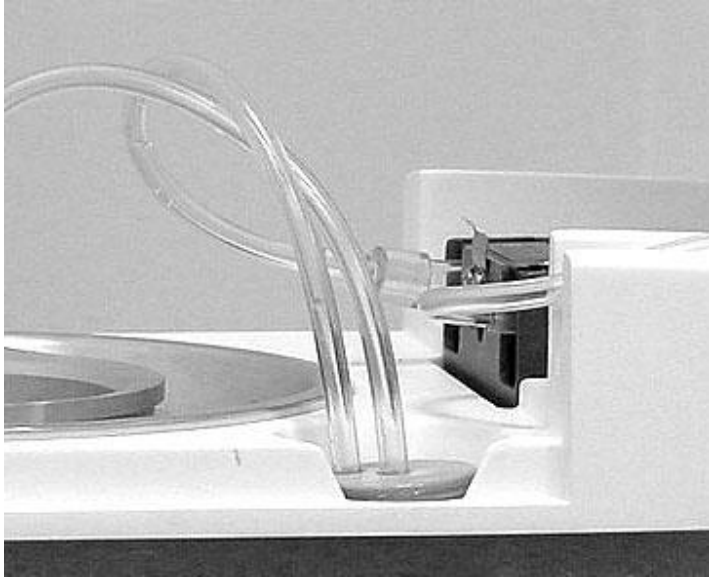

Figure 4.38. Air Trap Placed In Chamber

Roller Pump



WARNING. Finger injuries. Be careful when inserting the roller pump tubing that you do not catch your fingers with the roller. When the console is operating, do not attempt to circumvent the safety interlocks on the roller pump lid. Do not place fingers or foreign objects into the pump raceway when the pump is turning. The roller pump has sufficient torque to severely damage a finger.

9. Locate the pump tubing. Do not stretch or pull on the tubing. The tubing lengths and flanged connector allow the tubing to fit into the pump in only one direction.
10. Lift the handle on the pump rollers.



Figure 4.39. Lift the Pump Rollers Handle

11. Place the flanged connector of the pump tubing into the slot on the right side of the pump head.

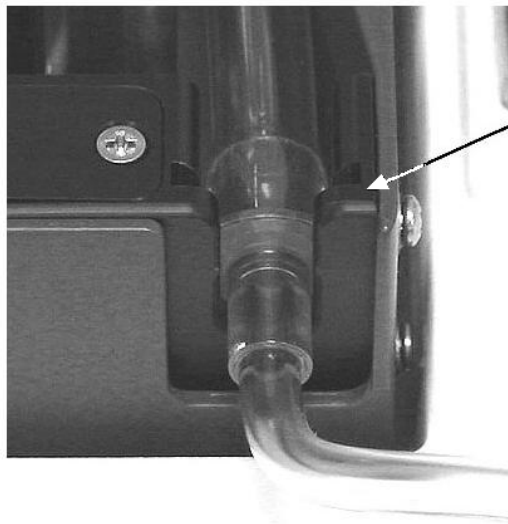

Place flanged connector into socket on right hand side of pump raceway.

Figure 4.40. Flanged Connector Fits Into Recess

12. Load the pump tubing around the rollers and into the channel of the pump head. You must turn the handle counterclockwise as you feed the tubing into the channel. Press down firmly on the tubing until it settles into the bottom of the channel. Once the tubing is installed, press the handle down onto the rollers until it presses into its detent.



Figure 4.41. Pump Tubing Installation

13. Close the top cover on the pump. It will snap shut.

Cover the coolant well

14. Replace the cap on the coolant well. Position the cap so that the heat exchange coil and tubing fits into the notch. Press down on the cap to create a tight seal.



Figure 4.42. Replace the Cap on the Coolant Well

Spike the Saline Bag

15. Using aseptic technique, connect the priming line to the sterile saline container. The priming line is equipped with a spike connector. Hang the saline container on the hook provided.



Figure 4.43. Making a Sterile Connection to the Saline Container

Caution. Start-Up Kit spike. The spike on the Start-Up Kit is relatively long. Be careful not to puncture the side wall of the saline bag when connecting to the Start-Up Kit.

Prime & Fill the Air Trap

16. Remove the air trap from its chamber and hold it upside down (with the tubing connections pointing downward).



Figure 4.44. Hold the Air Trap Upside Down

17. Prime the air trap and the tubing circuit by pressing and holding the Prime switch. The roller pump will slowly start and take about 20 seconds to come up to operating speed. Observe the movement of saline until it fills the air trap and the entire length of the tubing. The Prime switch will only function after the console self-tests is completed.



Figure 4.45. Use the Prime Switch to Prime the Tubing Circuit

18. Continue to hold down the Prime switch. When the air trap is completely filled with saline, tap it to dislodge any remaining air bubbles. Observe the 500 ml saline bag. When bubbles are no longer seen in the saline bag, priming is complete. Release the Prime switch.

Note. Air trap. The air trap must be completely filled for proper console operation.

19. Turn the air trap right side up and insert it in the chamber.
20. Place the tubing to the catheter in the two notches at the front of the console. Place the priming line and the saline return line in the channels leading to the rear of the console. Close the top cover of the console.

Caution. Damage to top cover. Do not sit on the top cover or place heavy objects on the top cover.



Figure 4.46. Route the Tubing Out of the Console

21. Lift the saline container off the hook and slip the insulating jacket around the container. Carefully close the hook-and-loop fasteners at the top and bottom of the jacket. Rehang the container on the hook.
22. When the self tests are completed and the Start-Up Kit is loaded and primed, the console will enter Standby. The console is ready to be connected to the patient.

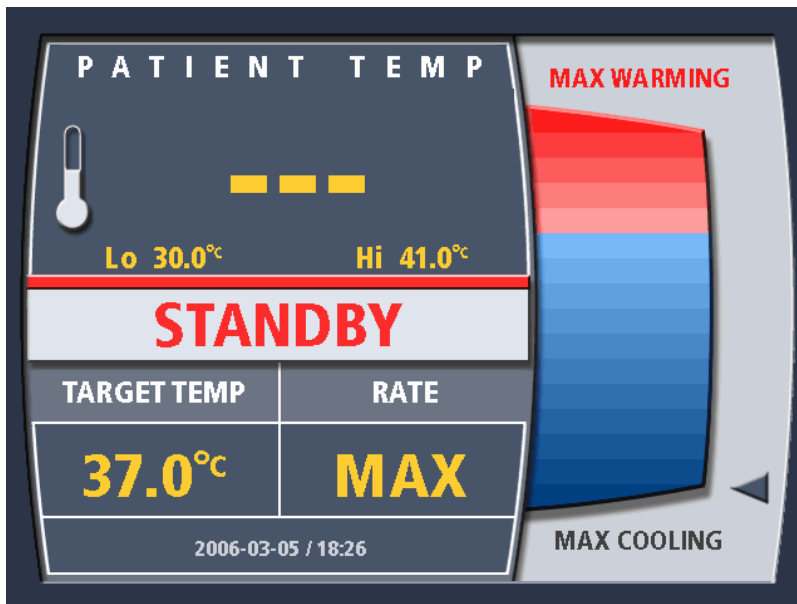

Figure 4.47. Standby Screen – T1 Probe Not Connected

Connecting the Patient to the Console

WARNING. Verify console function first. Ensure proper functioning of the console and initiate pre-cool or pre-warm (if applicable) prior to placing the catheter in the patient.

When the console has been prepared as directed in the preceding sections, it may be moved to the patient's bedside and connected to the patient. Follow these steps in the indicated order.

1. Position the console near the patient's bed. It must be close enough so that the temperature probe cables and the tubing can conveniently reach the patient. Route the cables and tubing safely.

2. If the primary and secondary patient temperature probes have not been placed in the patient, this should be done now. Refer to the Instructions for Use that accompany the temperature probes for information about the probes.
3. Connect the blue patient temperature cable to the YSI-400 primary temperature probe (e.g. Foley catheter, rectal or esophageal). Connect the plug at the end of the blue patient temperature cable into the connector labeled "T1" on the front of the console.



Figure 4.48. Temperature Probe Connections

4. If you are using a secondary patient temperature probe, connect the blue patient temperature cable to the YSI-400 secondary temperature probe. Connect the plug at the end of the blue patient temperature cable into the connector labeled "T2" on the front of the console. If you are not using a secondary temperature probe, the patient **MUST** be monitored by a separate hospital patient temperature monitor.
5. Place the ZOLL catheter in the patient now. Refer to the Instructions for Use for information about the catheter.
6. The tubing to the catheter is supplied with the supply and return connectors connected to each other. Using aseptic technique, disconnect the two connectors.

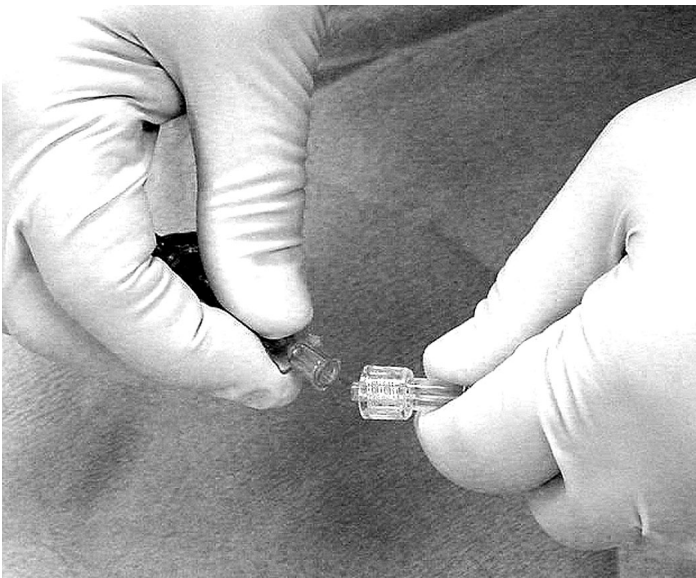

Figure 4.49. Disconnect the Connectors Using Aseptic Technique

7. Connect the female tubing connector to the male connector on the catheter. The gender of the tubing connectors and the catheter connectors ensures that they cannot be connected backwards.

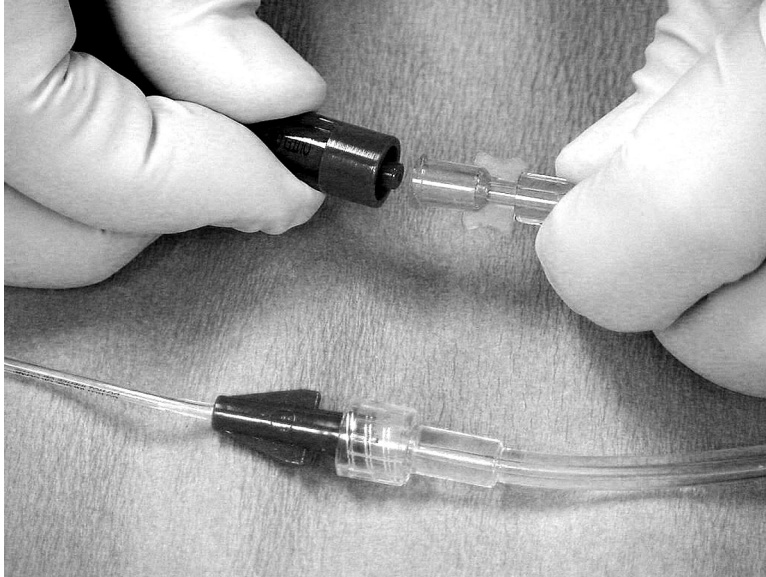

Figure 4.50. Connect the Tubing to the Catheter

8. Connect the male tubing connector to the female connector on the catheter. Note that the return line is equipped with an inline flow-indicator.
9. Safely route the tubing so that it is not kinked or obstructed and cannot be easily dislodged by a patient's movement.

The console is now ready to begin treatment.

Once treatment has begun, confirm that saline is flowing through the tubing and catheter circuit by observing the rotation of the inline flow indicator (see Figure 4.51). If the flow indicator does not rotate freely during patient treatment, inspect the entire tubing circuit for kinks or other restrictions to flow. Tapping on the flow indicator will liberate any trapped air bubbles and return them to the saline bag.

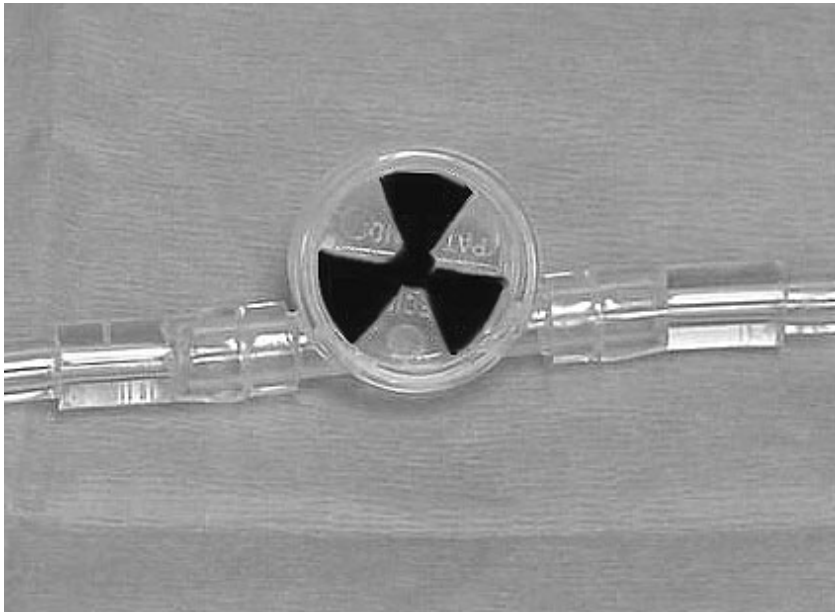

Figure 4.51. Inline Flow Indicator

WARNING. Investigate air trap alarms. If an Air Trap Fault alarm occurs, it is likely that there is a leak in the tubing circuit or the catheter has failed. Refer to Alarms and Corrective Actions on page 85 for assistance. Do not keep replenishing saline that is being rapidly depleted—a problem exists that must be immediately remedied. For additional warnings and potential risks, see Operating Life on page 13.

Setup - Variations

Setup Sequence

The Setup sequence varies depending upon the following factors:

1. The time from the last power down.
2. Whether or not you used the End Procedure menu option when you terminated the previous case.

Time From Last Power Down

If the console detects that it is less than 3 minutes since the last time it was powered down it will dispense with some of its self tests depending upon the state of the cooling engine at the time of power down. The idea being that, with such a short time, it is more likely than not that the power down was either unintentional (you tripped over the power cord) or an intentioned brief adjustment that required the console to be powered off (you moved the console to a new position).

The console will give you the option to use the last programmed settings. If you elect to do this you may still use the menu to change console settings in Standby.

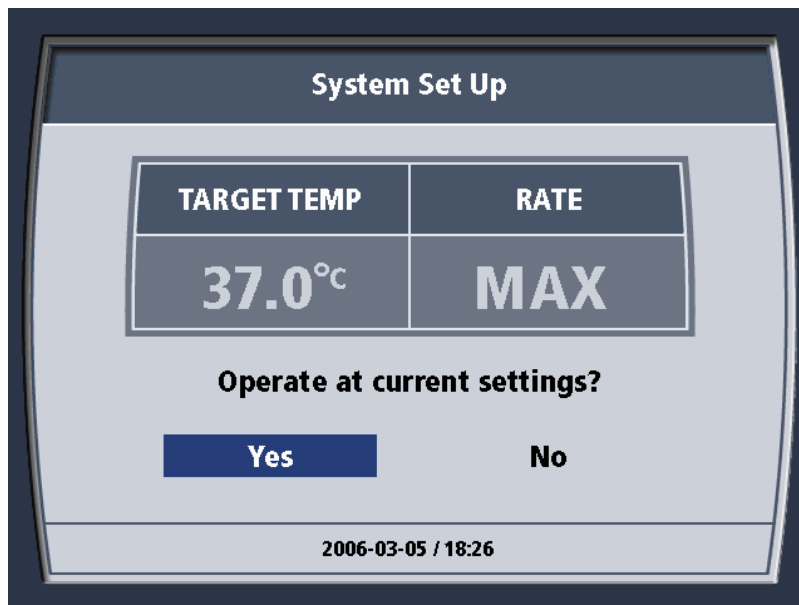

Figure 4.52. Operate at Current Settings

If it has been less than 3 minutes since the last power down, when you power on the console, the screen above is displayed.

1. If you select "Yes" and press the knob, you will proceed directly to Standby once the console self tests have completed.
2. If you select "No" and press the knob, you will continue to be presented with screens that allow you to select operating parameters for the console prior to entering Standby starting at Figure 4.55— see below.

If the console detects that it is more than 3 minutes since the last time it was powered down, it will conduct all its self tests. You will not be offered the option of operating the console at the current settings.

Downloading Data After Improper Shutdown

To help prevent the accidental loss of patient trend data, the console is designed to store patient trend data if power to the console is interrupted or lost. If the console has not been properly shut-down, all patient trend data will be preserved. The next time the console is switched on, the self-test program detects the saved patient data and offers you the option to download the data to a laptop computer. If you do not wish to download the saved data, the console will delete the data before permitting set up for a new patient.

To download patient trend data after an improper shutdown, follow these steps in the indicated order.

1. Plug in and switch on the console. The self-test screen appears on the display screen.

Note. The Software Version shown in Figure 4.53 is for reference only; the current product may use a different Software Version.



Figure 4.53. Self-Test Screen

2. When the self-test is finished, the System Set Up screen displays the message "Bath Pre-Set?"

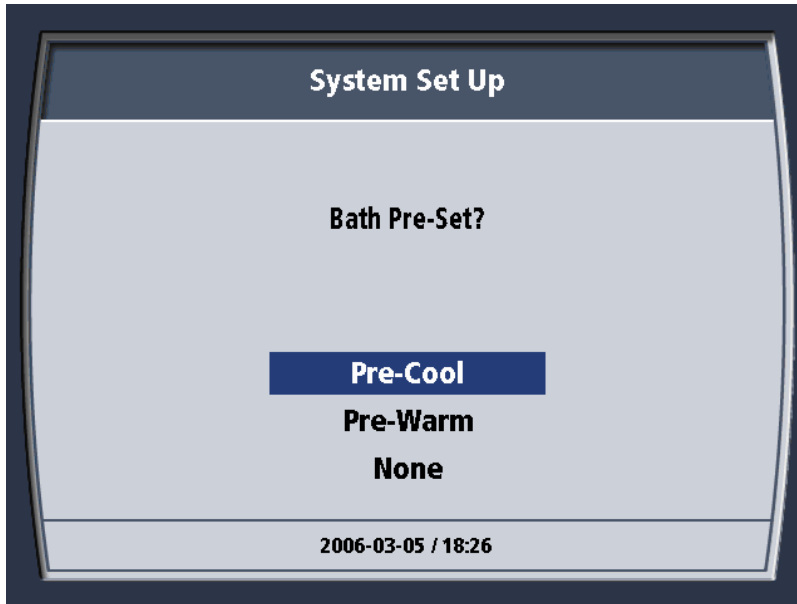

Figure 4.54. Bath Pre-Set?

3. Choose "Pre-Warm", "Pre-Cool" or "None" as desired.
4. When the console detects the presence of saved patient trend data, the System Set Up screen displays the message "New Patient?"

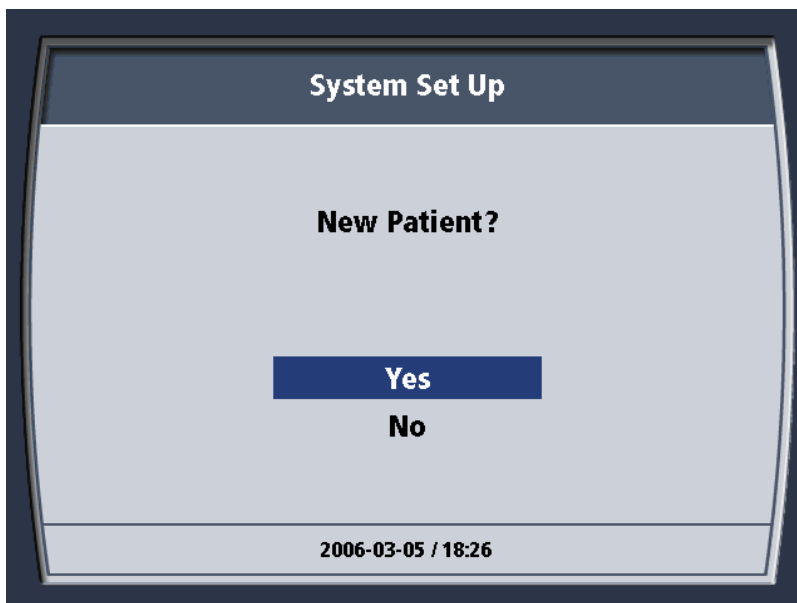

Figure 4.55. New Patient? Message

5. Choose "Yes."
6. The screen displays the message "Previous patient data must be downloaded or deleted to proceed."

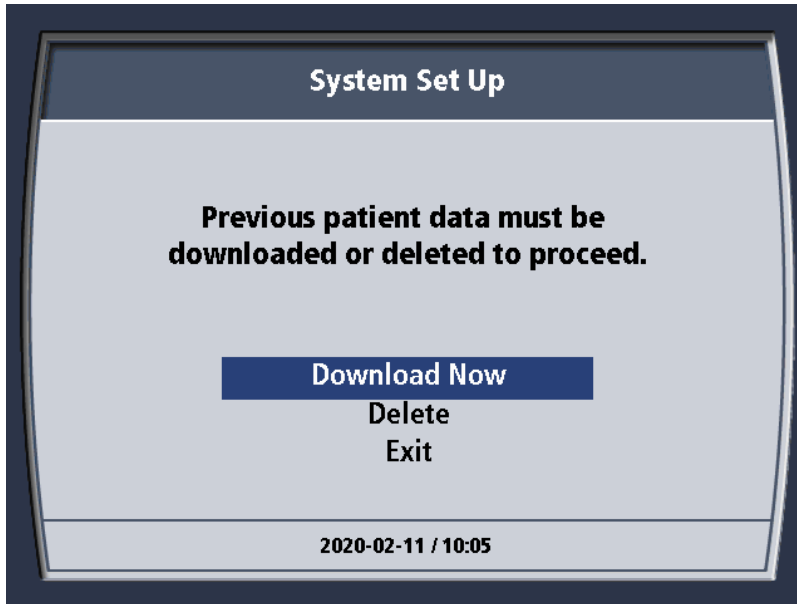

Figure 4.56. Patient Data Message

7. Choose "Download Now."
8. The screen displays the message "Prepare data link."

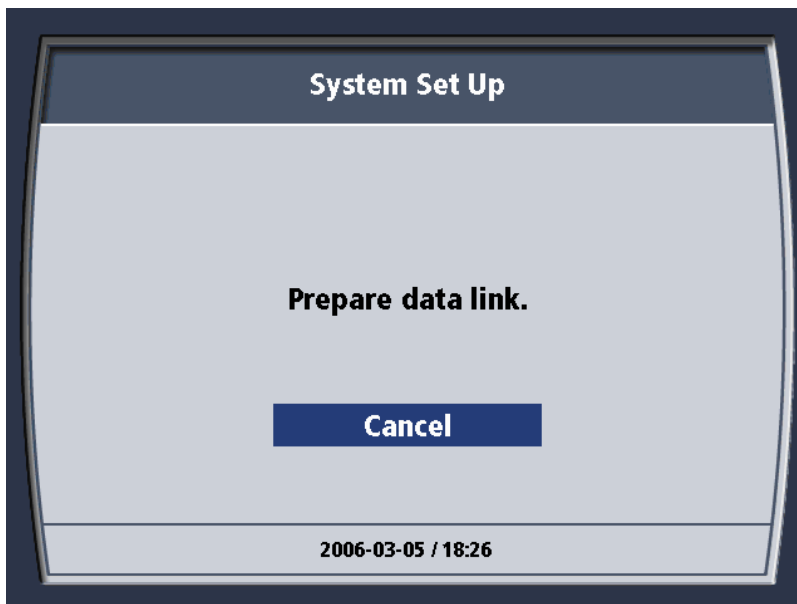

Figure 4.57. Prepare Data Link Message

9. Connect one end of a serial interface cable to the laptop computer's serial interface connector.
10. Attach the other end of the cable to the serial interface connector on the console. The 9-pin subminiature "D" connector is located on the rear of the display head.

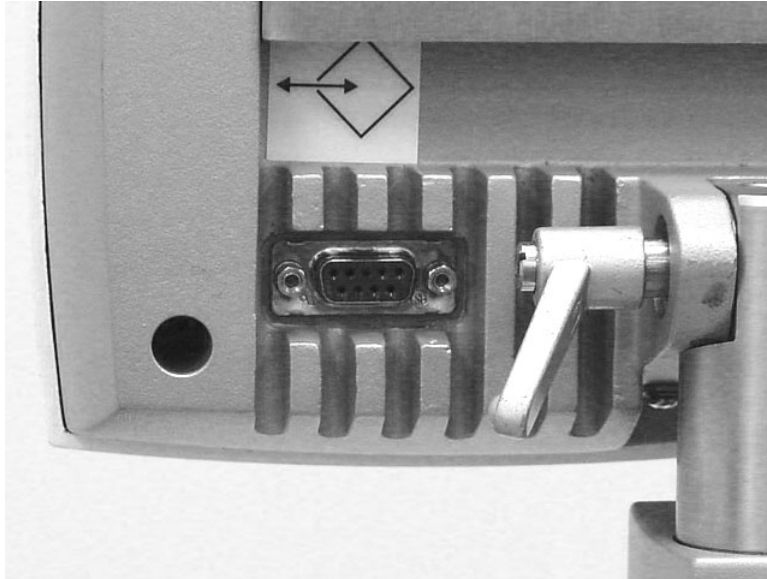

Figure 4.58. Location of the Serial Interface Connector

11. Start the TempTrend CSV program on the laptop computer. See the TempTrend CSV Instructions for Use (IFU).
12. If a problem occurs during downloading, the screen displays the message "Download error. Please check external computer." Check the serial cable connections and the operation of the laptop computer and choose "Try again." If repeated failures occur, choose "Cancel." Repeated failures indicate a problem with the TempTrend program or the console; contact your ZOLL representative for assistance.

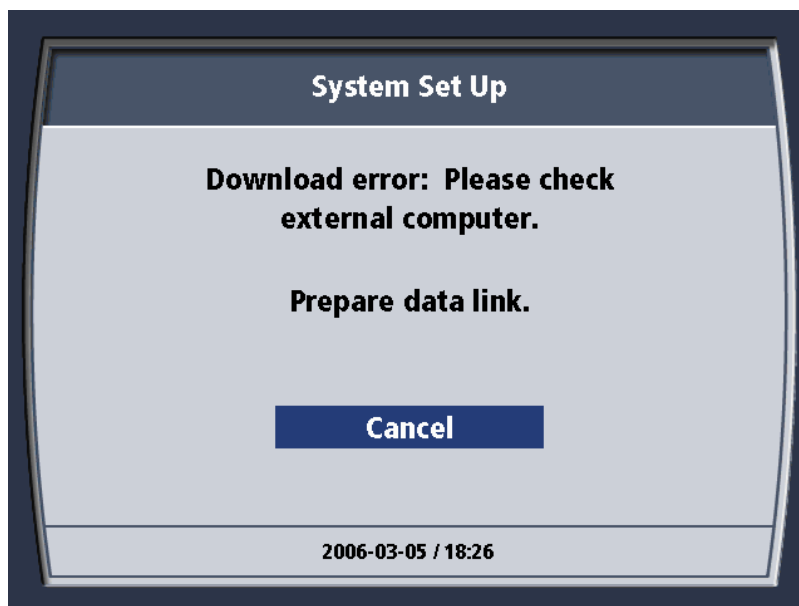

Figure 4.59. Download Error Message

13. When the data download is complete, the screen briefly displays the message "Download Complete." At this time, the patient trend data saved from the improper shutdown is deleted.
14. After about two seconds, System Set Up screen displays the message "Set up system now. Press Enter to proceed."
15. Disconnect the serial interface cable from the console and the laptop computer.

Downloading of patient trend data is now complete. To set up the console for a new patient, return to the section in this chapter titled Preparing the Console for Treatment on page 44.

Caution. There is no “Undelete”. If you choose “Delete,” the patient’s trend data will be permanently deleted and cannot be recovered later.

Ending Treatment

End Procedure

Use of the “End Procedure” menu option ensures that the patient data log is closed and cleared so that the console is ready to receive the next patient. If the “End Procedure” menu option is not used to terminate a case, then the console is programmed to ensure that you make active decisions as to what is to happen to the patient data log when you next power on the console. See “Downloading Data After Improper Shutdown” on page 61.

We refer to the use of the End Procedure menu option as “Proper Shutdown” in this manual.

Data Download

Data may be downloaded at the end of a case. To download patient trend data from the console to a laptop computer, follow these steps in the indicated order.

1. When you choose to end the procedure, the screen displays the message “Patient data must be downloaded or deleted to proceed.”

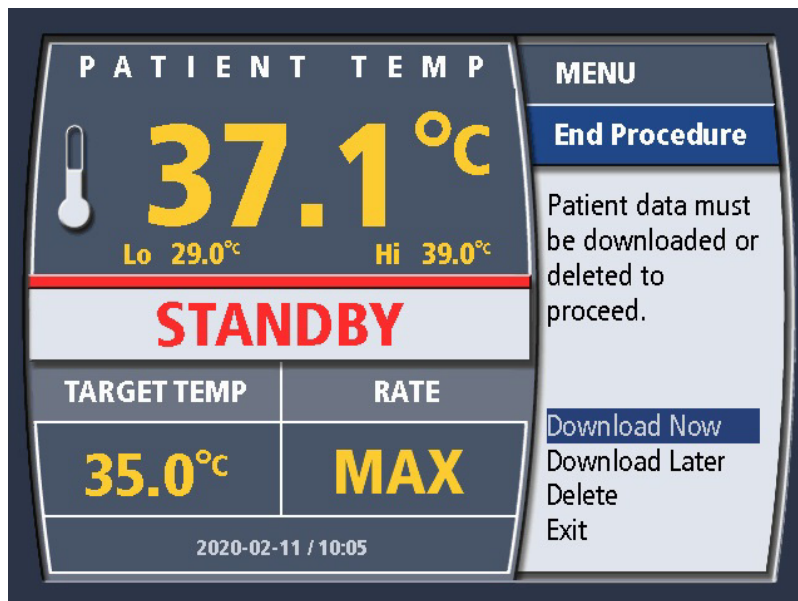

Figure 4.60. Patient Data Message

2. Choose “Download Now.”
3. The screen displays the message “Prepare data link.”

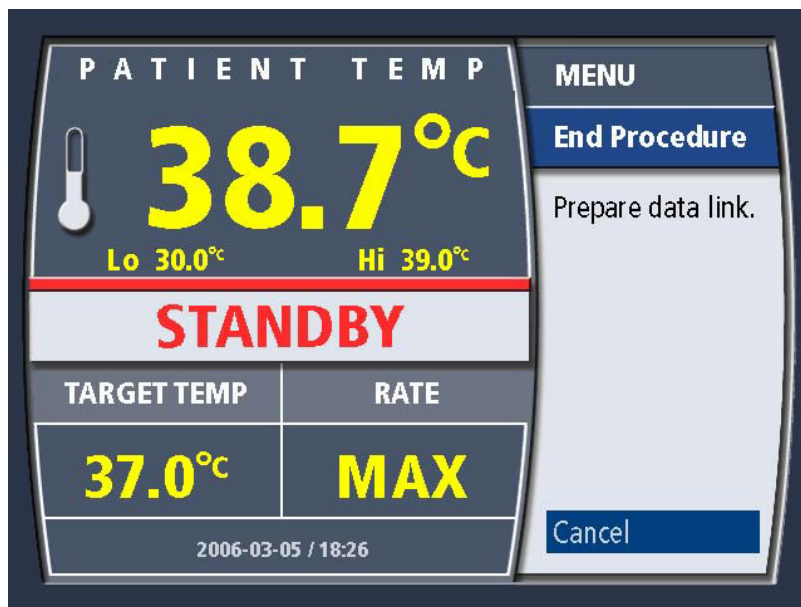

Figure 4.61. Prepare Data Link Message

4. Connect one end of a serial interface cable to the laptop computer's serial interface connector.
5. Attach the other end of the cable to the serial interface connector on the console. The 9-pin subminiature "D" connector is located on the rear of the display head.

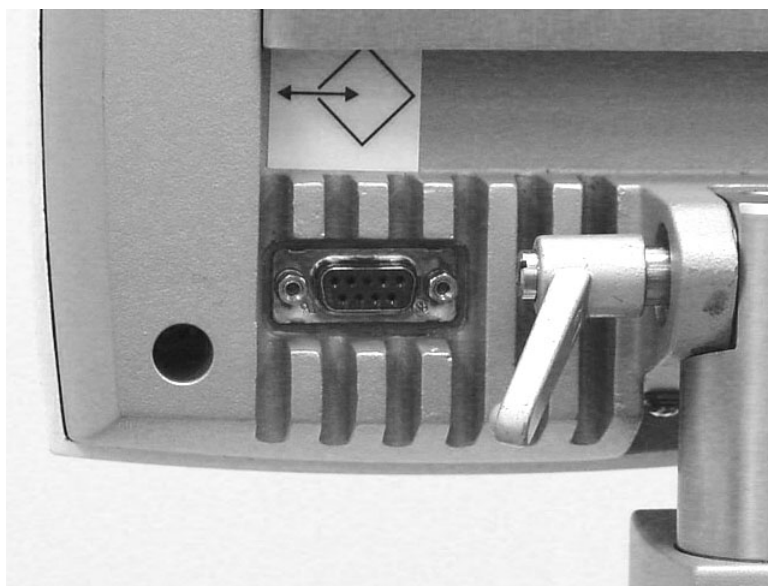

Figure 4.62. Location of the Serial Interface Connector

6. Start the TempTrend CSV program on the laptop computer. See the TempTrend CSV Instructions for Use (IFU).
7. If a problem occurs during downloading, the display screen will show the message "Download error. Please check external computer." Check the serial cable connections and the operation of the laptop computer and choose "Try again." If repeated failures occur, choose "Cancel." Repeated failures indicate a problem with the TempTrend program or the console; contact your ZOLL representative for assistance.

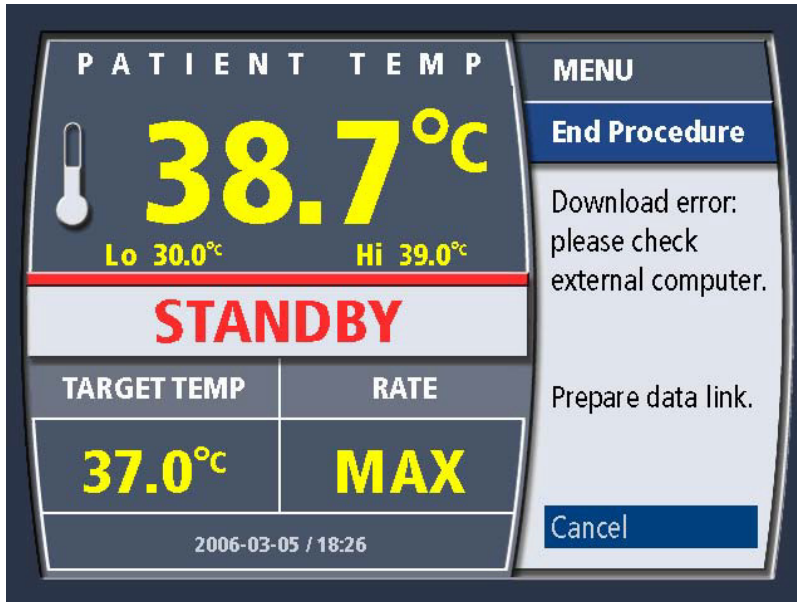

Figure 4.63. Download Error Message

8. When the data download is complete, the display screen briefly displays the message "Download Complete."
9. If you are downloading data after treatment has ended, the patient trend data in the console will be deleted. After about two seconds, the message is automatically cleared and the screen displays the message "Turn power off".



Figure 4.64. Turn Power Off Message

10. At the rear of the console, turn the power on/off switch to OFF.
11. Disconnect the serial interface cable from the console and the laptop computer. Patient trend data downloading is now complete.

New Patient – No Power Down

Change the Start-Up Kit

The console does not have to be powered down to start a new case. A new catheter, patient temperature probe and Start-Up Kit are required for each patient – see Disposal of Used Components on page 68. To immediately start a new case without powering down:

1. Place the console in Standby.
2. Delete the previous Patient Data – see below.
3. Verify the System Settings.
4. You may select to Pre-Cool or Pre-Warm the coolant using the settings menus.
5. Connect the New Patient.
6. Place the console in Run when desired.

Delete Previous Patient Data

To delete a previous patient's data and prepare the console for immediate use with a new patient without powering off, follow these steps in the indicated order:

1. Press the Press for Menu/Enter knob once. The menu is displayed.
2. Turn the knob until New Patient is highlighted. Press the knob once to enter the selection.
3. The New Patient menu appears. The screen displays the message "Previous patient data must be downloaded or deleted to proceed." Turn the knob until Delete is highlighted. Press the knob once to enter the selection.
4. The screen displays the message "Are you sure you want to delete the previous patient data?" Press the knob once to enter Yes.
5. The screen briefly displays the message "Previous patient data deleted" and then displays the Standby screen.

Disposal of Used Components

WARNING. Single-use device – do not reuse. ZOLL intravascular heat exchange catheters and Start-Up Kit components are single-use devices and may not be reprocessed or reused. The cyclical stresses of the roller pump on the catheter and Start-Up Kit cause fatigue failures. **Do not use catheters or Start-Up Kits beyond the labeled usage time. The product will fail.**

Caution. Avoid contact with used components. Handle used components as medical waste.

To remove used components from the console and dispose of them properly, follow these steps in the indicated order.

1. Ensure that the patient has been disconnected from the console and that the power switch has been turned off.
2. Cross connect the loose ends of the Start-Up Kit when you disconnect it from the catheter. This will reduce the amount of fluid that has to be cleaned up later.
3. Position a large empty medical waste container or collection bag near the console.
Caution. Do not disassemble Start-Up Kit. Do not disconnect the tubing connecting the components. They are removed and disposed of as a complete unit. To avoid injury, do not disconnect the saline solution container.
4. Open the top cover of the console. Open the transparent top cover of the roller pump.
5. Remove the cap from the coolant well and set it aside in a clean location.
6. Remove the insulating jacket from the saline container and set it aside.

7. Lift the handle on the pump rollers.
8. Grasp the pump tubing and gently pull it up and out of the channel while rotating the pump head.
9. Pull the tubing out of the pump head. Press the handle down onto the rollers until it press into the detent and close the top cover of the roller pump.
10. Loosely coil the disconnected ends of the catheter tubing.
11. Lift the heat exchange coil out of the coolant well. Hold the coil above the coolant well to allow coolant to drip back into the well.
12. Pull the air trap up and out of the chamber.
13. Unhook the saline solution container from the hook.
14. Bundle up the collection of components, still connected together, and gently deposit them in the medical waste container. Take care to avoid contact with the IV container "spike."
15. Use a disposable tissue to wipe up any spilled coolant from the top of the coolant well. Place the tissue in the medical waste container.
16. Replace the insulated cap on the coolant well. Replace the insulating jacket on the hook.

Removal and disposal of the used components is complete. The console may now be stored or moved to its next treatment location.

Note. Disposal of console. When the console itself has reached the end of its useful life, it must be disposed of in accordance with local governing ordinances and recycling plans for refrigerated appliances.

Temperature Trend Data

Overview

During operation, the console continuously collects and stores temperature trend data, storing a record each minute. This data is stored in memory and can be downloaded to an attached laptop computer for later analysis or plotting.

Data can be collected for 21 days before the memory is filled. Periodic data download and deletion is recommended to preserve all of the stored data. If data is not downloaded before the memory is full, the oldest data will be overwritten by the latest data and only the latest 21 days of data saved.

At any time during operation, the complete record of temperature trend data can be displayed as a graph on the screen. This chapter explains how to display temperature trend data and provides details about the format and structure of the downloaded data.

Displaying the Temperature Trend Graph

To display the temperature trend graph, follow these steps:

1. Press the Press for Menu/Enter knob once. The screen displays the menu. The selection "View Graphs" will be highlighted.

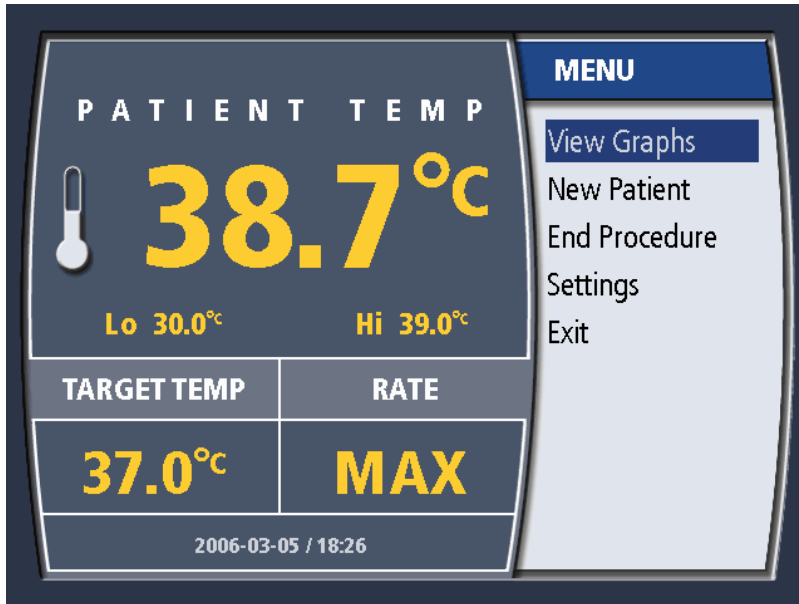

Figure 4.65. Menu

2. Press the knob once. The screen will display the temperature trend graph.

Temperature Trend Graph

Temperature trend data can be displayed as an interactive graph on the screen. The display is a time-series of patient temperature (from the primary temperature probe) and console activity, plotted in two graphs. The patient temperature graph plots temperature vertically and time horizontally. The console activity graph plots cooling/warming activity vertically and uses the same time scale horizontally. An example of the patient temperature trend display is shown below.

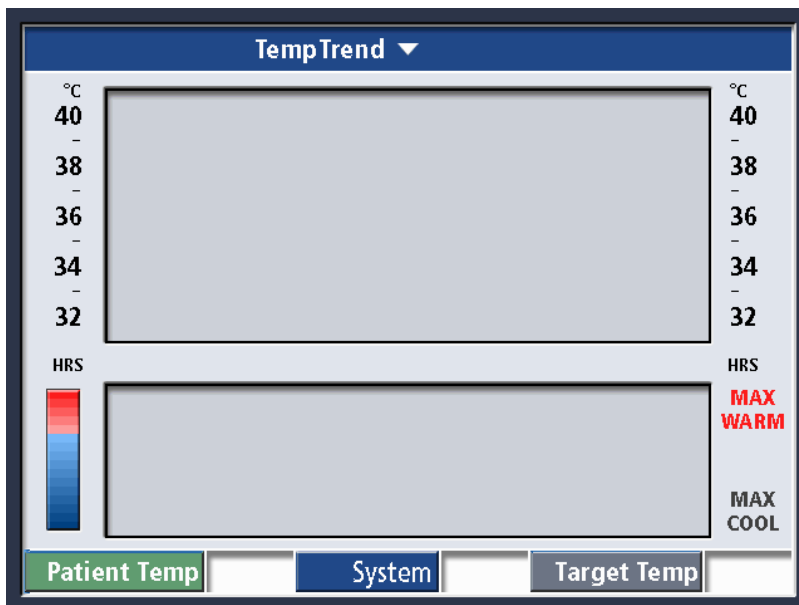

Figure 4.66. Temperature Trend Display

Patient Temperature

The patient temperature graph (labeled "Patient Temp") is scaled for any temperature between 31°C and 41°C (87.8°F– 105.8°F). The time scale can be set to any of four intervals (refer to Setting the Time Scale on page 72 for details). Figure 4.66 shows the vertical temperature displayed in degrees Celsius, and the horizontal time scale displayed for a 4-hour interval.

System Activity

The System activity graph (labeled "System") is scaled for any console activity, from maximum cooling to maximum warming. The horizontal time scale is the same as that set for the Patient Temperature graph. The vertical scale uses a colored activity indicator:

- The red zone indicates coolant temperatures between 36°C and 42°C.
- The neutral point (between red and blue) indicates coolant temperature of 36°C and also indicates when the pump is not operating.
- The blue zone indicates coolant temperatures between 0°C and 36°C.

Cursor

The cursor is a fixed vertical line that runs through the center of both graphs. When the temperature trend graph is displayed, you may turn the Press for Menu/Enter knob to scroll the display screen to the left or right. As data scrolls under the cursor, the top of the display screen shows the time and date of the data under the cursor.

Turn the knob clockwise to scroll to the right. As you scroll to the right, the time and date display will indicate later data. By scrolling right to the end, you can display the most current data.

Turn the knob counterclockwise to scroll to the left. As you scroll to the left, the time and date display will indicate earlier data. By scrolling left to the end, you can display the data collected when treatment began.

Status Bar

Across the bottom of the display screen is a status bar which displays the patient's temperature, the status of the console, and the target temperature for the data point under the cursor.

The patient's temperature and target temperature are displayed using the current temperature notation setting (Celsius or Fahrenheit).

The status field uses colors to display one of nine status messages that are described in the following table.

Status Message	Message Color	Explanation
STBY	Black	The console was in Standby mode (pump off).
MAX	Red	The console was warming.
MED	Red	
LOW	Red	
0	Black	The console was neither warming nor cooling.
LOW	Blue	The console was cooling.
MED	Blue	
MAX	Blue	
OFF	Black	The console was turned off.

Table 4.6. Status Bar Messages

Setting the Time Scale

The time scale displayed by the temperature trend graph can be set to any of four intervals: 4 hours, 12 hours, 24 hours, or 72 hours. To set the time scale, follow these steps:

1. Display the temperature trend graph.
2. Press the Press for Menu/Enter knob once. The screen displays a pop-up menu with the choice "Set Time Scale" highlighted.

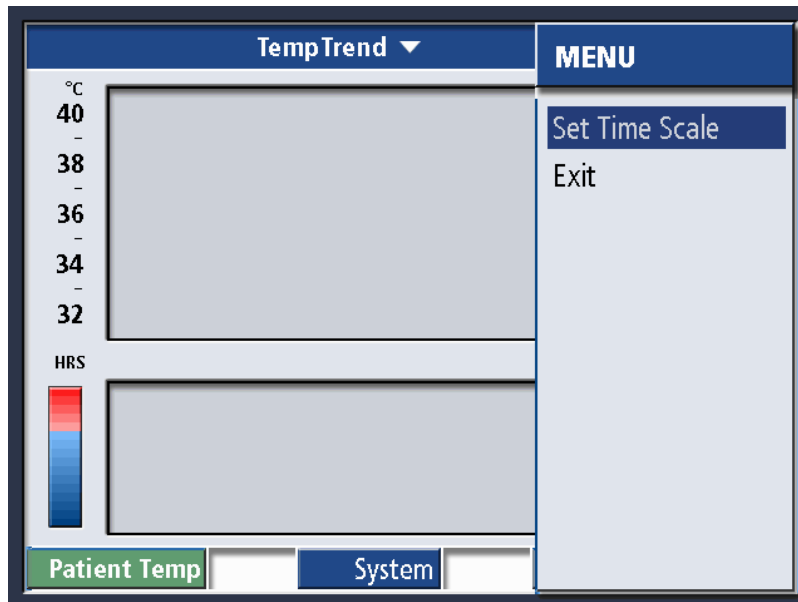

Figure 4.67. Set Time Scale

3. Press the knob once. The screen displays the message "Select interval" followed by four interval choices. The most recent choice will be highlighted.

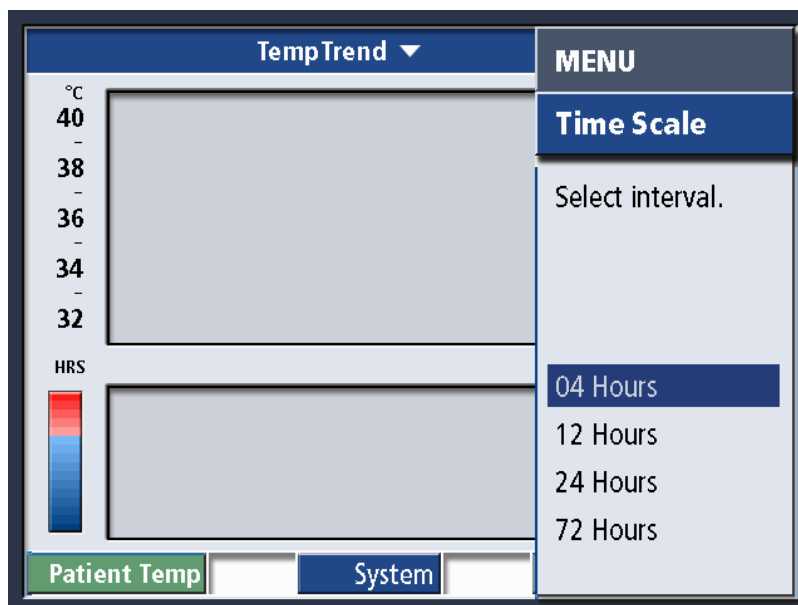

Figure 4.68. Select Interval

4. Turn the knob to highlight your desired selection. When it is highlighted, press the knob once.

5. The screen displays the pop-up menu again. Turn the knob to highlight the "Cancel/Exit" selection.
6. Press the knob once. The menu will disappear and the temperature trend graph will be displayed using the interval you selected.

Mechanical Components

Top Cover

When access to the tubing or coolant well of the console is required, lift the top cover to a fully upright position.



Figure 4.69. Top cover fully open

Display Head Tilt

To modify the tilt of the display head, or to lock the display head in place use the lever located at the swivel point. Turn the lever clockwise to tighten or counterclockwise to loosen. The position of the lever may be changed, without adjusting the tightness, by pulling the lever towards you.

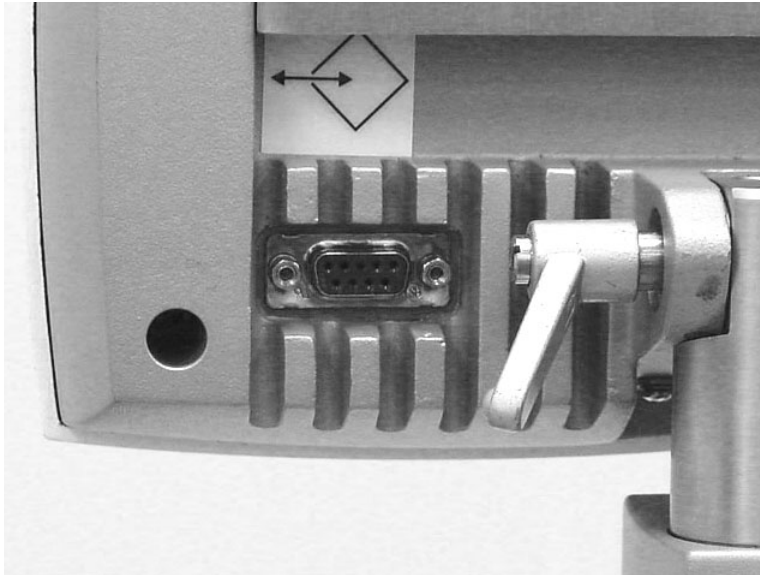

Figure 4.70. Display Head Tilt Lever

Casters

There are two different types of casters (wheels) on the console.

1. The front casters have a longer latch to engage the lock.
2. The rear casters have a shorter latch to engage the lock.

Figure 4.71 shows the location of the casters.

1. Front Casters
2. Rear Casters

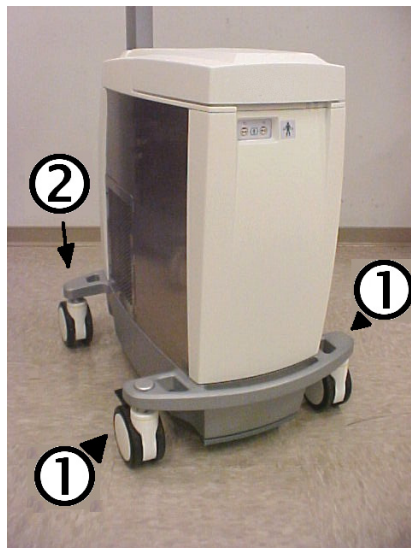

Figure 4.71. Casters on the console

Hospital Monitor Interface Accessory (HMIA)

Overview

This explains the installation, operation, and maintenance of the Hospital Monitor Interface Accessory (HMIA).

The sole function of the HMIA module is to simulate the patient temperature probe connected to the T1 port on the front of the console. Connection of the HMIA to a hospital monitor using one of the ZOLL custom cables will permit the display of an identical patient temperature on both the console and the hospital monitor, while using only a single patient temperature probe.

WARNING. The HMIA is not a replacement for the T2 Temperature probe on the console. It simply simulates the T1 Temperature probe. Use of the HMIA does not obviate the need for a second patient temperature monitoring method. Failure to use a second patient temperature monitoring method can result in injury to the patient in the event of a T1 Temperature Probe failure.

Operating the HMIA

Connecting to the Hospital Monitor

The HMIA simulates a standard YSI-400 temperature sensor, such as in a patient temperature sensing Foley catheter or rectal probe.

The HMIA is connected to a hospital monitor via a ZOLL custom interface cable included with the HMIA. These cables have connectors that are identical to the connectors of Foley and rectal patient temperature probes.

One end of the ZOLL interface cable plugs directly into the standard patient cable of the hospital monitor. In this way, the hospital monitor connects to the HMIA interface cable in the same fashion as it would connect to a Foley or rectal temperature probe. (See Figure 4.72).



Figure 4.72. Cables and Connections

The other end of the ZOLL interface cable plugs into the HMIA connector labeled T1 out. (See Figure 4.73).

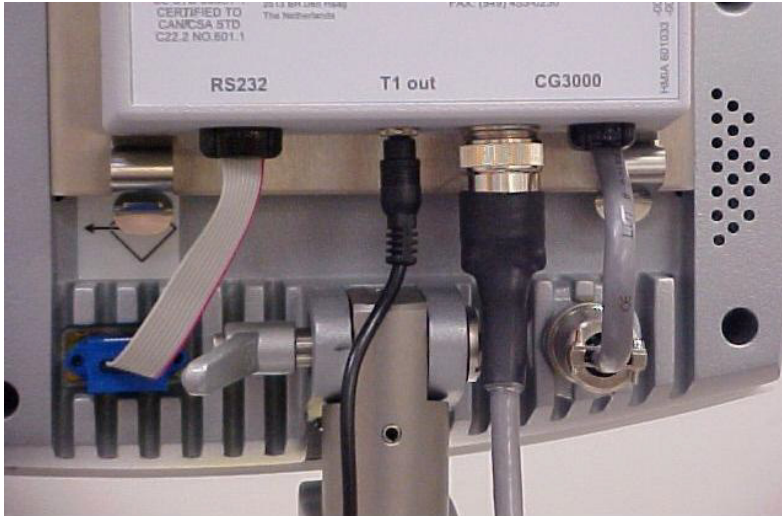

Figure 4.73. HMIA with T1 out connection

To begin operation

The operation of the HMIA is very simple. There is no independent on/off switch. As soon as the console is switched on, the HMIA automatically begins functioning.

Connect the custom ZOLL interface cable to the patient cable of the hospital monitor. (See Figure 4.72). Plug the other end of the ZOLL interface cable into the HMIA connector labeled "T1 out".

The set-up is now complete.

Controls and indicators on the HMIA

The HMIA has the following control/indicators: a reset switch, a green power indicator and a red warning light.

The front panel of the HMIA is illustrated in Figure 4.74.

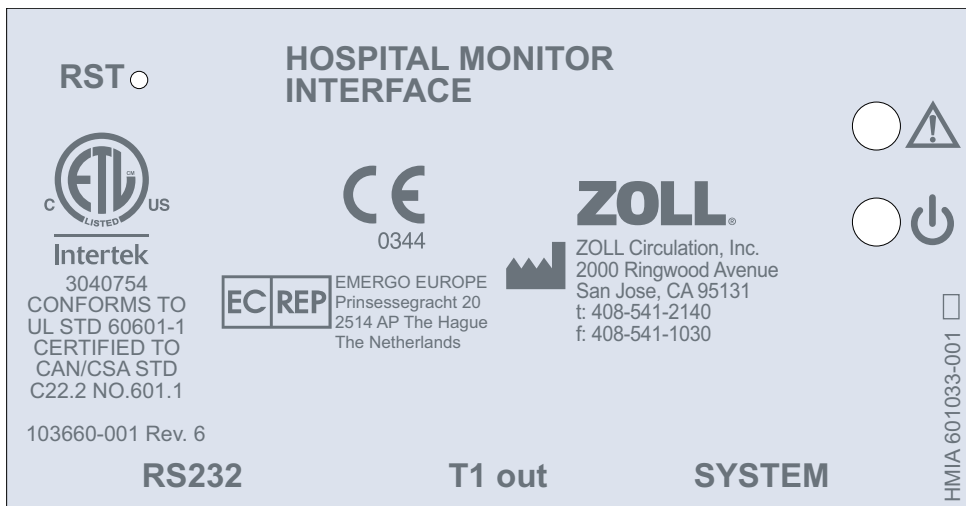

Figure 4.74. Front Panel of the HMIA

The meaning of the symbols on the front panel is as described in the table below



Symbol	Description	Function
RST	Reset Button	This is a reset button. Lightly push the tip of a paper clip, or similar sized device, into the hole until you feel a "click" and then withdraw the paper clip.
	Caution LED	This red light indicates that there is a malfunction in the HMIA.
	Power LED	This green light indicates that the HMIA is receiving power from the console.
RS232	RS-232 Serial port connector cable	This short extension cable is connected to the RS-232 data port connector on the back of the display head.
T1 out	Patient temperature output connector	This connector accepts the custom ZOLL interface cable.
SYSTEM	Console umbilical cord connections	One connector is attached to the round, multi-pin connector on the back of the display head via a short cable. The other connector mates with the umbilical cord of the console.

Table 4.7. HMIA Control/Indicators

Operating States

The HMIA has the following operating states: Start-up and Run.

Start-up

When the console is powered on, illumination of the Green LED is indication that power has been supplied to the HMIA. If there is no power to the HMIA the Green LED is not lit and the hospital monitor, if attached to the HMIA, should detect this as a probe disconnection or temperature probe error.

Once powered, the HMIA immediately establishes its link with the console and performs a series of self tests including self-calibration – see below.

Run

The HMIA is designed to provide a variable resistance value that is interpreted by YSI-400 compliant hospital monitors as patient temperature. The patient temperature is obtained via the T1 connection of the console.

Calibration

HMIA performs a self-calibration at Start-up. It will also perform a self-calibration upon reconnection of the RS-232 port (for example, you might temporarily disconnect the HMIA to allow access for data download). Self-calibration takes less than half a second. During self-calibration, it may be detected by the hospital monitor as a disconnected probe. At the end of self-calibration the HMIA will automatically return to Run.

Installation

The HMIA is quickly and easily installed.

Prior to installation of the HMIA, verify that the console has the correct software to support the HMIA. The software version is displayed during initial start-up of the console per Figure 4.75. The first number in the Software Version must be equal to or greater than 1.04 (See Figure 4.75).



Figure 4.75. Console Software Version

If your console does not have the compatible software version, then the correct software will need to be installed for the HMIA to function. Failure to install the correct software prevents the HMIA from functioning but it has no adverse affects on the console.

Installation Equipment

The following items are necessary to install a HMIA.

1. Console with correct software.
2. Hospital Monitor Interface Accessory (HMIA)
3. TP-400 test fixture with adapter cable that mates to the T1 connector of the console
4. Air trap assembly filled with water.
5. The standard Hospital Monitor patient temperature cable that is used to connect the Hospital Monitor to a Foley or rectal patient temperature sensor.
6. Hospital Monitor that conforms to the YSI-400 requirements.
7. Optionally a Digital Multimeter may be used if a hospital monitor is not available.

Installation Procedure

1. Disconnect power to the console.
2. Disconnect the Umbilical Cable from the rear of the display head (See Figure 4.76).



Figure 4.76. The Hirose Connector – Rear of the Display Head

3. Verify that the connector type on the end of the Umbilical Cable is identical to the connector on the HMIA. If the connectors are incompatible then contact ZOLL.
4. Remove the paper protecting the Velcro strips found on the mounting surface of the HMIA.
5. Hang the HMIA on the stainless steel bracket located on the back of the display head. The connectors on the HMIA should be facing downward.
6. Press on the lower half the HMIA until the snaps engage.
7. Connect the Umbilical Cable to the mating connector on the HMIA labeled SYSTEM.
8. Connect the cable with the circular connector to the mating connector on the rear of the display head.

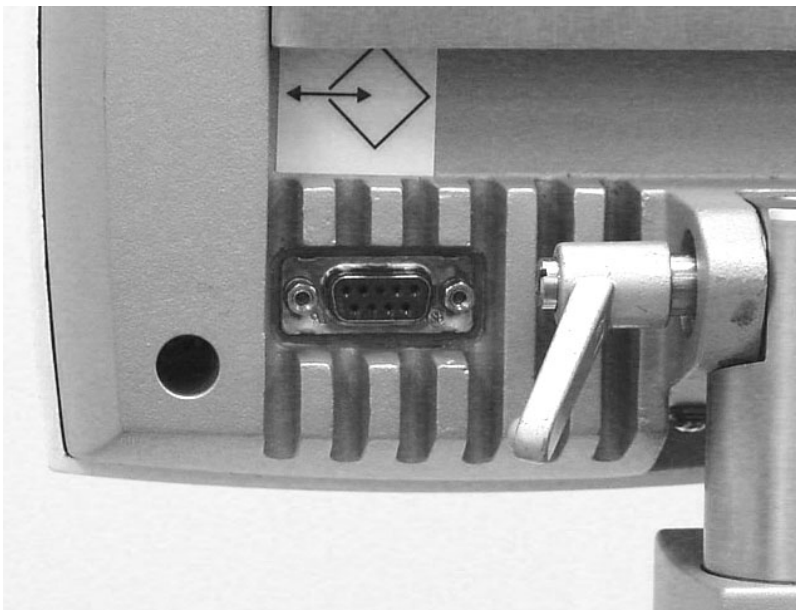

Figure 4.77. RS-232 Connector – Rear Display Head

9. Connect the HMIA RS232 connector, labeled RS232, to the mating connector on the rear of the display head. (See Figure 4.77.)

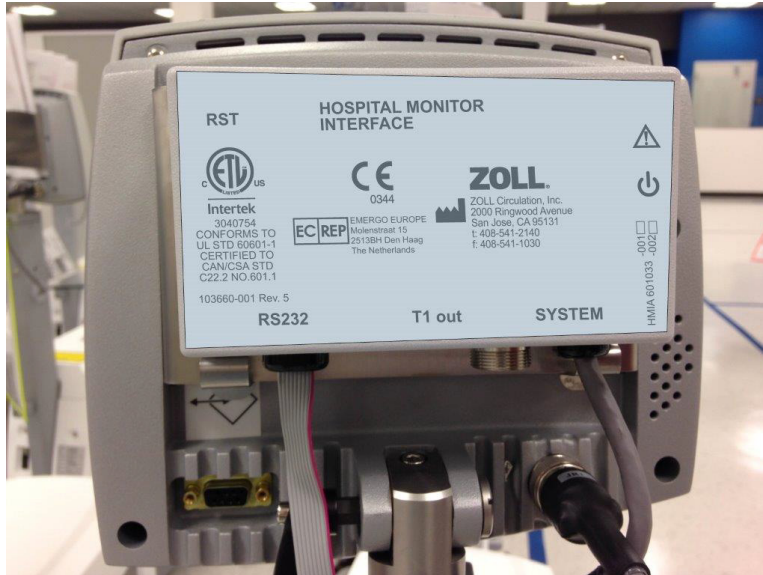

Figure 4.78. Installed HMIA – Rear Display Head

10. Select the appropriate custom ZOLL interface cable that mates with the patient cable of the hospital monitor.
11. Insert the phone jack of the selected cable into the HMIA connector labeled T1 out.
12. Connect the other end of the ZOLL interface cable to the patient cable of the hospital monitor.
13. Prepare the hospital monitor such that it will monitor patient temperature.
14. Power ON the console.
15. Verify that the Green LED of the HMIA is ON.
16. Connect a TP-400 temperature simulator to the T1 connection on the front of the console. Set to 35°C.
17. Using an air trap test fixture to complete the set-up procedure, place the console in Standby.
18. Verify that the patient temperature displayed by the console is also displayed on the hospital monitor +/- 0.1°C.

Note. There may be a delay, as long as 2 minutes, before the temperature displayed by the hospital monitor agrees, within +/- 0.1°C, with the temperature displayed by the console.
19. Set the TP-400 to 38°C.
20. Verify that the patient temperature displayed on the console screen is also displayed on the hospital monitor +/- 0.1°C.
21. Remove the TP-400 and verify that the hospital monitor recognizes the loss of patient temperature. Typically the hospital monitor will indicate that the probe is disconnected.
22. Reconnect the TP-400
23. Verify that the patient temperature shown on the display screen is also displayed on the hospital monitor +/- 0.1°C.
24. Power off the console.
25. Verify that the hospital monitor recognizes the lack of input. Typically the hospital monitor will indicate that the probe is dislodged.
26. The console with the HMIA module is now available for clinical use.

Removal of the HMIA

To remove the HMIA, simply apply the installation instructions in reverse beginning with step 12.

Connection Cable Part Numbers

The following connection cables are available to allow the connection of the HMIA to your hospital monitor. If you have another type of connector or do not know which connector to use, please contact ZOLL Customer Service.

Part Number	Connects to
500628-001	Monitors using a 3.5mm phone jack (Bard®)
500629-001	Monitors using a 2.5mm phone jack (Terumo®)
500630-001	Monitors using a 2-pin Molex type connector with socket contacts (Mallinckrodt® or Smiths Medical®)
500631-001	Monitors using a 2-pin Molex type connector with pin contacts (Rüsch®)
500632-001	Monitors using an RCA type Phono plug (GE®, WelchAllyn® or Mallinckrodt®)

Table 4.8. Connection Cable Part Numbers

Data Download

You may download data from the console at any time. Simply disconnect the HMIA RS-232 connector from the RS-232 port on the back of the display head. Then download data per the instructions in the TempTrend CSV IFU.

This procedure will not delete the data from the console. The data is simply copied from the console to the laptop.

Reconnect the HMIA RS-232 connector when you have finished.

You cannot damage the HMIA by mistakenly “downloading data” into it.

The HMIA does not store data.

Note. When you disconnect the HMIA RS-232 connector from the display head, the HMIA will stop sending data to your hospital monitor. The hospital monitor will detect this as a patient disconnection or a very low patient temperature. Depending upon the set-up of your hospital monitor, this may or may not result in a patient temperature alarm on the hospital monitor.

Troubleshooting

The HMIA has a very limited user interface. The only function of the HMIA is to simulate the patient temperature probe connected to the T1 input port of the console.

This troubleshooting guide deals only with the HMIA. It is incumbent on the technician doing troubleshooting to verify Items 1 through 4 below prior to troubleshooting of the HMIA:

1. The console is powered on, operational, and reporting a valid temperature on the display screen.
2. The hospital monitor is on and operational.
3. The hospital monitor conforms to the YSI-400 specifications.
4. All cables are connected.
 - a. RS232 from the HMIA to the display head.
 - b. The circular connector on umbilical cable of the console is plugged into the HMIA.
 - c. The HMIA is attached to the circular connector on the display head.
 - d. The hospital monitor is connected to one end of the ZOLL interface cable of the HMIA.
 - e. The other end of the ZOLL interface cable is connected to the HMIA.

Errors

Green LED OFF

The Green LED indicates that power is present on the HMIA circuit board.

If the Green LED is not on then the LED has either burned out or the internal power connector is dislodged. Return the HMIA to ZOLL for service.

Flashing Red LED

The Red LED flashes only when there is a problem with the CPU or the internal self-calibration fails. Using a small solid wire (paper clip), press the reset button (RST). If the Red LED continues to flash return the HMIA to ZOLL for service.

No Temperature Reported On Hospital Monitor

1. Observe Red LED.
2. If it is flashing then follow instructions for Flashing Red LED above.
3. If the Red LED is not flashing then disconnect the hospital monitor from the HMIA interface cable.
4. Using a DMM measure the resistance between the two pins.
5. Using the chart YSI-400 Temperature vs. Resistance on page 83 determines if the resistance value measured corresponds to the temperature displayed on the display screen.
6. If the resistance value is correct then the HMIA is functioning to specifications.
7. If the resistance value is wrong, then test ZOLL interface cable for shorts or opens.
8. If it passes the test, then press the reset button (RST).
9. Repeat step 5 above.
10. If the resistance value is still wrong, then disconnect the RS232 cable from the rear of the display head, wait for 15 seconds and then reconnect.
11. Wait for an additional 20 seconds for the HMIA to re-establish communication with the console
12. If the resistance value is wrong then return the HMIA to ZOLL for service.

Incorrect Temperature Reported On Hospital Monitor

1. Disconnect the hospital monitor from the HMIA interface cable.
2. Using a DMM measure the resistance between the two pins.
3. Using the chart YSI-400 Temperature vs. Resistance on page 83 determines if the resistance value measured corresponds to the temperature displayed on the display screen.
4. If the resistance value is correct then the HMIA is functioning to specifications.
5. If the resistance value is wrong, then test ZOLL interface cable for shorts or opens.
6. If it passes the test, then press the reset button (RST).
7. Wait for 20 seconds and then repeat step 3 above.
8. If the resistance value is still wrong, then disconnect the RS232 cable from the rear of the display head, wait for 15 seconds and then reconnect.
9. Wait for an additional 20 seconds for the HMIA to re-establish communication with the console
10. If the resistance value is wrong then return the HMIA to ZOLL for service.

Temperature jumps between 26°C and 49°C On Hospital Monitor

There has been an internal component failure. Return the HMIA to ZOLL for service.

YSI-400 Temperature vs. Resistance

Temperature		Resistance (ohms)
°F	°C	
77.0	25	2252
78.8	26	2156
80.6	27	2064
82.4	28	1977
84.2	29	1894
86.0	30	1815
87.8	31	1739
89.6	32	1667
91.4	33	1599
93.2	34	1533
95.0	35	1471
96.8	36	1412
98.6	37	1355
100.4	38	1301
102.2	39	1249
104.0	40	1200
105.8	41	1152
107.6	42	1107
109.4	43	1064
111.2	44	1023
113.0	45	983.8
114.8	46	946.2
116.6	47	910.2
118.4	48	875.8
120.2	49	842.8
122.0	50	811.3

This page intentionally left blank.

5. Alarms and Corrective Actions

Overview

This chapter lists alarm messages that may appear on the console display during operation. If an alarm occurs, refer to the following table for information about the cause and corrective actions you can take to remedy the problem.

Please note that in many cases the console will automatically restart when the condition that generated the alarm has been cleared. In other cases, you must take corrective action and then restart the console.

WARNING. When treating a patient with the console, appropriately qualified medical staff must routinely and closely monitor the patient. Audible and visual alarm signals generated by the console require the authorized individual to remain in close proximity to the patient throughout the procedure.

Note. Alarm priorities. In accordance with the IEC 60601-1-8:2006 safety standard, the console alarms have been categorized as High, Medium, and Low priority. High priority alarms are indicated by red flashing text on the display and require prompt attention from the operator to prevent irreversible injury or death. Medium priority alarms are indicated by a yellow banner and require attention from the operator to prevent reversible injury or discomfort to the patient. Low priority alarms are displayed with a yellow banner and delay the treatment of the patient until they are addressed by the operator.

Alarms and Corrective Actions

Alarm messages are grouped according to their priority.

Alarm Message	Cause	Corrective Action
Hi PATIENT TEMPERATURE ALARM	The patient's temperature is above the programmed Hi patient temperature alarm value.	The console alarm will reset when the patient's temperature falls below the programmed Hi patient temperature alarm value.
Lo PATIENT TEMPERATURE ALARM	The patient's temperature is below the programmed Lo patient temperature alarm value.	The console alarm will reset when the patient's temperature rises above the programmed Lo patient temperature alarm value.

Table 5.1. High priority Alarm Messages, Causes, and Corrective Actions

Alarm Message	Cause	Corrective Action
AIR TRAP FAULT¹	Air has been detected in the air trap.	Verify that the air trap is completely filled with saline. Inspect tubing circuit for leaking saline. Refer to Air Entry Into the Tubing Circuit on page 10. If the problem persists, discontinue use and contact your ZOLL service representative.
	The air trap is full of saline but the saline level detector indicates a fault.	<ol style="list-style-type: none"> 1. Completely dry the outside of the air trap with a towel to remove any condensation. 2. Wipe clean the inner surface of the air trap chamber before reinserting the air trap. 3. Verify that the air trap is seated firmly at the bottom of the air trap chamber. 4. If the problem persists, discontinue use and contact your ZOLL service representative.
COOLANT EMPTY¹	The coolant well is empty.	Fill with coolant (ZOLL-approved 50% propylene glycol / 50% deionized water mixture) until liquid level reaches the MAX line.
COOLANT LOW	The coolant level is low.	
PRIMARY TEMPERATURE PROBE DISCONNECTED¹	The primary patient temperature probe is disconnected.	Verify position of primary temperature probe. Ensure that primary probe is plugged into socket T1, or if an interconnect cable is used, the probe is plugged into the cable and the cable is plugged into T1.
PRIMARY TEMPERATURE PROBE DISLODGED¹	Temperature output from the primary patient temperature probe changed by -0.2°C or more within 10 seconds.	Replace probe in patient.
ROLLER PUMP LID OPEN¹	The roller pump lid is open.	Close the roller pump lid.
PUMP FAILURE¹	The pump has failed.	Inspect the pump. Clear any obvious faults and restart. If the problem persists, discontinue use and contact your ZOLL service representative.
SECONDARY TEMPERATURE PROBE DISCONNECTED¹	The secondary temperature probe is disconnected.	Verify position of secondary temperature probe. Ensure that the secondary probe is plugged into socket T2, or if an interconnect cable is used, the probe is plugged into the cable and the cable is plugged into T2.
SECONDARY TEMPERATURE PROBE DISLODGED¹	Temperature output from the secondary patient temperature probe changed by -0.2°C or more within 10 seconds.	Verify position of secondary temperature probe.

Table 5.2. Medium priority Alarm Messages, Causes, and Corrective Actions

TEMPERATURE PROBES DO NOT AGREE¹	Temperature outputs from the primary and secondary patient temperature probes differ by more than 2°C.	Determine the cause of the discrepancy and correct it. One or both temperature probes may need to be replaced.
SYSTEM MALFUNCTION¹	May be caused by a variety of failures.	Discontinue use and contact your ZOLL service representative.

Table 5.2. Medium priority Alarm Messages, Causes, and Corrective Actions (continued)

1. Stops operation of the console.

Alarm Message	Cause	Corrective Action
DOWNLOAD ERROR. PLEASE CHECK EXTERNAL COMPUTER	Patient trend data download has failed or there is no computer connected to the console.	Check the connection between the computer and the console and select "Try again." If problem persists, select "Cancel" and contact ZOLL technical support.
PATIENT DATA LOG FULL. PLEASE DOWNLOAD NOW	Patient trend data log is full. Only two hours of space remain.	Download patient trend data. If data is not downloaded, it will be overwritten.

Table 5.3. Low priority Alarm Messages, Causes, and Corrective Actions

This page intentionally left blank.

6. Troubleshooting

Overview

Note. Important. Qualified medical personnel must read and understand these instructions before performing troubleshooting on the console.

This chapter provides information about performing troubleshooting and service for the console. A table of symptoms, probable causes, and recommended corrective actions has been provided to assist troubleshooting by qualified users.

Some test and repair tasks must be performed only by ZOLL-trained service personnel. If you encounter a problem that is not listed in this chapter, do not attempt to make repairs or adjustments—contact your ZOLL service representative for assistance.

Warranty and Service on page 99 provides information about how to obtain assistance or service from a ZOLL representative.

Symptoms and Remedies

Consult the following table for help with troubleshooting the console. If the problem you are experiencing is not listed in the table, contact your ZOLL service representative for assistance.

Symptom	Probable Cause	Corrective Action
Red LED on control panel is illuminated and audible alarm sounds.	Console or control failure.	Discontinue use and contact ZOLL.
Red LED on control panel is blinking and audible alarm beeps repeatedly.	Electrical power was momentarily interrupted.	Turn off power and wait 30 seconds. Turn on the console and restart. If problem persists, discontinue use and contact ZOLL.
Console will not start.	No electrical power.	Verify that the console is plugged into a working circuit of correct capacity. Ensure that the power cord is securely plugged into the power inlet connection of the console.
The patient does not cool. The activity monitor indicates "MAX COOLING" and the patient's temperature is increasing.	The patient may be febrile.	The fever has overcome the cooling capability of the catheter. Use additional patient cooling methods as needed until the patient's temperature is stabilized.
	The temperature controller setting is incorrect.	Verify the target temperature, and that the cooling rate option is not used.
	The saline flow is obstructed—indicated by no rotation of the flow indicator.	Inspect the entire length of tubing, from the patient's catheter connection to the console and back to the patient. Clear all restrictions. Check the flow indicator to confirm flow.
	The catheter is improperly positioned or is not connected.	Place and position the catheter as directed by the Instructions for Use. Connect the saline circuit tubing to the catheter and prime the saline circuit.

Table 6.1. Symptoms, Probable Causes, and Corrective Actions

The patient does not cool. The activity monitor indicates "MAX COOLING" and the patient's temperature is increasing.	The heat exchange coil is not in the coolant well.	Place the heat exchange coil in the reservoir.
	The console is not operating within specifications.	Contact your ZOLL service representative.
The patient does not cool. The activity monitor does not indicate "MAX COOLING" and the patient's temperature is increasing after 45 minutes of sustained activity.	The console is not operating within specifications.	Download the TempTrend data file. If the coolant temperature is above 42°C, contact your ZOLL service representative.
The patient's temperature is more than 0.5°C below the set point.	The patient's resistance to hypothermia has diminished.	Monitor the patient's temperature. If the patient's temperature drops more than one degree below the target temperature, ensure that the console is operating normally. If the coolant temperature is at or below the patient's temperature, the activity monitor should indicate warming and the pump should be off. Use warming blankets to stabilize the patient's temperature.
	Machine malfunction.	See above for correct machine function. Use conventional methods to rewarm the patient and discontinue use of the console.
The patient does not stop cooling. The activity monitor indicates "MAX COOLING" when the target temperature has been reached.	A cooling or temperature controller fault has occurred.	If the activity monitor indicates "MAX COOLING" and the patient's temperature is one degree below the target temperature, discontinue treatment and contact ZOLL.
The patient is warming (when set for cooling).	A cooling or temperature controller fault has occurred.	If the target temperature is below the patient's temperature, and the activity monitor does not indicate cooling activity, discontinue treatment and contact ZOLL.
The patient does not warm. The activity monitor indicates "MAX WARMING" and the patient's temperature continues to decline.	The warming capacity of the catheter has reached its upper limit.	Use warming blankets to supplement catheter performance until the patient's temperature has been stabilized.
The patient is warming too fast (when set for warming).	The warming rate is incorrect.	Reset the target temperature to hold or cool the patient's temperature. Verify the warming rate setting.

Table 6.1. Symptoms, Probable Causes, and Corrective Actions (continued)

Events Requiring Technical Assistance

Caution. The console has multiple internal alarm states - see Alarms and Corrective Actions on page 85.

As described in this manual, some are remedied by the user action e.g. Filling the coolant well with coolant will rectify the coolant level alarm.

There are others that may be alleviated, in some cases, by power cycling the console (i.e. turning it off and then back on).

If neither user action nor power cycling the console clears the alarm – **Do not use the console.** Call a ZOLL Service Representative for service of any alarm that does not clear.

Immediately discontinue using the console and seek advice from your ZOLL service representative if any of the following events occur:

- The console repeatedly trips an outlet equipped with a ground fault circuit interrupter (GFCI).
- The protective fuse repeatedly blows.
- Fluid is observed leaking from the console.
- The console emits an unusual odor when operating.
- The console produces loud or unusual noises when operating.
- The display screen, control knob, or control buttons fail to operate as expected.
- The console has been exposed to fire, flood, or hazardous substances.
- The console has suffered potential damage due to improper storage, rough handling, or being dropped.

This page intentionally left blank.

7. Maintenance

Overview

To ensure safe operation and a long service life, the console must be periodically maintained. This chapter describes the scheduled and unscheduled maintenance tasks that must be performed by the user.

Scheduled maintenance tasks must be performed at least as frequently as recommended in this chapter. If your console is subject to very long periods of continuous use, you may be required to perform these tasks more frequently than the schedule recommends.

The frequency of performing unscheduled maintenance tasks depends upon the manner in which you use the console. Most of these tasks are performed when an inspection indicates that they are necessary, or after a problem is discovered.

Failure to perform the maintenance tasks listed in this chapter may cause degraded performance of the console or may reduce the operating life of its parts.

To ensure safe operation of the console, preventive maintenance and service, including a comprehensive technical inspection and electrical safety test, is required annually. Contact your local sales representative for information on preventive maintenance pricing and complete service packages available in your region.

WARNING. No user-serviceable parts inside the console. Only ZOLL-authorized personnel may service and repair the console.

Safety Precautions

Required personal protective equipment (PPE)

- Safety glasses
- Latex or neoprene gloves

Required tools and materials

- Phillips screwdriver
- Screwdriver
- Inspection lamp or flashlight
- Vacuum cleaner with crevice tool

Scheduled Maintenance

The following table lists scheduled maintenance tasks for the console. Detailed procedures for some of these tasks are listed later in this chapter.

Item	Frequency	Maintenance Task
Coolant well	Before each use	If necessary, inspect and refill with coolant (ZOLL-approved 50% propylene glycol / 50% deionized water mixture) until liquid level reaches the MAX line.

Table 7.1: Scheduled Maintenance

Condensate pan	After each use	Inspect. Empty condensate if necessary (refer to Clean Console and Condensate Pan on page 95).
Refrigeration condenser filter	Every 6 months	Inspect the filter and replace if necessary (refer to Inspect/Replace Condenser Filter on page 94).
Roller pump	Monthly	Clean rollers and tubing path with cloth moistened with water. Clean rollers and apply light lubricating oil if rollers have been in contact with saline solution.
	Annually	Verify the pump roller gap.
Coolant	Annually	Drain and refill with new coolant mixture.
Power cord	Annually	Inspect for wear or damage.
Temperature accuracy	Annually	Perform a temperature accuracy test (refer to Temperature Accuracy Test on page 95).

Table 7.1: Scheduled Maintenance (continued)

Note. Infection control. 50% propylene glycol coolant has been evaluated for antimicrobial effectiveness and determined not to promote growth of gram negative rods, gram positive cocci, or yeast microbes. 50% propylene glycol was found to be comparable to 70% isopropyl alcohol.

Unscheduled Maintenance

The following table lists unscheduled maintenance tasks for the console. These tasks should be performed when indicated. Detailed procedures for some tasks are listed later in this chapter.

Item	Criteria	Maintenance Task
Console	When deterioration is evident	Inspect mechanical and electrical components for wear and loose or deteriorated parts. Verify continuity of the electrical ground connection.
Console	When soiled	Clean the exterior of the console (refer to Clean Console and Condensate Pan on page 95).
Coolant	If contaminated	Drain coolant, clean the coolant well, and refill with new coolant (refer to Table 7.1, "Scheduled Maintenance," on page 93 and Drain Coolant on page 96).
	If particulate matter is observed in the coolant	

Table 7.2: Unscheduled Maintenance

Inspect/Replace Condenser Filter

Required Tools and Materials

You will need a Phillips screwdriver, an inspection lamp, and a vacuum cleaner with a crevice tool to perform these tasks.

Procedure

To inspect and replace the condenser filter, perform these steps in the indicated order:

1. Ensure that the console has been switched off and the power cord has been disconnected.
2. Use a screwdriver to release the screws securing the access door. Remove the access door from the panel.
3. Remove and inspect the filter. Replace it if it is clogged with dust.

4. Use the inspection lamp to inspect the area in and around the condenser. Look for accumulations of dust and debris.
5. If necessary, use the vacuum cleaner's crevice tool to remove dust from the condenser. Gently pass the crevice tool over all exposed surfaces of the condenser only. Take care not to bend any of the cooling fins of the condenser. Never use cleaning fluids or water on the condenser.
6. When finished, replace the access door and secure the screws.
7. Inspection and cleaning are complete. The console may be returned to service.

Temperature Accuracy Test

Required Tools and Materials

You will need a calibrated temperature source (e.g., Fogg System Co. model TP-400 or equivalent).

Procedure

To perform a temperature accuracy test, follow these steps in the indicated order:

1. Set the calibrated temperature source to exactly 37° C and plug it into connector T1.
2. Start the console and proceed to the Standby screen.
3. Observe the patient temperature displayed on the screen. It should indicate 37° C ± 0.2° C.
4. If the displayed temperature is above or below the indicated range, contact your ZOLL service representative.
5. If the displayed temperature was within the indicated range, the test is complete.

Clean Console and Condensate Pan

Required Tools and Materials

You will need a soft, lint-free cloth and a solution of mild detergent and water to perform these tasks.

Procedure

To clean the console, follow these steps in the indicated order:

1. Ensure that the console has been switched off and the power cord has been unplugged.
2. Clean the exterior of the console using a soft cloth dampened with a mild detergent and water mixture. Never use solvents or abrasive cleaners on the console. Avoid vigorous scrubbing, especially on the front surface of the display.

Note. Console disinfection. To disinfect the console, use a product that includes at least 55% isopropyl alcohol or other approved non-corrosive hospital-grade disinfectant (where regionally available, ZOLL recommends PDI® Super SANI-CLOTH® germicidal disposable wipes, EPA Reg. No: 9480-4). ZOLL highly recommends testing the disinfectant on a small area on the outer surface of the console prior to wiping all surfaces of the console. Follow directions provided by the manufacturer of the disinfectant. The hospital determines the effectiveness of the disinfectant.

3. Wipe down the outside surfaces with a water-dampened cloth to remove remaining spots or residue.
4. Slide out and remove the condensate collection pan from under the front of the console (see Figure 7.1).

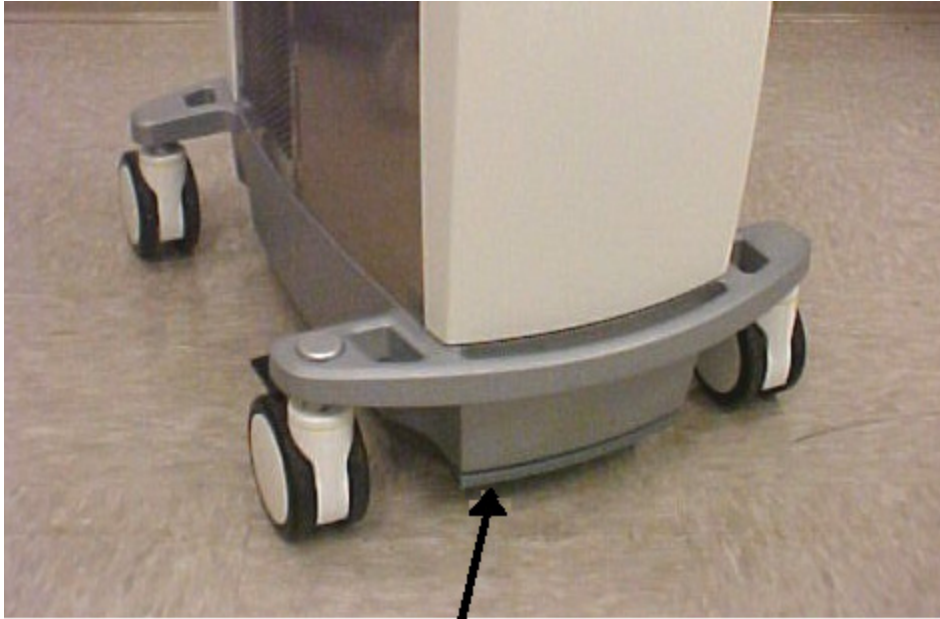

Figure 7.1. Location of Condensate Pan (see arrow).

5. The pan may be washed in hot soapy water. Never use solvents or abrasive cleaners on the pan. Dry the pan when finished and reinstall it in the console.

Note. Do not operate the console without a condensate collection pan properly installed. Failure to do so may allow water to accumulate on the floor under the console.

Drain Coolant

It may become necessary to drain and clean the coolant well because the coolant has become contaminated, or to prepare the console for shipment.

Required Tools and Materials

You will need the drain line and connector assembly (supplied with the console), and a 2-liter waste container to perform this task. Drain the coolant in an area where spills can be managed appropriately.

Procedure

To drain the coolant well, follow these steps in the indicated order.

1. Unplug the console.
2. Remove the cap on the coolant well and set it aside on a clean surface.
3. Visually inspect the coolant well for discolorations or foreign matter.
4. Remove the front panel of the console by pulling the panel straight away from the front of the machine (no tools are required to remove the panel). Near the bottom left corner of the console is a drain hose held by a clamp and the drain coupler.

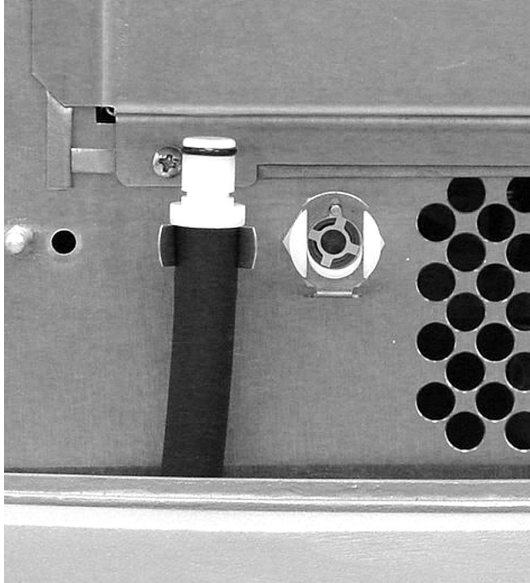

Figure 7.2. Drain Hose and Drain Coupler

5. Place the open end of the drain hose into a suitable container or position it above a floor sink or drain.
6. Push the connector on the drain hose into the drain coupler on the coolant well (refer to Figure 7.3).



Figure 7.3. Push Hose Into Drain Coupler

7. As soon the connector is firmly seated in the coupler, coolant will automatically begin to flow through the line.
8. Wait until the coolant flow has stopped. Disconnect the drain line by pressing down on the metal tab on the coupler. Gently pull out the drain hose.
9. Dispose of the used coolant.
10. Wipe the coolant well dry. Visually inspect the drained coolant well for discolorations or foreign matter.
11. Thoroughly wipe the coolant well with at least 55% isopropyl alcohol or other non-corrosive hospital-grade disinfectant.
12. Rinse the coolant well with coolant. Do not rinse with saline.

13. Reconnect the drain hose as described in steps 4-7 and drain the liquid used for cleaning. Dispose of the liquid.
14. Rinse the coolant well with coolant. Refer to Table 7.1, "Scheduled Maintenance," on page 93.
15. When cleaning is complete, you may leave the coolant well empty (to prepare it for shipment), or refill it with coolant. Refer to Table 7.1, "Scheduled Maintenance," on page 93 and Preparing the Console for Treatment on page 44 for details.
16. Replace the cap on the coolant well.
17. Replace the drain hose in the clamp. Replace the front panel on the console.

Spillage

Both saline and coolant are corrosive and electrically conductive. Although the console is designed and tested to be in compliance with the spillage protection requirements of IEC 60601-1, it is important to clean up spillage quickly:

1. To ensure a safe work environment. Spillage, especially of coolant, can result in a very slippery floor.
2. To minimize the risk of corrosion or damage to the console.

Spillage is most likely under the following conditions:

1. During set-up of the Start-Up Kit. Spillage of saline in this case should be cleaned up as with the handling of any infusion fluid.
2. During filling or emptying of the coolant well. The coolant may be safely wiped with paper towel and the towel disposed of in the standard trash. Propylene-glycol: Water mix is slippery on sealed floors.
3. In the event of an air trap alarm. With any air-trap alarm, investigate to see if there is spillage into the raceway. Remove the rotor and blot dry the raceway and motor shaft.

8. Warranty and Service

ZOLL Factory Warranty

ZOLL Medical Corporation (ZOLL) warrants to the Customer that from the date of shipment from ZOLL's manufacturing facility, the console shall be free from defects in material and workmanship under normal use for the period of one (1) year after the purchase date or the date the console is first placed in service, whichever date occurs later, not to exceed two (2) years from date of manufacturing, when the console has been properly operated, maintained, and used for its intended purpose.

During the factory warranty period, if the console requires repair, ZOLL at its sole discretion shall repair or replace the defective parts without charge to the purchaser. ZOLL reserves the right to make any necessary repair at the facilities of the purchaser, ZOLL's manufacturing facility, or at any ZOLL-authorized repair center. The warranty covers all parts, labor, and shipping costs for the repair of the console. Replacement parts may be new or remanufactured parts. Parts replaced under warranty become the property of ZOLL. If ZOLL's inspection detects no defects in material or workmanship, ZOLL's regular service charges shall apply. Replacement parts are covered during the remainder of the warranty period.

ZOLL warrants to the Customer that disposable products (including catheters, Start Up Kits, guidewires, etc.) will be free from defects in material and workmanship during the shelf life stated on the packaging or for a period of six (6) months from date of shipment, whichever comes first. During this period, the disposable shall be returned to ZOLL for assessment to confirm the defect. ZOLL, at its sole discretion, may replace the disposable found by ZOLL to be defective without charge to the purchaser. A product that is not returned to ZOLL does not qualify for replacement.

This warranty does not cover items subject to normal wear and burnout during use, including but not limited to bearings, fuses, cables, and batteries. The warranty does not apply to software included as part of the console (including software embodied in read-only memory, known as "firmware").

ZOLL shall not be responsible for any console or disposable defect, the failure to perform any specified function, or any other non-conformance caused by or attributable to: misuse, abuse, neglect or accident, failure to perform the required maintenance described in the Operation manual; any modification by the Customer, unless such modification is made with the prior written approval of ZOLL; any repair made by anyone other than ZOLL or its expressly authorized representative; use with any associated or complementary equipment, accessory or software not supplied by ZOLL; exposure to conditions beyond the environmental, power or operating constraints specified by ZOLL; or installation or application not specified by ZOLL's instructions.

This warranty does not include preventative or scheduled maintenance. This warranty shall be void if any labels or other identifying marks permanently affixed to the console or disposable when shipped by ZOLL are removed, altered, defaced or obliterated.

THE WARRANTY SET FORTH HEREIN IS EXCLUSIVE AND ZOLL EXPRESSLY DISCLAIMS ALL OTHER WARRANTIES WHETHER WRITTEN, ORAL, IMPLIED, OR STATUTORY, INCLUDING BUT NOT LIMITED TO ANY WARRANTIES OF MERCHANTABILITY OR FITNESS FOR A PARTICULAR PURPOSE. ZOLL shall have no liability whatsoever for any improper use or improper repair of the console.

Technical Support and Resources

ZOLL provides field- and factory-based technical support for its products. Our service hotline can answer questions, provide guidance, and schedule service for your console.

Upon request, ZOLL can provide circuit diagrams, parts lists, and service documentation to authorized users.

Obtaining Service from ZOLL

To obtain service from ZOLL Circulation, Inc., contact your local sales representative. For 24 hour technical support, call: +1-877-225-7487.

Packing and Shipping Instructions

Contact your local sales representative before returning items to ZOLL. Items must be packed carefully to avoid damage during shipment.

Disposal of the Console



Do not dispose of the console as unsorted municipal waste.

Dispose of the console in accordance with local regulations and in an environmentally safe manner. Use the disposal process that has been specified for your hospital or medical practice.

The functional life of the console will be best extended if you properly maintain the console. See "Maintenance" on page 93. Do not attempt to service the cooling engine yourself as this may release R134a refrigerant into the atmosphere.

The console contains:

- A CCFL bulb
- Refrigerant R134a, a green house gas

9. Specification

Specifications

Physical	
Dimensions	Height: 45 in. (114 cm) Width: 17 in. (43 cm) Depth: 30 in. (76 cm)
Weight	107 lb. (49 kg)
Electrical	
Configuration	100-120 VAC, 50/60 Hz, 5 A ¹ or 6 A ¹ .
Fuse protection	See product label
Configuration	220-240 VAC, 50/60 Hz, 2.25 A ¹ or 3 A ¹ .
Fuse protection	See product label
Environmental	
Operating temperatures	10°C – 27°C (50°F – 81°F)
Operating humidity	30% to 75% noncondensing
Atmospheric pressure	70 kPa to 106 kPa
Chiller and Heater	
Reservoir volume	2.0 liters (0.5 gal.)
Pump capacity	7 lpm at pump head
Temperature range	0° C – 42° C
Coolant	ZOLL-approved 50% propylene glycol / 50% deionized water mixture
Refrigerant	RFC 134a
Controls and display screen	
Display screen	6.4 in. (16.25 cm) LCD color VGA
Controls	Pushbuttons and knob
Temperature input	Thermistor, YSI-400 series
Articulation	180° swivel, 45° tilt
Data interface	Serial RS-232C, 9-pin sub-D connector
Alarms	Audible tones and displayed text messages
Displayed temperature range	26°C – 42°C
Displayed temperature accuracy	± 0.2°C
Saline coolant circuit	
Priming volume	200 ml
Heat exchanger	Disposable stainless steel coil

Priming source	Sterile saline solution (hospital-provided)
Patient connection	Directional Luer connections on 72 in. (183 cm) lines
Pump tubing	Roller pump compatible with directional fittings
Sterility	Gamma sterilized
Saline alarm	Reservoir level detection & alarm system
Coolant circuit operating life	Replace disposable components after seven (7) days of continuous use.
Equipment classifications	
Type of protection against moisture	Ordinary
Type of protection against electric shock	Type BF for temperature inputs Type B for catheter connections
Protection class	1
Mode of operation	Continuous
Approved Patient Temperature Probes	
Temperature probe standard	YSI-400
Compatible YSI-400 Temperature probes: Use with ZOLL temperature probe cables.	<p>Compatible YSI-400 temperature probes:</p> <ul style="list-style-type: none"> C.R. Bard Foley Catheter, BARDEX, 8F C.R. Bard Foley Catheter, BARDEX, 12F C.R. Bard Foley Catheter, LUBRI-SIL, 14F C.R. Bard Foley Catheter, LUBRI-SIL, 16F C.R. Bard Foley Catheter, LUBRI-SIL, 18F Covidien Foley Catheter with Temperature Sensor, 8F Covidien Foley Catheter with Temperature Sensor, 10F Covidien Foley Catheter with Temperature Sensor, 12F Covidien Foley Catheter with Temperature Sensor, 14F Covidien Foley Catheter with Temperature Sensor, 16F Covidien Foley Catheter with Temperature Sensor, 18F Covidien General Purpose Probe, 9F Smiths Medical Foley Probe 10F Smiths Medical Foley Probe 12F Smiths Medical Foley Probe 14F Smiths Medical Foley Probe 16F Smiths Medical Foley Probe 18F Smiths Medical G/P Rectal Probe 9F Smiths Medical G/P Rectal Probe 12F

1. See product label for your country's Amp rating.